

# Compact Catalogue



# CONTENT

## Screwdrivers



Kraftform Stainless Steel	<b>6</b>
Kraftform Plus - Series 900	<b>8</b>
Kraftform Plus - Series 300	<b>11</b>
Flagdriver Series	<b>28</b>
Screwdriving Accessories	<b>29</b>
Kraftform Micro	<b>32</b>
400 T-Handle Series	<b>39</b>
ESD Tools	<b>47</b>

## Tools for Electricians



Kraftform Stainless VDE	<b>56</b>
Kraftform 100 VDE	<b>58</b>
Kraftform Kompakt VDE Stainless	<b>65</b>
Kraftform Kompakt VDE with ratchet functionality	<b>69</b>
Kraftform Kompakt VDE	<b>71</b>
Kraftform Kompakt Turbo VDE	<b>78</b>
Kraftform 1000 VDE	<b>84</b>
Series T-handle Screwdrivers	<b>86</b>
The Zyklop Ratchet VDE and Accessories	<b>86</b>
Joker VDE Self-setting, Adjustable Spanner	<b>90</b>
Torque-indicators for Electricians	<b>91</b>
Wera 2go E 1 Tool set for electricians	<b>279</b>

## Ratchets & Accessories



1/4" Zyklop Speed	<b>94</b>
1/4" Zyklop Metal Push	<b>99</b>
1/4" Zyklop Metal Switch	<b>100</b>
1/4" Zyklop Accessories	<b>102</b>
3/8" Zyklop Speed	<b>112</b>
3/8", Zyklop Comfort Ratchet	<b>116</b>
3/8" Zyklop Metal Push	<b>118</b>
3/8" Zyklop Metal Switch	<b>120</b>
3/8" Zyklop Accessories	<b>122</b>
1/2" Zyklop Speed	<b>136</b>
1/2" Zyklop Hybrid	<b>139</b>
1/2" Zyklop Metal Push	<b>140</b>
1/2" Zyklop Metal Switch	<b>141</b>
1/2" Zyklop Accessories	<b>142</b>
Zyklop Pocket	<b>156</b>
1/2" Koloss	<b>160</b>
Zyklop Mini	<b>172</b>
Tool-Check	<b>163</b>

## Joker Wrenches & Spanners



6000 Joker Ratcheting Combination Wrenches	<b>176</b>
6001 Joker Switch Ratcheting Combination Wrenches, with Switch Lever	<b>179</b>
6002 Joker Double Open-Ended Wrenches	<b>181</b>
6003 Joker Ring Spanner	<b>181</b>
6004 Joker Self-setting, Adjustable Spanner	<b>187</b>
6005 Joker Double Open-Ended Wrenches	<b>189</b>

## L-Keys



L-Keys for Hexagon Socket Screws	<b>192</b>
L-Keys for TORX® Screws	<b>207</b>

## Kraftform Kompakt



Kraftform Kompakt Turbo	<b>214</b>
Kraftform Kompakt 10, 12	<b>215</b>
Kraftform Kompakt 20, 25, 26, 27, 28	<b>216</b>
Kraftform Kompakt 40, 41	<b>221</b>
Kraftform Kompakt 60, 62	<b>222</b>
Kraftform Kompakt 70, 71	<b>226</b>
Kraftform Kompakt 100	<b>227</b>
Kraftform Kompakt 400	<b>228</b>
Kraftform Kompakt 400 RA	<b>228</b>
Kraftform Kompakt 900	<b>231</b>
Kraftform Kompakt Stubby	<b>236</b>
Kraftform Kompakt User-Specific Sets	<b>240</b>
Bitholding Screwdrivers and Adaptors	<b>247</b>
Kraftform Kompakt with Ratchet Function	<b>234, 251</b>
Kraftform Kompakt Vario without Ratchet Function	<b>253</b>

## Roller cabinet and foam inserts



Roller cabinet	<b>258</b>
Foam inserts for roller cabinet	<b>259</b>



















## Wera 2go



Wera 2go 1 Tool Carrier	<b>276</b>
Wera 2go 2 Tool Container	<b>276</b>
Wera 2go 3 Tool Box	<b>277</b>
Wera 2go 4 Tool Quiver	<b>277</b>
Wera 2go 5 Tool Carrier	<b>277</b>
Wera 2go 6 Shoulder Strap	<b>278</b>
Wera 2go 7 High Tool Box	<b>278</b>
Wera 2go H 1 Tool Set for Wood Applications	<b>278</b>
Wera 2go E 1 Tool set for electricians	<b>279</b>
Wera 2go SHK 1 Tool set for plumbing, heating and air conditioning	<b>280</b>
Hook and Loop Fastener Strips	<b>281</b>

## Bits



	Bits for Phillips Screws	<b>284</b>
	Bits for Pozidriv Screws	<b>296</b>
	Bits for Plusminus Screws – Slotted/Phillips	<b>302</b>
	Bits for Plusminus Screws – Slotted/Pozidriv	<b>303</b>
	Bits for TORX® Screws	<b>303</b>
	Bits for TORX® B0 Screws	<b>312</b>
	Bits for TORX PLUS® Screws	<b>313</b>
	Bits for TORX PLUS® IPR Screw	<b>314</b>
	Bits for Slotted Screws	<b>314</b>
	Bits for Hexagon Socket Screws	<b>317</b>
	Bits for Hexagon Socket B0 Screws	<b>322</b>
	Bits for Square Socket Screws	<b>324</b>
	Bits for TORQ-SET® Screws	<b>327</b>
	Bits for TRI-WING® Screws	<b>328</b>
	Bits for Multi-Point Screws	<b>328</b>
	Bits for Microstix® Screws	<b>328</b>
	Bits for Spanner Screws	<b>329</b>
	Nutsetters	<b>329</b>
	Internal Thread Insertion Tool	<b>331</b>

## HOLDERS and Adaptors



Impaktor Bit Holders	<b>334</b>
Rapidaptor Bit Holders	<b>335</b>
Universal Bit Holders With Quick-Release Chuck	<b>337</b>
Universal Bit Holders With Retaining Ring	<b>338</b>
Universal Bit Holders With Stainless Steel Sleeve	<b>338</b>
Bit Holders With Adjustable Depth-Control Stop	<b>340</b>
Adaptors	<b>340</b>

## Bit Sets



Bit-Checks Impaktor	<b>346</b>
Bit-Checks Stainless	<b>349</b>
Bit-Checks / Bit-Safes BiTorsion	<b>350</b>
Bit-Checks Diamond	<b>353</b>
Bit-Checks / Bit-Safes Universal	<b>355</b>
Bit-Checks Wood	<b>363</b>
Bit-Checks Metal	<b>367</b>
Bit Sets for Special Applications	<b>368</b>

## Torque Tools



<b>Series 7400 Kraftform Torque Screwdrivers</b>	
with variable torque value adjustment	<b>376</b>
with a factory pre-set measurement value	<b>381</b>
adjustable to customer requirements within the specified measurement range	<b>386</b>
<b>Series 7500 Kraftform Safe-Torque Speed Torque Screwdrivers</b>	<b>391</b>
<b>Series Torque-indicators</b>	<b>393</b>
<b>Safe-Torque torque wrenches and accessories</b>	<b>395</b>
<b>Series Click-Torque Adjustable Torque Wrenches with Reversible Ratchet</b>	<b>398</b>
Adjustable Torque Wrenches for Right-Hand and Left-Hand Tightening	<b>406</b>
Adjustable Torque Wrenches for Insert Tools	<b>407</b>
Pre-set, Adjustable Torque Wrenches for Insert Tools	<b>411</b>
<b>Insert Tools Series</b>	<b>413</b>
<b>Accessories</b>	<b>425</b>

## Impact Driver



Impact Driver 90 Nm	<b>426</b>
---------------------	------------

## Index

Techlex	<b>427</b>
Code No. Index	<b>431</b>
Article No. Index	<b>446</b>





# Screwdrivers

## Kraftform Stainless - stainless steel to prevent rust

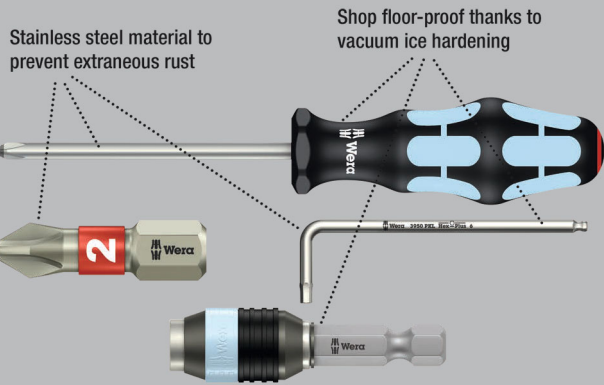

High quality Kraftform Plus screwdriver out of stainless steel. The stainless tools from Wera are vacuum ice-hardened and have the hardness and strength needed for screw connections. They can be used for industrial application without hesitation. The Lasertip tip literally bites into the head of the screw and thereby prevents any slipping out of the screw head. Multi-component Kraftform handle for fast and low-fatigue working.

Take it easy Tool Finder: colour coding according to profile and size. The hexagonal anti-roll feature prevents any bothersome rolling away at the workplace.

- Multi-component Kraftform handle for fast and ergonomic screwdriving
- Take it easy tool finder: colour coding according to profile and size
- Hexagonal anti-roll feature against rolling away
- Lasertip tips for more secure fit in the screw head

## Lasertip - laser engineered blade

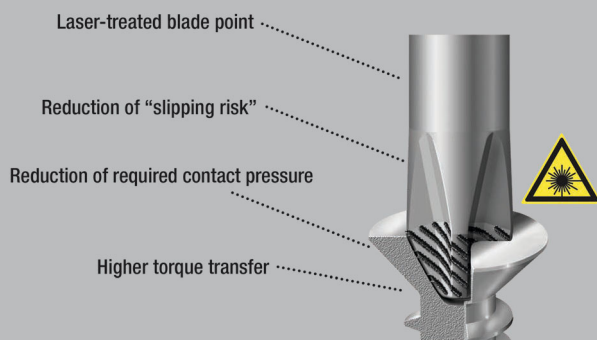

### 3335 Screwdriver for slotted screws, stainless



	EAN							
<b>Code</b>	4013288	mm	mm	mm	mm	mm	mm	
05032001001 <sup>1)</sup>	107329	0,5	3,0	3,0	80	81	1/8"	10
05032002001 <sup>1)</sup>	107336	0,6	3,5	3,5	100	81	9/64"	10
05032003001	107343	0,8	4,0	4,0	100	98	5/32"	10
05032004001	107350	1,0	5,5	5,5	125	98	7/32"	10

<sup>1)</sup>without Lasertip

### 3334 Screwdriver for slotted screws, stainless

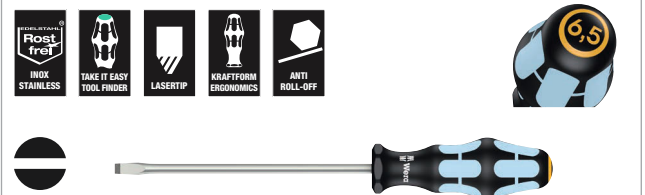

	EAN							
<b>Code</b>	4013288	mm	mm	mm	mm	mm	mm	
05032005001	107367	1,2	6,5	6,0	150	105	1/4"	10
05032006001	107374	1,2	8,0	7,0	175	112	5/16"	10
05032007001	107381	1,6	10,0	9,0	200	112	3/8"	5

### 3350 PH Screwdriver for Phillips screws, stainless



	EAN							
<b>Code</b>	4013288		mm	mm	mm	mm	mm	
05032020001 <sup>1)</sup>	107398	PH 0	60	81	3,0	2 3/8"		5
05032021001	107404	PH 1	80	98	4,5	3 1/8"		10
05032022001	107411	PH 2	100	105	6,0	4"		10
05032023001	107428	PH 3	150	112	8,0	6"		5

<sup>1)</sup>without Lasertip

### 3355 PZ Screwdriver for Pozidriv screws, stainless



	EAN						
Code	4013288		mm	mm	mm		
05032030001 <sup>1)</sup>	107435	PZ 0	60	81	3,0	2 3/8"	5
05032031001	107442	PZ 1	80	98	4,5	3 1/8"	10
05032032001	107459	PZ 2	100	105	6,0	4"	10
05032033001	107466	PZ 3	150	112	8,0	6"	5

<sup>1)</sup>without Lasertip

### 3367 Screwdriver for TORX® screws, stainless



	EAN						
Code	4013288		mm	mm	mm		
05032050001	107473	TX 8	60	81	3,5	2 3/8"	10
05032051001	107480	TX 9	60	81	4,0	2 3/8"	10
05032052001	107497	TX 10	80	81	4,0	3 1/8"	10
05032053001	107503	TX 15	80	98	4,0	3 1/8"	10
05032054001	107510	TX 20	100	98	4,5	4"	10
05032055001	107527	TX 25	100	105	5,0	4"	10
05032056001	107534	TX 27	115	105	5,5	4 9/16"	10
05032057001	107541	TX 30	115	105	6,0	4 9/16"	10
05032058001	107558	TX 40	130	112	7,0	5 3/16"	10

### 3368 Screwdriver for square socket screws, stainless

- Stainless screwdriver for square socket screws
- Multi-component Kraftform handle for fast and ergonomic screwdriving
- Handle markings simplify finding and sorting of tools
- Hexagonal anti-roll feature against rolling away
- Stainless against extraneous rust

### 3368 Screwdriver for square socket screws, stainless



	EAN						
Code	4013288		mm	mm	mm		
05032070002	114150	# 1	80	98	4,5	3 1/8"	10
05032071002	114167	# 2	100	105	6,0	4"	10

### 3334/6 Screwdriver set, stainless and rack

- Storage rack for wall-mounting

### 3334/6 Screwdriver set, stainless and rack



Code	EAN			
05032060001	111388			1
			<b>3350 PH</b> 1x PH 1x80; 1x PH 2x100	
			<b>3335</b> 1x 0,5x3,0x80 <sup>1)</sup> ; 1x 0,8x4,0x100; 1x 1,0x5,5x125	
			<b>3334</b> 1x 1,2x6,5x150	

<sup>1)</sup>without Lasertip

### 3334/3355/6 Screwdriver set, stainless and rack

- Storage rack for wall-mounting

### 3334/3355/6 Screwdriver set, stainless and rack



Code	EAN			
05032061001	111395			1
			<b>3355 PZ</b> 1x PZ 1x80; 1x PZ 2x100	
			<b>3335</b> 1x 0,5x3,0x80 <sup>1)</sup> ; 1x 0,8x4,0x100; 1x 1,0x5,5x125	
			<b>3334</b> 1x 1,2x6,5x150	

<sup>1)</sup>without Lasertip

### 3334/3350/3355/6 Screwdriver set, stainless and rack

- Storage rack for wall-mounting

### 3334/3350/3355/6 Screwdriver set, stainless and rack



Code	EAN		
05032063001	111739		1
		⊕ 3350 PH 1x PH 1x80; 1x PH 2x100	
		⊕ 3355 PZ 1x PZ 1x80; 1x PZ 2x100	
		⊖ 3335 1x 0,5x3,0x80 <sup>1)</sup>	
		⊖ 3334 1x 1,2x6,5x150	

<sup>1)</sup>Without Lasertip

### Wera Chiseldriver

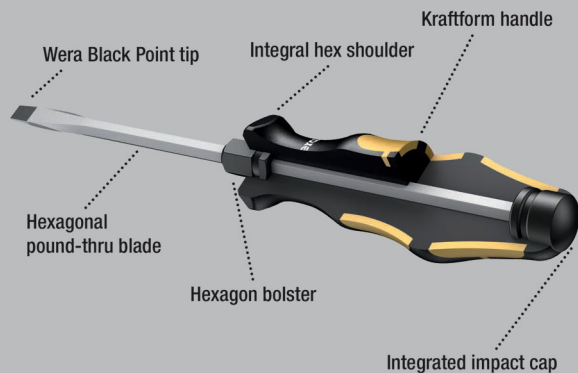

Wera Chiseldriver for fastening, chiselling and loosening seized screws. Multi-component Kraftform handle for fast and low-fatigue working. Kraftform Plus: hard gripping zones for high working speeds whereas soft zones ensure high torque transfer. A hexagon blade out of high quality bit material that extends right through the blade ensures full transfer of force, even when struck with a hammer.

The ductile tempered material prevents the blade from splintering or breaking. Comes with an impact cap for durability and reduced risk of splintering. More torque can be transferred with the help of an open-end or ring spanner applied to the integrated hexagonal bolster.

The Wera Black Point tip and a complex hardening process ensure a long service life of the tip, enhanced corrosion protection and an exact fit. The hexagonal anti-roll feature prevents any bothersome rolling away at the workplace.

### 932 A Screwdriver for slotted screws



	EAN	⊖	⊖	⬡	⊕	⊖	⊖	⊕
Code	4013288	mm	mm	mm	mm	mm	mm	
05018260001 <sup>1)</sup>	018007	0,6	3,5	4		80	81	10
05018262001	018014	0,8	4,5	5	8	90	98	10
05018264001	018021	1,0	5,5	6	10	100	105	10
05018266001	018038	1,2	7,0	6	10	125	105	10
05018268001	018045	1,6	9,0	8	13	150	112	10
05018270001	018052	1,6	10,0	8	13	175	112	5
05018272001 <sup>2)</sup>	018069	2,0	12,0	10	16	200	117	2
05018274001 <sup>2)</sup>	018076	2,5	14,0	10	16	250	117	2

<sup>1)</sup> No throughout blade, no impact cap and no hexagon bolster

<sup>2)</sup> Kraftform with non-roll feature, single-component

### 932 A SB Screwdriver for slotted screws



Code	EAN			
05100085001	181596	⊖	932 A 1x 1.0x5.5x100	10
05100086001	181602	⊖	932 A 1x 1.2x7.0x125	10
05100087001	181619	⊖	932 A 1x 1.6x9.0x150	10

### 932 AS Screwdriver for slotted screws

- Hexagonal blade extending through the handle, impact cap with integrated square and bolster

### 932 AS Screwdriver for slotted screws



	EAN	⊖	⊖	⬡	⊕	⊖	⊖	⊕
Code	4013288	mm	mm	mm	mm	mm	mm	
05018300001	134486	0,8	4,5	5	8	100	98	10
05018301001	134462	1,0	5,5	6	10	113	105	10
05018302001	134455	1,2	7,0	6	10	138	105	10



### 917 SPH Screwdriver for Phillips screws



	EAN	+	mm	mm	mm	mm	mm	mm	
Code	4013288								
05017005001	017734	PH 1	5	8	80	98	3 1/8"	10	
05017010001	017741	PH 2	6	10	100	105	4"	10	
05017015001	017758	PH 3	8	13	150	112	6"	5	
05017020001	017765	PH 4	10	16	200	117	8"	2	

### 917 SPH SB Screwdriver for Phillips screws



Code	EAN	+		
05100075001	181565	+	917 SPH 1x PH 1x80	10
05100076001	181572	+	917 SPH 1x PH 2x100	10
05100077001	181589	+	917 SPH 1x PH 3x150	5

### 917 SPHS Screwdriver for Phillips screws

- Hexagonal blade extending through the handle, impact cap with integrated square and bolster

### 917 SPHS Screwdriver for Phillips screws



	EAN	+	mm	mm	mm	mm	mm	mm	
Code	4013288								
05017040001	134493	PH 1	5	8	90	98	3 35/64"	10	
05017041001	134448	PH 2	6	10	113	105	4 29/64"	10	

### 918 SPZ Screwdriver for Pozidriv screws



	EAN	*	mm	mm	mm	mm	mm	mm	
Code	4013288								
05017050001	017772	PZ 1	5	8	80	98	3 1/8"	10	
05017052001	017789	PZ 2	6	10	100	105	4"	10	
05017054001	017796	PZ 3	8	13	150	112	6"	5	
05017056001	017802	PZ 4	10	16	200	117	8"	2	

### 918 SPZ SB Screwdriver for Pozidriv screws



Code	EAN	*		
05100080001	181633	+	918 SPZ 1x PZ 1x80	10
05100081001	181640	+	918 SPZ 1x PZ 2x100	10
05100082001	181657	+	918 SPZ 1x PZ 3x150	5

### 977 Screwdriver for TORX® screws



	EAN	*	mm	mm	mm	mm	mm	mm	
Code	4013288								
05024400001	094742	TX 15	5	8	80	98	3 1/8"	10	
05024401001	094759	TX 20	5	8	90	98	3 1/2"	10	
05024402001	094766	TX 25	6	10	100	105	4"	10	
05024403001	094773	TX 27	6	10	125	105	5"	10	
05024404001	094780	TX 30	8	13	150	112	6"	10	
05024405001	094797	TX 40	8	13	150	112	6"	10	

### Big Pack 900 Screwdriver set Kraftform Wera: Chiseldriver and rack

- Storage rack for wall-mounting

#### Big Pack 900 Screwdriver set Kraftform Wera: Chiseldriver and rack



Code	EAN		
05133285001	4013288 176349		1
		+	<b>917 SPH</b> 1x PH 1x80; 1x PH 2x100; 1x PH 3x150
		+	<b>918 SPZ</b> 1x PZ 1x80; 1x PZ 2x100; 1x PZ 3x150
		-	<b>932 A</b> 1x 0,6x3,5x80 <sup>1)</sup> ; 1x 0,8x4,5x90; 1x 1,0x5,5x100; 1x 1,2x7,0x125; 1x 1,6x9,0x150
		*	<b>977 TORX®</b> 1x TX 20x90; 1x TX 25x100
			<b>Rack</b> 2x 190,0x50,0

<sup>1)</sup>No throughout blade, no impact cap and no hexagon bolster

### 932/6 Screwdriver set Kraftform Wera: Chiseldriver and rack

- Storage rack for wall-mounting

#### 932/6 Screwdriver set Kraftform Wera: Chiseldriver and rack

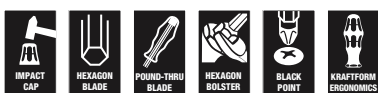

Code	EAN		
05018282001	4013288 018090		1
		+	<b>917 SPH</b> 1x PH 1x80; 1x PH 2x100
		-	<b>932 A</b> 1x 0,6x3,5x80 <sup>1)</sup> ; 1x 0,8x4,5x90; 1x 1,0x5,5x100; 1x 1,2x7,0x125

<sup>1)</sup>No throughout blade, no impact cap and no hexagon bolster

### 932 S/6 Screwdriver set Kraftform Wera: Chiseldriver and rack

- Impact cap with integrated square and bolster for the transfer of higher torque
- Storage rack for wall-mounting

#### 932 S/6 Screwdriver set Kraftform Wera: Chiseldriver and rack



Code	EAN		
05018283001	4013288 134479		1
		+	<b>917 SPHS</b> 1x PH 1x90; 1x PH 2x113
		-	<b>932 A</b> 1x 0,6x3,5x80 <sup>1)</sup>
		-	<b>932 AS</b> 1x 0,8x4,5x100; 1x 1,0x5,5x113; 1x 1,2x7,0x138

<sup>1)</sup>No throughout blade, no impact cap and no hexagon bolster

### 932/918/6 Screwdriver set Kraftform Wera: Chiseldriver and rack

- Storage rack for wall-mounting

#### 932/918/6 Screwdriver set Kraftform Wera: Chiseldriver and rack



Code	EAN		
05018287001	4013288 018137		1
		+	<b>918 SPZ</b> 1x PZ 1x80; 1x PZ 2x100
		-	<b>932 A</b> 1x 0,6x3,5x80 <sup>1)</sup> ; 1x 0,8x4,5x90; 1x 1,0x5,5x100; 1x 1,2x7,0x125

<sup>1)</sup>No throughout blade, no impact cap and no hexagon bolster

**977/6 TORX® Screwdriver set Kraftform Wera:**  
Chiseldriver and rack

- Storage rack for wall-mounting

**977/6 TORX® Screwdriver set Kraftform Wera: Chiseldriver and rack**



Code	EAN			
05024410001	4013288	094803		1
			977 TORX®	
			1x TX 15x80; 1x TX 20x90; 1x TX 25x100; 1x TX 27x125; 1x TX 30x150; 1x TX 40x150	

**Kraftform - the shape that adapts to the hand**

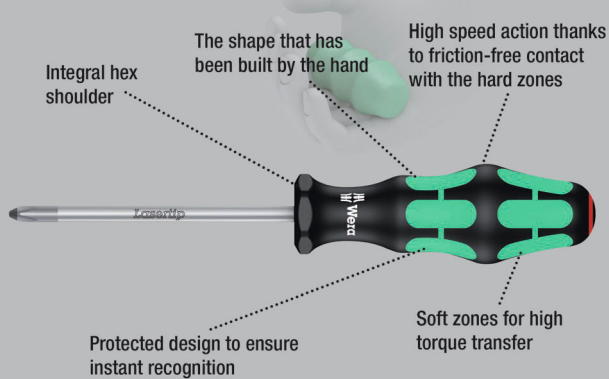

High quality Kraftform Plus screwdriver with electrician's blade. Multi-component Kraftform Plus handle for pleasant, ergonomic working that makes blisters and calluses a thing of the past. Hard gripping zones for high working speeds whereas soft zones ensure high torque transfer.

The tips of Wera Lasertip screwdrivers are microscopically roughened by means of laser beams. This rough surface literally bites into the head of the screw. Any unintentional slipping out is therefore prevented.

Take it easy tool finder with colour coding according to profiles and size stamp – for simple and rapid accessing of the required tool. The hexagonal anti-roll feature prevents any bothersome rolling away at the workplace and handle markings make for simplified finding and sorting of the tool.

- Smooth hard zones for high speed turning, soft grip zones for high torque transfer
- Take it easy tool finder: colour coding according to profile and size
- Hexagonal anti-roll feature against rolling away
- Lasertip tips for more secure fit in the screw head

**Lasertip - laser engineered blade**

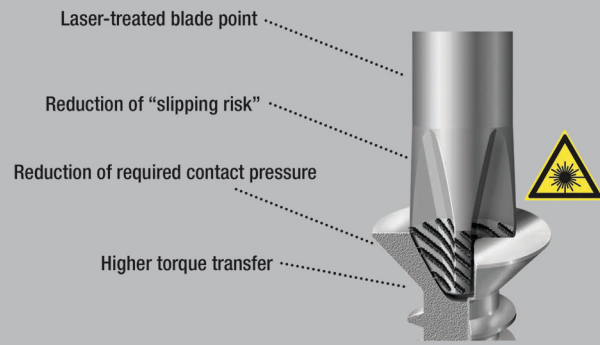

**335 Screwdriver for slotted screws**



	EAN	mm	mm	mm	mm	mm		
Code	4013288							
05008006001 <sup>1)</sup>	039996	0,4	2,0	60	70	2,5	5/64"	10
05110000001 <sup>1)</sup>	003232	0,4	2,5	60	70	2,5	3/32"	10
05008007001 <sup>1)</sup>	003249	0,4	2,5	75	70	2,5	3/32"	10
05110001001 <sup>1)</sup>	003256	0,5	3,0	80	81	3,0	1/8"	10
05008008001 <sup>1)</sup>	107985	0,5	3,0	150	81	4,0	1/8"	10
05008009001 <sup>1)</sup>	107992	0,5	3,0	200	81	4,0	1/8"	5
05008015001 <sup>1)</sup>	003263	0,6	3,5	100	81	3,5	9/64"	10
05110002001 <sup>1)</sup>	003270	0,6	3,5	125	81	3,5	9/64"	10
05110003001 <sup>1)</sup>	003287	0,6	3,5	200	81	3,5	9/64"	5
05110004001	003294	0,8	4,0	100	98	4,0	5/32"	10
05110005001	003300	0,8	4,0	150	98	4,0	5/32"	10
05110006001	003317	0,8	4,0	200	98	4,0	5/32"	5
05008027001 <sup>1)</sup>	003324	0,8	4,0	300	98	4,0	5/32"	2
05110007001	003331	1,0	5,5	125	98	5,5	7/32"	10
05008055001	003348	1,0	5,5	150	98	5,5	7/32"	10
05110008001	003355	1,0	5,5	200	98	5,5	7/32"	5
05008060001 <sup>1)</sup>	003362	1,0	5,5	300	98	5,5	7/32"	2
05008061001	108005	1,2	6,0	100	105	6,0	15/64"	10

<sup>1)</sup> without Lasertip

### 335 SB Slotted screwdriver



Code	EAN			
	4013288			
05100042001	181275		<b>335</b> 1x 0.6x3.5x100 <sup>1)</sup>	10
05100043001	181251		<b>335</b> 1x 0.8x4.0x100	10
05100044001	181244		<b>335</b> 1x 1.0x5.5x125	10

### 334 SK Screwdriver for slotted screws

- Hexagonal blade and bolster for higher torque transfer

### 334 SK Screwdriver for slotted screws



Code	EAN							
	4013288	mm	mm	mm	mm	mm	mm	
05007670001 <sup>1)</sup>	108036	0,6	3,5	4	-	75	81	10
05007671001	108043	0,8	4,0	4	-	90	81	10
05007672001	108050	0,8	4,5	5	8	90	98	10
05007673001	108067	1,0	5,5	6	10	100	98	10
05007674001	108074	1,2	6,5	6	10	125	105	10
05007675001	108081	1,2	7,0	6	10	125	105	10
05007676001	108098	1,6	9,0	8	13	150	112	10
05007677001	108104	1,6	10,0	8	13	175	112	5

<sup>1)</sup>without Lasertip

### 334 Screwdriver for slotted screws



	EAN							
<b>Code</b>	4013288	mm	mm	mm	mm	mm	mm	
05007610001	003058	0,8	5,0	100	98	5,0	3/16"	10
05007620001	003065	1,0	6,0	125	105	6,0	1/4"	10
05340330001	102553	1,0	6,0	150	105	6,0	1/4"	10
05110010001	003089	1,2	6,5	150	105	6,0	1/4"	10
05007635001	003072	1,2	7,0	150	105	7,0	9/32"	10
05007621001	108012	1,2	6,5	200	105	7,0	1/4"	5
05110011001	003096	1,2	8,0	175	112	7,0	5/16"	5
05007640001	108029	1,6	8,0	175	112	7,0	5/16"	5
05110104001	003102	1,6	10,0	200	112	9,0	3/8"	5
05110105001 <sup>1)</sup>	003119	2,0	12,0	250	117	10,0	1/2"	2

<sup>1)</sup>without Lasertip

### 334 SB Screwdriver for slotted screws



Code	EAN			
	4013288			
05100030001	181411		<b>334</b> 1x 1.2x6.5x150	10
05100031001	181220		<b>334</b> 1x 1.2x8.0x175	5

### 350 SK PH Screwdriver for Phillips screws

- Hexagonal blade and bolster for higher torque transfer

#### 350 SK PH Screwdriver for Phillips screws



	EAN	+	mm	mm	mm	mm	mm	mm	mm
Code	4013288								
05008750001 <sup>1)</sup>	108128	PH 0	4		60	81	2 3/8"		5
05008751001	108135	PH 1	5	8	80	98	3 1/8"		10
05008752001	108142	PH 2	6	10	100	105	4"		10
05008753001	108159	PH 3	8	13	150	112	6"		5

<sup>1)</sup>without Lasertip

#### 350 PH Screwdriver for Phillips screws



	EAN	+	mm	mm	mm	mm	mm	mm	mm
Code	4013288								
05008705001 <sup>1)</sup>	003591	PH 0	60	81	3,0	2 3/8"			5
05008706001 <sup>1)</sup>	108111	PH 0	100	81	3,0	4"			5
05008710001	003607	PH 1	80	98	4,5	3 1/8"			10
05008712001	003614	PH 1	200	98	4,5	8"			2
05008715001 <sup>1)</sup>	003621	PH 1	300	98	4,5	12"			2
05008720001	003638	PH 2	100	105	6,0	4"			10
05008723001	097996	PH 2	150	105	6,0	6"			10
05008725001	003645	PH 2	200	105	6,0	8"			2
05008730001 <sup>1)</sup>	003652	PH 2	300	105	6,0	12"			2
05008735001	003669	PH 3	150	112	8,0	6"			5
05008740001 <sup>1)</sup>	003676	PH 4	200	112	10,0	8"			2

<sup>1)</sup>without Lasertip

### 350 PH SB Screwdriver for Phillips screws



	EAN	+	mm	mm	mm	mm	mm	mm	mm
Code	4013288								
05100050001	181329	+	350 PH						10
			1x PH 0x60 <sup>1)</sup>						
05100051001	181336	+	350 PH						10
			1x PH 1x80						
05100052001	181343	+	350 PH						10
			1x PH 2x100						

<sup>1)</sup>without Lasertip

### 355 SK PZ Screwdriver for Pozidriv screws

- Hexagonal blade and bolster for higher torque transfer

#### 355 SK PZ Screwdriver for Pozidriv screws



	EAN	+	mm	mm	mm	mm	mm	mm	mm
Code	4013288								
05009340001 <sup>1)</sup>	108180	PZ 0	4		60	81	2 3/8"		5
05009341001	108197	PZ 1	5	8	80	98	3 1/8"		10
05009342001	108203	PZ 2	6	10	100	105	4"		10
05009343001	108210	PZ 3	8	13	150	112	6"		5

<sup>1)</sup>without Lasertip

### 355 PZ Screwdriver for Pozidriv screws



Code	EAN	+	mm	mm	mm	mm	
05009305001 <sup>1)</sup>	004024	PZ 0	60	81	3,0	2 3/8"	10
05009310001	004031	PZ 1	80	98	4,5	3 1/8"	10
05009312001	004048	PZ 1	200	98	4,5	8"	2
05009313001 <sup>1)</sup>	108166	PZ 1	300	98	4,5	12"	2
05009315001	004055	PZ 2	100	105	6,0	4"	10
05009317001	004062	PZ 2	200	105	6,0	8"	2
05347743001	097040	PZ 2	250	105	6,0	10"	2
05009319001 <sup>1)</sup>	108173	PZ 2	300	105	6,0	12"	2
05009320001	004079	PZ 3	150	112	8,0	6"	5
05009325001 <sup>1)</sup>	004086	PZ 4	200	112	10,0	8"	2

<sup>1)</sup>without Lasertip

### 355 PZ SB Screwdriver for Pozidriv screws



Code	EAN	+		
05100055001	181282	+	355 PZ 1x PZ 0x60 <sup>1)</sup>	10
05100056001	181299	+	355 PZ 1x PZ 1x80	10
05100057001	181305	+	355 PZ 1x PZ 2x100	10

<sup>1)</sup>without Lasertip

### Hex-Plus - lets hexagon socket screws last longer

Deformation of the screws is reduced

Above-average service life

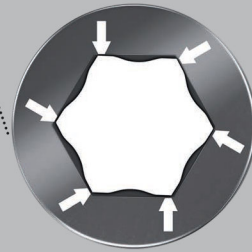

High quality Kraftform Plus screwdriver.

Multi-component Kraftform handle for fast and low-fatigue working. Kraftform Plus: hard gripping zones for high working speeds whereas soft zones ensure high torque transfer.

Hex-Plus offers a larger contact surface within the screw head. This reduces the notching effects to a minimum and almost completely eliminates the risk of destroying the screw recess.

Take it easy Tool Finder: colour coding according to profile and size. The hexagonal anti-roll feature prevents any bothersome rolling away at the workplace.

- Hexagonal screwdriver Hex-Plus
- Hex-Plus allows socket head screws to live longer

### 354 Screwdriver for hexagon socket screws



Code	EAN	mm	mm	mm	mm	mm	
05023105001	003942	2,0	75	70	3,0	3"	5
05023107001	003959	2,5	75	81	3,0	3"	10
05023110001	003966	3,0	75	81	4,0	3"	10
05023115001	003973	4,0	75	98	5,0	3"	10
05023120001	003980	5,0	80	105	6,0	3 1/8"	10
05023125001	003997	6,0	80	105	7,0	3 1/8"	5
05023130001	004000	8,0	100	112	10,0	4"	5

### 352 Ball end screwdriver for hexagon socket screws

- Hexagonal blade and ballpoint for secure working even in difficult installation situations

#### 352 Ball end screwdriver for hexagon socket screws



	EAN	⬡	⬡	⬆	⬆	⬆		
Code	4013288	mm	mm	mm	mm	mm		
05022795001	032577	1,5		60	70	2 3/8"		10
05022800001	003751	2,0		100	70	4"		10
05138070001	003768	2,5		100	81	4"		10
05022805001	003775	3,0		100	81	4"		10
05022810001	003782	4,0		100	98	4"		10
05022815001	003799	5,0		100	105	4"		10
05022820001	003805	6,0		125	105	5"		5
05022825001	003812	8,0		150	112	6"		5
05022830001	003829	10,0		150	112	6"		5
05022835001	003836	12,0		150	117	6"		5
05022905001	003843		5/32"	100	98	4"		5
05022910001	003850		3/16"	100	105	4"		5
05022920001	003874		1/4"	125	105	5"		5

### TORX® Tools with holding function

Clamping force holds TORX® screw tight.

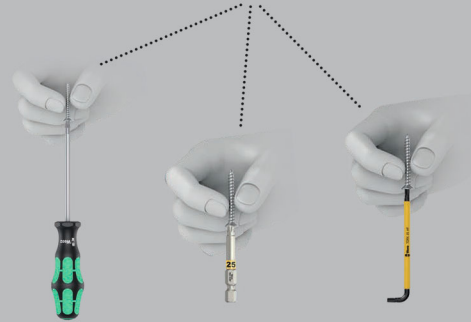

High quality Kraftform Plus screwdriver.

Multi-component Kraftform handle for fast and low-fatigue working. Kraftform Plus: hard gripping zones for high working speeds whereas soft zones ensure high torque transfer.

Holding function: the wedging forces resulting from the contact pressure between the drive tip and the screw profile securely hold the screw on the tool.

The hexagonal anti-roll feature prevents any bothersome rolling away at the workplace. Handle markings for simplified finding and sorting of the tool.

- Screwdriver for recessed TORX® screws
- Holding function for TORX® screws
- Multi-component Kraftform handle for fast and ergonomic screwdriving
- Handle markings simplify finding and sorting of tools
- Hexagonal anti-roll feature against rolling away

### 367 TORX® HF Screwdriver with holding function for TORX® screws



	EAN	⬡	⬆	⬆	⊘	⬆		
Code	4013288		mm	mm	mm	mm		
05028048001	106643	TX 8	60	81	3,5	2 3/8"		10
05028049001	106650	TX 9	60	81	4,0	2 3/8"		10
05028050001	100696	TX 10	80	81	4,0	3 1/8"		10
05028051001	100702	TX 15	80	98	4,0	3 1/8"		10
05028052001	100719	TX 20	100	98	4,5	4"		10
05028070001	138415	TX 20	300	98	4,5	12"		4
05028053001	100726	TX 25	100	105	5,0	4"		10
05028071001	138408	TX 25	300	105	6,0	12"		4
05028054001	100733	TX 27	115	105	5,5	4 9/16"		10
05028072001	138392	TX 27	300	105	6,0	12"		4
05028055001	100740	TX 30	115	105	6,0	4 9/16"		10
05028073001	138385	TX 30	300	105	6,0	12"		4
05028056001	100757	TX 40	130	112	7,0	5 3/16"		10

### 367 Screwdriver for TORX® screws



	EAN						
Code	4013288		mm	mm	mm	"	
05028000001	025852	TX 5	60	70	3,5	2 3/8"	10
05028001001	004185	TX 6	60	70	3,5	2 3/8"	10
05028002001	004192	TX 7	60	70	3,5	2 3/8"	10
05028003001	004208	TX 8	60	81	3,5	2 3/8"	10
05028004001	004215	TX 9	60	81	4,0	2 3/8"	10
05028005001	004222	TX 10	80	81	4,0	3 1/8"	10
05028008001	004239	TX 15	80	98	4,0	3 1/8"	10
05028010001	004246	TX 20	100	98	4,5	4"	10
05028012001	004253	TX 25	100	105	5,0	4"	10
05028013001	004260	TX 27	115	105	5,5	4 9/16"	10
05028015001	004277	TX 30	115	105	6,0	4 9/16"	10
05028020001	004284	TX 40	130	112	7,0	5 1/8"	10

### 367 SB Screwdriver for TORX® screws



Code	EAN			
	4013288			
05100060001	181350		<b>367 TORX®</b> 1x TX 10x80	10
05100061001	181367		<b>367 TORX®</b> 1x TX 15x80	10
05100062001	181374		<b>367 TORX®</b> 1x TX 20x100	10
05100063001	181381		<b>367 TORX®</b> 1x TX 25x100	10
05100064001	181398		<b>367 TORX®</b> 1x TX 30x115	10

### 367 TORX® B0 Screwdriver for tamper-proof TORX® screws

High quality Kraftform Plus screwdriver. Multi-component Kraftform handle for fast and low-fatigue working.

TORX® B0 screws have a protruding pin in their drive profile. This prevents any unauthorised loosening since the "normal" hex tools cannot move these screws. Only special TORX® B0 tools have a bore hole which can slip over the pin.

The Wera Black Point tip and a complex hardening process ensure a long service life of the tip, enhanced corrosion protection and an exact fit.

The hexagonal anti-roll feature prevents any bothersome rolling away at the workplace. Handle markings for simplified finding and sorting of the tool.

- Screwdrivers for recessed TORX® screws with safety pin

### 367 TORX® B0 Screwdriver for tamper-proof TORX® screws



	EAN						
Code	4013288		mm	mm	mm	"	
05138257001	039965	TX 7	60	70	3,5	2 3/8"	5
05138258001	039972	TX 8	60	81	3,5	2 3/8"	5
05138259001	039989	TX 9	60	81	4,0	2 3/8"	5
05138260001	025869	TX 10	80	81	4,0	3 1/8"	5
05138268001	108234	TX 10	300	81	4,0	12"	5
05138261001	025876	TX 15	80	98	4,0	3 1/8"	5
05138269001	108241	TX 15	300	98	4,0	12"	2
05138262001	025883	TX 20	100	98	4,5	4"	5
05138270001	108258	TX 20	300	98	4,5	12"	2
05138263001	025890	TX 25	100	105	5,0	4"	5
05138264001	025906	TX 27	115	105	5,5	4 9/16"	5
05138265001	025913	TX 30	115	105	6,0	4 9/16"	5
05138266001	025920	TX 40	130	112	7,0	5 1/8"	5



### 367 TORX PLUS® Screwdriver for TORX PLUS® screws

High quality Kraftform Plus screwdriver by Wera. TORX PLUS® profile: in comparison to "normal" TORX® profiles, the enlargement of the 6 torque-transferring flanks between the tool and screw is implemented by using an elliptical and not circular profile design.

This means that the power applied when fastening is spread across a larger surface area. Higher torque is transferred and the service life of the screw and tool is also enhanced. Multi-component Kraftform handle for rapid and convenient working.

Kraftform Plus: hard gripping zones for high working speeds whereas soft zones ensure high torque transfer. The Wera Black Point tip offers a perfect fit and optimised corrosion protection. The hexagonal non-roll feature prevents any annoying rolling away at the workplace. Handle markings for simplified finding and sorting of the tools.

### 367 TORX PLUS® Screwdriver for TORX PLUS® screws



Code	EAN		mm	mm	mm	mm	
05028029001	041555	5 IP	60	70	3,5	2 3/8"	5
05028030001	040091	6 IP	60	70	3,5	2 3/8"	5
05028031001	040107	7 IP	60	70	3,5	2 3/8"	5
05028032001	040114	8 IP	60	70	3,5	2 3/8"	5
05028033001	040121	9 IP	60	81	4,0	2 3/8"	5
05028034001	040138	10 IP	80	81	4,0	3 1/8"	5
05028035001	040145	15 IP	80	98	4,0	3 1/8"	5
05028036001	040152	20 IP	100	98	4,5	4"	5
05028037001	040169	25 IP	100	105	5,0	4"	5
05028038001	040176	30 IP	115	105	6,0	4 9/16"	5

### 368 Screwdriver for square socket head screws

High quality Kraftform Plus screwdriver for square socket screws. The colour coding system allows the user to quickly find and identify the size needed. Multi-component Kraftform handle for fast and low-fatigue working.

The Wera Black Point tip offers optimised corrosion protection and an exact fit. The hexagonal anti-roll feature prevents any bothersome rolling away at the workplace. Handle markings for simplified finding and sorting of the tool.

### 368 Screwdriver for square socket head screws



Code	EAN		mm	mm	mm	mm	
05117680001	028723	# 00	60	81	3,5	2 3/8"	5
05117681001	028730	# 0	60	81	4,0	2 3/8"	5
05117682001	028747	# 1	80	98	4,5	3 1/8"	5
05117683001	028754	# 1	200	98	4,5	8"	5
05117684001	028761	# 2	100	105	6,0	4"	5
05117685001	028778	# 2	200	105	6,0	8"	5
05117691001	040916	# 2	300	105	6,0	12"	2
05117686001	028785	# 3	150	112	8,0	6"	5
05117687001	028792	# 4	200	112	8,0	8"	5

### 368 SB Screwdriver for square socket head screws



Code	EAN			
05100070001	181404	368	1x # 1x80	5
05100071001	181428	368	1x # 2x100	5
05100072001	181435	368	1x # 3x150	5

### 338 Actuation tool for terminal blocks (spring cages)

- Special tool for unlocking contact springs in electrotechnical line terminals
- Due to the curved geometry, even terminal blocks that cannot be reached with normal screwdrivers can be operated
- Suitable for spring terminals with a conductor cross-section of up to 1.5 mm<sup>2</sup> and 2.5 to 4.0 mm<sup>2</sup>

#### 338 Actuation tool for terminal blocks (spring cages)



	EAN							
Code	4013288	mm	mm	mm	mm	mm		
05008101001	225641	0,4	2,5	81	81	2,5	3/32"	10
05008102001	225788	0,6	3,5	81	81	3,5	9/64"	10

### 391 Hose clamp screwdriver

- Hose clamp screwdriver for hexagon head screws
- Flexible, circular blade

#### 391 Hose clamp screwdriver



	EAN							
Code	4013288	mm	mm	mm	mm			
05028148001	004703	6	167	98	6 9/16"			5
05028150001	004710	7	167	98	6 9/16"			5
05028152001	004727	8	167	98	6 9/16"			5

### 395 Nutdriver

- Nutsetter for hexagon head screws

#### 395 Nutdriver



	EAN							
Code	4013288	mm	mm	mm	mm	mm		
05028205001	004734	3,0	125	98	5,0	5"		5
05028210001	004741	3,5	125	98	6,1	5"		5
05028215001	004758	4,0	125	98	6,9	5"		5
05028220001	004765	4,5	125	98	7,1	5"		5
05028225001	004772	5,0	125	98	8,1	5"		5
05028230001	004789	5,5	125	98	8,1	5"		5
05029405001	004796	6,0	125	98	9,1	5"		5
05029410001	004802	7,0	125	105	11,0	5"		5
05029415001	004819	8,0	125	105	12,1	5"		5
05029420001	004826	9,0	125	105	13,1	5"		5
05029425001	004833	10,0	125	112	14,1	5"		5
05029430001	004840	11,0	125	112	16,0	5"		5
05029435001	004857	12,0	125	112	17,1	5"		5
05029440001	004864	13,0	125	112	18,1	5"		5
05029445001	004871	14,0	125	112	19,1	5"		5
05029450001	004888	15,0	125	112	21,0	5"		5

### 395 HO Nutdriver

High quality nutsetter with hollow shaft by Wera. Hollow shaft for the fastening of threaded rods; only then can the threaded rod with nut slip into the hollow shaft. Multi-component Kraftform handle for high working speeds and particularly ergonomic screwdriving.

Kraftform Plus: hard gripping zones for high working speeds whereas soft zones ensure high torque transfer. Hexagonal anti-roll feature prevents any rolling away and handle markings make for simplified finding and sorting of the tool; for hexagon head screws.

- Nutsetter for hexagon head screws
- Hollow shaft for protruding threaded rods, chrome-plated

### 395 HO Nutdriver



	EAN							
Code	4013288	mm	mm	mm	mm	mm	mm	
05029460001	108296	5,0	90	98	7,2	3 35/64"	5	
05029461001	108302	5,5	90	98	7,2	3 35/64"	5	
05029462001	108319	6,0	90	98	7,2	3 35/64"	5	
05029463001	108326	7,0	90	105	7,2	3 35/64"	5	
05029464001	108333	8,0	90	105	9,3	3 35/64"	5	
05029465001	108340	10,0	90	112	9,3	3 35/64"	5	
05029466001	108357	13,0	90	112	11,0	3 35/64"	5	
05029501001	110503		90	98	7,2	3 35/64"	5	
05029502001	110510		90	98	7,2	3 35/64"	5	
05029503001	110527		90	105	9,3	3 35/64"	5	
05029504001	110534		90	105	9,3	3 35/64"	5	
05029505001	110541		90	112	9,3	3 35/64"	5	
05029506001	110558		90	112	11,0	3 35/64"	5	
05029507001	110565		90	112	11,0	3 35/64"	5	

### Take it easy tool finder with color markings - for quick tool identification

Bits: Take it easy tool finder .....

Zyklop sockets: Take it easy tool finder .....

L-Keys: Take it easy tool finder .....

Joker: Take it easy tool finder .....

Especially small screwdrivers with short blades for hard to reach areas. The 2-component Kraftform handle with its practical combination of hard and soft zones allows for a firm grip and precise working.

The blades have all the benefits of the Wera Bit technology. Special surface treatment of the blades for high corrosion protection and optimum fitting accuracy in the screw.

The hexagon anti-roll protection prevents annoying rolling away of bits in the workplace.

- Short compact shape for working in confined spaces
- Ergonomic 2-component Kraftform handle for precise work
- Blades with the benefits of the Wera Bit technology
- Hexagonal anti-roll feature against rolling away
- Take it easy tool finder: colour coding according to profile and size

### 335 Stubby/carburetor screwdriver



	EAN							
Code	4013288	mm	mm	mm	mm	mm	mm	
05008840001	212115	0,6	3,5	24,5	54	3,5	9/64"	5
05008841001	212122	0,8	4,0	24,5	54	4,0	5/32"	5
05008842001	212139	1,0	5,5	24,5	54	5,5	7/32"	5
05008843001	212146	1,2	6,5	24,5	54	6,5	1/4"	5
05008844001	212153	1,2	7,0	24,5	54	8,0	5/16"	5

### 350 PH Phillips-head Stubby/carburetor screwdriver



	EAN	+	□	⌀	□		
<b>Code</b>	4013288		mm	mm	mm	□	
05008850001	212160	PH 1	25	54	4,2	1"	5
05008851001	212177	PH 2	25	54	5,2	1"	5
05008852001	212184	PH 3	25	54	6,2	1"	5

### 355 PZ Phillips-head Stubby/carburetor screwdriver



	EAN	*	□	⌀	□		
<b>Code</b>	4013288		mm	mm	mm	□	
05008853001	212191	PZ 1	25	54	4,5	1"	5
05008854001	212207	PZ 2	25	54	6,0	1"	5
05008855001	212214	PZ 3	25	54	8,0	1"	5

### 367 TORX® Stubby screwdriver



	EAN	*	□	⌀	□		
<b>Code</b>	4013288		mm	mm	mm	□	
05008856001	212245	TX 10	25	54	3,4	1"	5
05008857001	212252	TX 15	25	54	3,7	1"	5
05008858001	212269	TX 20	25	54	4,0	1"	5
05008859001	212276	TX 25	25	54	4,5	1"	5
05008860001	212283	TX 27	25	54	5,1	1"	5
05008861001	212290	TX 30	25	54	5,6	1"	5
05008862001	212306	TX 40	25	54	-	1"	5

### 368 Stubby screwdriver for square head socket screws

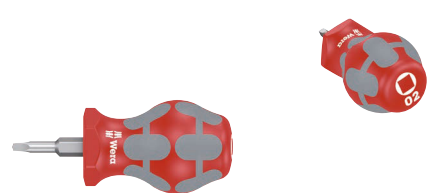

	EAN	□	□	⌀	□		
<b>Code</b>	4013288		mm	mm	mm	□	
05008863001	212313	# 01	25	54	4,2	1"	5
05008864001	212320	# 02	25	54	4,2	1"	5

### 9650 Magnetic rail Kraftform screwdriver set

Kraftform screwdriver set, 9-piece set, on a magnetic rail. Screwdriver all-round set. Kraftform Plus handle for comfortable ergonomic screwdriving, avoiding blisters and calluses. Hard handle zones for high working speeds, while soft handle zones guarantee a high torque transfer.

932 A with pound-thru hexagonal blade and impact cap; 350, 355 and 335 with Lasertip: The tips of Wera Lasertip screwdrivers are microscopically roughened with laser beams.

This rough surface "bites" into the screw head and unintentional slipping is a thing of the past. 160 is VDE-insulated and with Lasertip.

"Take it easy" Tool finder with colour coding by profile and size stamping - for quick and easy identification of the required tool. The clips hold the tools perfectly. With its strong magnet, the rail holds securely to metal surfaces. It can also be bolted to the wall.

- For every application the right tool
- The clips hold the tools perfectly
- With its strong magnet, the rail holds securely to metal surfaces. It can also be bolted to the wall

### 9650 Magnetic rail Kraftform screwdriver set



Code	EAN		
05051012001	228970		1
		<ul style="list-style-type: none"> <li>932 A 1x 1,0x5,5x100; 1x 1,2x7,0x125</li> <li>350 1x PH 2x100</li> <li>355 1x PZ 1x80; 1x PZ 2x100</li> <li>367 TORX® 1x TX 20x100; 1x TX 25x100</li> <li>335 1x 0,8x4,0x100</li> <li>160 is VDE 1x 0,6x3,5x100</li> <li>9611 1x 30,0x400,0</li> </ul>	

## Kraftform Big Pack 300

- Screwdrivers for slotted, cross-recess Phillips and Pozidriv screws and TORX®

### Kraftform Big Pack 300



Code	EAN		
05105630001	4013288 163622		1
		<b>+</b> 350 PH 1x PH 1x80; 1x PH 2x100; 1x PH 3x150	
		<b>+</b> 355 PZ 1x PZ 1x80; 1x PZ 2x100; 1x PZ 3x150	
		<b>*</b> 367 TORX® 1x TX 10x80; 1x TX 15x80; 1x TX 20x100; 1x TX 25x100; 1x TX 30x115	
		<b>—</b> 334 1x 1,2x6,5x150	
		<b>—</b> 335 1x 0,6x3,5x100 <sup>1)</sup> ; 1x 0,8x4,0x100	
		<b>Rack</b> 2x 190,0x50,0	

<sup>1)</sup> without Lasertip

## Kraftform XXL

- For every application the right tool

### Kraftform XXL



Code	EAN		
05051010001	4013288 139092		1
		<b>+</b> 350 PH 1x PH 1x80; 1x PH 2x100	
		<b>+</b> 355 PZ 1x PZ 1x80; 1x PZ 2x100	
		<b>—</b> 932 A 1x 1,0x5,5x100; 1x 1,2x7,0x125	
		<b>—</b> 334 1x 1,2x6,5x150	
		<b>—</b> 335 1x 0,8x4,0x100; 1x 1,0x5,5x125	
		<b>—</b> 160 i VDE 1x 0,4x2,5x80 <sup>1)</sup> ; 1x 0,6x3,5x100 <sup>1)</sup>	
		<b>—</b> 247 1x 0,5x3,0x70	
		<b>Rack</b> 2x 190,0x50,0	

<sup>1)</sup> without Lasertip

<sup>2)</sup> Product not available in the USA and Canada.

## Kraftform XXL 2



Code	EAN		
05051011001	4013288 144225		1
		+	<b>350 PH</b> 1x PH 2x100
		+	<b>355 PZ</b> 1x PZ 1x80; 1x PZ 2x100
		●	<b>932 A</b> 1x 1,0x5,5x100; 1x 1,2x7,0x125
		●	<b>335</b> 1x 0,8x4,0x100
		⊕	<b>367 TORX®</b> 1x TX 15x80; 1x TX 20x100; 1x TX 25x100
		●	<b>160 i VDE</b> 1x 0,4x2,5x80 <sup>1)</sup> ; 1x 0,6x3,5x100 <sup>1)</sup>
		●	<b>247</b> 1x 0,5x3,0x70
			<b>Rack</b> 2x 190,0x50,0

<sup>1)</sup> without Lasertip

<sup>2)</sup> Product not available in the USA and Canada.

## Kraftform XXL 3



Code	EAN		
05347106001	4013288 182388		1
		●	<b>932 A</b> 1x 1,0x5,5x100; 1x 1,2x7,0x125
		+	<b>350 PH</b> 1x PH 1x80; 1x PH 2x100
		●	<b>334</b> 1x 1,2x6,5x150
		●	<b>335</b> 1x 0,8x4,0x100; 1x 1,0x5,5x125
		○	<b>368</b> 1x # 1x80; 1x # 2x100
		●	<b>160 i VDE</b> 1x 0,4x2,5x80 <sup>1)</sup> ; 1x 0,6x3,5x100 <sup>1)</sup>
			<b>Rack</b> 2x 190,0x50,0

<sup>1)</sup> without Lasertip

## Kraftform 2go 300

11 Kraftform screwdrivers; with Take it easy Toolfinder; in the Wera 2go 4 quiver; comes with an adjustable partition element for individual sectioning.

- Suitable for docking with the Wera 2go system

## Kraftform 2go 300



Code	EAN		
05004313001	4013288 187833		1
			<b>Wera 2go 4</b> 1x 165,0x165,0x105,0
		+	<b>350 PH</b> 1x PH 1x80; 1x PH 2x100
		+	<b>355 PZ</b> 1x PZ 1x80; 1x PZ 2x100
		⊕	<b>367 TORX®</b> 1x TX 10x80; 1x TX 15x80; 1x TX 20x100; 1x TX 25x100; 1x TX 30x115
		●	<b>334 SK</b> 1x 0,8x4,5x90; 1x 1,2x7,0x125
			<b>K120</b> 1x 50,0x120,0

## 334 SK/6 Rack Screwdriver set Kraftform Plus Lasertip and rack

- Hexagonal blade and bolster for higher torque transfer

## 334 SK/6 Rack Screwdriver set Kraftform Plus Lasertip and rack



Code	EAN		
05007680001	4013288 111418		1
		+	<b>350 SK PH</b> 1x PH 1x80; 1x PH 2x100
		●	<b>334 SK</b> 1x 0,6x3,5x75 <sup>1)</sup> ; 1x 0,8x4,0x90; 1x 1,0x5,5x100; 1x 1,2x6,5x125

<sup>1)</sup> without Lasertip

### 334/6 Rack Screwdriver set Krafftform Plus Lasertip and rack



Code	EAN		
05105650001	4013288 003133		1
		+	<b>350 PH</b> 1x PH 1x80; 1x PH 2x100
		-	<b>334</b> 1x 1,2x6,5x150
		-	<b>335</b> 1x 0,5x3,0x80 <sup>1)</sup> ; 1x 0,8x4,0x100; 1x 1,0x5,5x125

<sup>1)</sup>without Lasertip

### 334/355 SK/6 Screwdriver set Krafftform Plus Lasertip and rack

- Hexagonal blade and bolster for higher torque transfer

### 334/355 SK/6 Screwdriver set Krafftform Plus Lasertip and rack



Code	EAN		
05007681001	4013288 111425		1
		+	<b>355 SK PZ</b> 1x PZ 1x80; 1x PZ 2x100
		-	<b>334 SK</b> 1x 0,6x3,5x75 <sup>1)</sup> ; 1x 0,8x4,0x90; 1x 1,0x5,5x100; 1x 1,2x6,5x125

<sup>1)</sup>without Lasertip

### 334/355/6 Rack Screwdriver set Krafftform Plus Lasertip and rack



Code	EAN		
05105656001	4013288 003140		1
		+	<b>355 PZ</b> 1x PZ 1x80; 1x PZ 2x100
		-	<b>334</b> 1x 1,2x6,5x150
		-	<b>335</b> 1x 0,5x3,0x80 <sup>1)</sup> ; 1x 0,8x4,0x100; 1x 1,0x5,5x125

<sup>1)</sup>without Lasertip

### 335/350/355/6 Screwdriver set Krafftform Plus Lasertip and rack



Code	EAN		
05105622001	4013288 041616		1
		+	<b>350 PH</b> 1x PH 1x80; 1x PH 2x100
		+	<b>355 PZ</b> 1x PZ 1x80; 1x PZ 2x100
		-	<b>335</b> 1x 0,8x4,0x100; 1x 1,0x5,5x125

### 335/350/355/3 Screwdriver set Kraffform Plus 300 mm-long blades

- Extra-long blade for low-lying working situations

### 335/350/355/3 Screwdriver set Kraffform Plus 300 mm-long blades

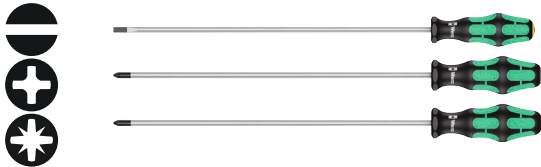

Code	EAN		
05347735002	120991		1
		335 1x 1,0x5,5x300 <sup>1)</sup>	
		350 PH 1x PH 2x300 <sup>1)</sup>	
		355 PZ 1x PZ 2x300 <sup>1)</sup>	

<sup>1)</sup>without Lasertip

### 335/350/355/4 Screwdriver set Kraffform Plus Lasertip 200 mm-long blades

- Extra-long blade for low-lying working situations

### 335/350/355/4 Screwdriver set Kraffform Plus Lasertip 200 mm-long blades



Code	EAN		
05347736002	117397		1
		350 PH 1x PH 2x200	
		355 PZ 1x PZ 1x200; 1x PZ 2x200	
		335 1x 1,0x5,5x200	

### 335/350/367/7 Rack Screwdriver set Kraffform Plus Lasertip and rack



Code	EAN		
05320540001	094704		1
		350 PH 1x PH 2x100	
		355 PZ 1x PZ 1x80; 1x PZ 2x100	
		335 1x 0,8x4,0x100	
		367 TORX® 1x TX 15x80; 1x TX 20x100; 1x TX 25x100	

### 367/7 TORX® HF Kraffform Plus Screwdriver set with holding function and rack

- Holding function for TORX® screws, chrome-plated

### 367/7 TORX® HF Kraffform Plus Screwdriver set with holding function and rack



Code	EAN		
05223161001	118226		1
		367 TORX® HF 1x TX 8x60; 1x TX 10x80; 1x TX 15x80; 1x TX 20x100; 1x TX 25x100; 1x TX 27x115; 1x TX 30x115	



### 367/6 TORX® HF Kraffform Plus Screwdriver set with holding function and rack



Code		EAN		
05028059001		4013288	100764	1
				<b>367 TORX® HF</b> 1x TX 10x80; 1x TX 15x80; 1x TX 20x100; 1x TX 25x100; 1x TX 30x115; 1x TX 40x130

### 367/4 TORX® HF Kraffform Plus Screwdriver set with holding function and 300 mm-long blades

- Screwdriver for TORX® screws; holding function and extra-long 300 mm blade

### 367/4 TORX® HF Kraffform Plus Screwdriver set with holding function and 300 mm-long blades

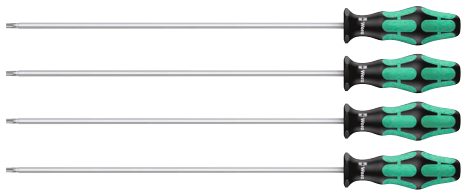

Code		EAN		
05028074001		4013288	138378	1
				<b>367 TORX® HF</b> 1x TX 20x300; 1x TX 25x300; 1x TX 27x300; 1x TX 30x300

### 367/6 TORX® Screwdriver set Kraffform Plus and rack



Code		EAN		
05028062001		4013288	028891	1
				<b>367 TORX®</b> 1x TX 10x80; 1x TX 15x80; 1x TX 20x100; 1x TX 25x100; 1x TX 30x115; 1x TX 40x130

### 334/368/6 Screwdriver set and rack



Code		EAN		
05347778001		4013288	122735	1
				<b>350 PH</b> 1x PH 1x80; 1x PH 2x100 <b>334</b> 1x 1,2x6,5x150 <b>335</b> 1x 0,8x4,0x100 <b>368</b> 1x # 1x80; 1x # 2x100

### 367/6 TORX® B0 Kraftform Plus Screwdriver set and rack

- Screwdrivers for recessed TORX® screws with safety pin

### 367/6 TORX® B0 Kraftform Plus Screwdriver set and rack



Code		EAN		1
05138250001		4013288		
028907		111432		1
367 TORX® B0		1x TX 10x80; 1x TX 15x80; 1x TX 20x100; 1x TX 25x100; 1x TX 30x115; 1x TX 40x130		

### 338/2 Set of actuation tools for terminal blocks (spring cages)

Set with 2 actuation tools for spring terminals. The curved blades also make it easy to operate spring terminals in distribution boxes which cannot be reached with a straight blade.

The blade stays in the terminal block, leaving both hands free to insert the wire. Multi-component Kraftform handle for fast and smooth work.

- Special tool for unlocking contact springs in electrotechnical line terminals
- Due to the curved geometry, even terminal blocks that cannot be reached with normal screwdrivers can be operated
- Suitable for spring terminals with a conductor cross-section of up to 1.5 mm<sup>2</sup> and 2.5 to 4.0 mm<sup>2</sup>

### 338/2 Set of actuation tools for terminal blocks (spring cages)



Code		EAN		1
05008100001		4013288		
225658		207616		1
338		1x 0,4x2,5x81; 1x 0,6x3,5x81		

### 395 H0/7 SM Nutdriver set

- Nutsetter for hexagon head screws
- Hollow shaft for protruding threaded rods, chrome-plated

### 395 H0/7 SM Nutdriver set



Code		EAN		1
05029510001		4013288		
111432		111432		1
395 H0		1x 5,0x90; 1x 5,5x90; 1x 6,0x90; 1x 7,0x90; 1x 8,0x90; 1x 10,0x90; 1x 13,0x90		

### 395 H0/3 Sanitary Nutdriver set

- Nutsetter for hexagon head screws, chrome-plated
- With hollow shaft for protruding threaded rods, particularly suitable for installing/removing mixer taps on washbasins

### 395 H0/3 Sanitary Nutdriver set



Code		EAN		1
05134275001		4013288		
207616		207616		1
395 H0		1x 10,0x90; 1x 13,0x90; 1x 7/16"x90		

### 391/3 Hose clamp screwdriver set

- Flexible, circular blade

#### 391/3 Hose clamp Screwdriver set



Code	EAN		
05135311001	169860		1
		<b>391</b> 1x 6x167; 1x 7x167; 1x 8x167	

### Stubby Set 1 Screwdriver set

Especially small screwdrivers with short blades for hard to reach areas. The 2-component Kraftform handle with its practical combination of hard and soft zones allows for a firm grip and precise working.

The blades have all the benefits of the Wera Bit technology. Special surface treatment of the blades for high corrosion protection and an optimum fit in the screw head.

The hexagon anti-roll protection prevents annoying rolling away of bits in the workplace.

- Short compact shape for working in confined spaces
- Ergonomic 2-component Kraftform handle for precise work
- Blades with the benefits of the Wera Bit technology
- Hexagonal anti-roll feature against rolling away
- Take it easy tool finder: colour coding according to profile and size

#### Stubby Set 1 Screwdriver set



Code	EAN		
05008870001	212337		1
		<b>335 Stubby</b> 1x 0,6x3,5x24,5; 1x 0,8x4,0x24,5; 1x 1,0x5,5x24,5	
		<b>350 PH Stubby</b> 1x PH 1x25; 1x PH 2x25	

### Stubby Set 2 Screwdriver set

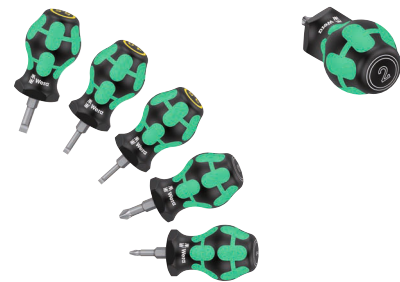

Code	EAN		
05008871001	4013288 212344		1
		<b>335 Stubby</b> 1x 0,6x3,5x24,5; 1x 0,8x4,0x24,5; 1x 1,0x5,5x24,5	
		<b>355 PZ Stubby</b> 1x PZ 1x25; 1x PZ 2x25	

### Stubby Set 3 Screwdriver set

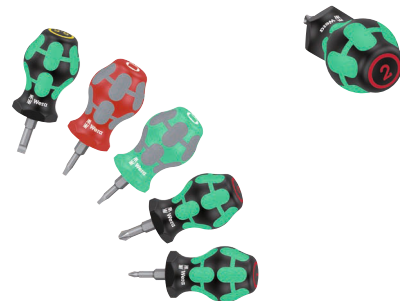

Code	EAN		
05008872001	4013288 214096		1
		<b>350 PH Stubby</b> 1x PH 1x25; 1x PH 2x25	
		<b>335 Stubby</b> 1x 1,0x5,5x24,5	
		<b>368 Stubby</b> 1x # 01x25; 1x # 02x25	

### Stubby Set TX 1 Screwdriver set TORX®

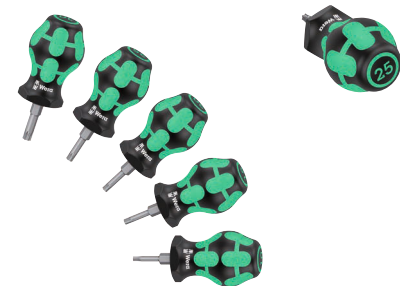

Code	EAN		
05008876001	4013288 212351		1
		<b>367 TORX® Stubby</b> 1x TX 10x25; 1x TX 15x25; 1x TX 20x25; 1x TX 25x25; 1x TX 30x25	

## Bicycle Big Pack 1



Code	EAN		
05004190001	4013288 220745		1
		<b>354 Hex-Plus</b> 1x 2,0x75; 1x 2,5x75	
		<b>454 HF</b> 1x 3x100; 1x 4x150; 1x 5x150; 1x 6x200; 1x 8x200	
		<b>367 TORX®</b> 1x TX 10x80	
		<b>467 TORX® HF</b> 1x TX 20x100; 1x TX 25x200	
		<b>932 A</b> 1x 1,0x5,5x100; 1x 1,2x7,0x125	
		<b>350 PH</b> 1x PH 1x80; 1x PH 2x100	

### 1267 A TORX® Flagdriver for TORX® screws

High quality Wera flagdriver for recessed TORX® screws. High torque transfer for small screws. Particularly suitable for exchanging indexable inserts.

The BlackLaser surface treatment provides outstanding surface protection, even against corrosion, and a long service life. Multi-component for outstanding grip.

- TORX® flagdriver for recessed TORX® screws
- Multi-component handle
- Circular blade with BlackLaser treatment for outstanding surface protection and long service life
- High corrosion protection
- High torque transfer for small screws

### 1267 A TORX® Flagdriver for TORX® screws



Code	EAN						
05026350001	093516	TX 6	33	62,0	3,0	1 19/64"	10
05026351001	093523	TX 7	33	62,0	3,0	1 19/64"	10
05026352001	093530	TX 8	40	69,0	3,0	1 37/64"	10
05026353001	093547	TX 9	40	69,0	3,0	1 37/64"	10
05026354001	093554	TX 10	40	69,0	3,0	1 37/64"	10

### 1267 A TORX PLUS® Flagdriver for TORX PLUS® screws



Code	EAN						
05026360001	093561	6 IP	33	62,0	3,0	1 19/64"	10
05026361001	093578	7 IP	33	62,0	3,0	1 19/64"	10
05026363001	093608	9 IP	40	69,0	3,0	1 37/64"	10

### 1267 B TORX® combination flagdriver for TORX® and hexagon socket screws

High quality Wera flagdrivers with combination profiles for recessed TORX and socket head screws. High torque can be applied to small screws. Particularly suitable for the replacement of indexable inserts. The BlackLaser surface treatment provides outstanding surface protection, even against corrosion, and a long service life. Multi-component for an especially good grip.

### 1267 B TORX® Combination flagdriver for TORX® and hexagon socket screws



Code	EAN						
05026372001	093639	TX 15	3,5	47	86,0	1 27/32"	10
05026373001	093707	TX 15	4	47	86,0	1 27/32"	10
05026374001	093646	TX 20	4	47	86,0	1 27/32"	10

### 1267 B TORX PLUS® Combination flagdriver for TORX PLUS® and hexagon socket screws



Code	EAN						
05026382001	093677	15 IP	3,5	47	86,0	1 27/32"	10



### 9500 Magnetiser SB

Wera magnetiser to magnetise and demagnetise tools to ensure the screw remains firmly on the blade.

- To magnetise and demagnetise tool tips
- To magnetise, move the tool tip along the positive side
- To demagnetise, move the tool tip along the negative side





### 9500 Magnetiser SB



		EAN							
Code		4013288	mm						
05033404001		219589	64,6						1





### 1427 Awl



	EAN								
Code	4013288	mm	mm						
05027405001	019998	105	92	4 3/16"					5

### 1428 Reamer







	EAN								
Code		mm	mm						
05027455001	020000	107	92	4 9/32"					5

### 9611 Magnetic rail for up to 9 Kraftform screwdrivers, empty

- The clips hold the tools perfectly
- With its strong magnet, the rail holds securely to metal surfaces. It can also be bolted to the wall



### 9611 Magnetic rail for up to 9 Kraftform screwdrivers, empty



		EAN							
Code		4013288	mm	mm					
05136414001		230690	30,0	400,0					1



### Rack for Kraftform Micro screwdrivers



									
		mm	mm						
05134002001	100047	190,0	80						1

### Rack for Kraftform screwdrivers



	EAN								
Code	4013288	mm	mm						
05134001001	100030	190,0	50,0						1

### 1440/1442 Screw gripper set

Screw gripper set: attachment tool with holding function for screws. Holds all screw profiles securely on the tool.

During the job, the gripper can be pushed up along the blade so that it is not in the way when working with low-lying screws.

- Screw gripper set
- Attachment tool with holding function for screws
- Holds all screw profiles and sizes securely on the tool
- Made out of stable, elastomer material

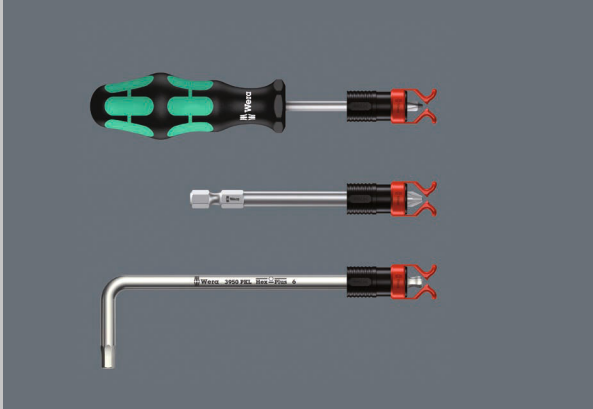

### 1441 SB Screw gripper attachment for screwdriver blades, long bits and L-keys, with holding function for screws



	EAN	∅	h					
Code	4013288	mm	mm					
05073681001	140357	4,5-6,0	41,0					1

### 1440/1442 Screw gripper set



	EAN					
Code	4013288					
05073680001	140340					1
		1440				
		1x 4,5-6,0x41,0				
		1442				
		1x 6,0-8,5x41,0				

### 9108/2 PV Set of installation tools for MC4 Solar connectors

Set consisting of 2 installation tools for MC4 solar connectors (Multi-Contact).

- 2x 9108 installation tools for MC4 solar connectors (Multi-Contact)
- For attaching and disconnecting MC4 connectors
- Glass fibre reinforced plastic

### 9108/2 PV Set of installation tools for MC4 Solar connectors



Code	EAN			
05136700001	4013288 230461			1
		9108	2x 115	

### 9523 Chain riveter spare part kit

- With chain riveter and chain fastener with exchangeable rivet pin for opening and closing bicycle chains. Suitable for single-speed chains, up to 12-speed

### 9523 Chain riveter spare part kit

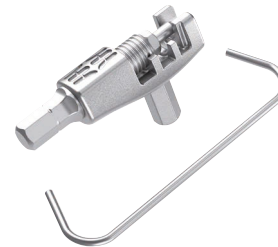

Code	EAN			
05136039001	4013288 227867			1
		9513 Chain Tool		
		9512 Chain-Hook		

### Bicycle Set 13

2-piece tyre lever set for the mobile and stationary use. Both tyre levers are made of glass fibre reinforced plastic: 9502 tyre lever with bit mounting, which is also suitable to secure the French valve, and 9503 tyre lever with valve ejector.

With the glass fibre reinforced plastic tyre levers, the tyres can be safely levered off the rim without damaging the rim.

- 2 tyre levers (9502+9503) made of glass fibre reinforced plastic
- Safely lever the tyres off of the rim without damaging the rim
- The 1/4" hexagon mounting in the 9502 tyre lever allows the fixing of French valves and the use of a 1/4" bit
- 9503 tyre lever with valve ejector and deflater

### Bicycle Set 13



Code	EAN		
	4013288		
05004184001	220585	<b>9502</b> 1x 105.0	5
		<b>9503</b> 1x 105.0	

### Bicycle Set 15

The ultra compact and lightweight bike tools with two quadruple bits and three tyre levers. Four different screw profiles can be operated with just one bit.

Significant weight savings of over 50 %. The enormous space savings make the Bicycle Set 15 perfect for mobile use. The operability of the large profiles is made possible by the spring compression of the small tips. The bit with a 1/4" hexagon drive (Wera connection series 1) can also be used with e.g. bit ratchets and bitholding screwdrivers with Rapidaptor.

The 9504 tyre lever has a 1/4" mounting for using a 1/4" bit. When both 9504 tyre levers are stacked together, a 4-in-1 bit can be inserted and you get a screwdriving tool. The 9505 tyre lever serves as both valve ejector and bleeder valve. The levers and 4-in-1 bits can be clipped together, so that everything is compact and nothing will be lost.

### Bicycle Set 15



Code	EAN		
	4013288		
05004182001	222190	<b>9504</b> 2x 105,0	1
		<b>9505</b> 1x 105,0	
		<b>9506</b> 1x 3,0; 4,0; 5,0; 6,0x37	
		<b>9507</b> 1x 2,5; 5,0; 6,0; TX 25x37	

## Kraftform Micro - the electronic screwdriver

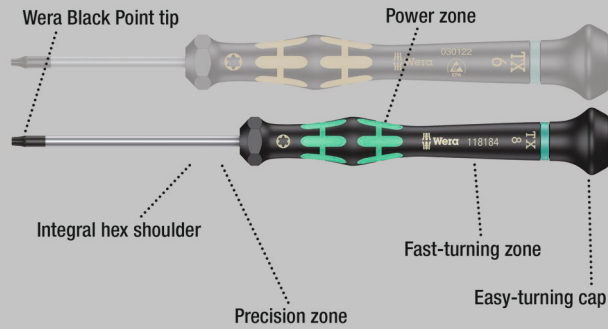

High quality Wera Micro screwdriver for precision mechanical jobs. Rapid twisting results from fixing the hand on the head and using the fast-turning zone just below.

This makes time-consuming grip adjustments unnecessary. Power zones with integrated soft sections ensure the transfer of high loosening and tightening torque; a precision zone for the right rotation angle during fine adjustment work.

The Black Point tip offers optimised corrosion protection and an exact fit. Take it easy tool finder with colour coding according to profiles and size stamp – for simple and rapid accessing of the required tool.

- Multi-component Kraftform Micro handle for fast and ergonomic screwdriving
- Anti-roll feature and swivel cap for rapid twisting
- The Wera Black Point tip offers an exact fit and optimum corrosion protection
- Take it easy tool finder: colour coding according to profile and size
- E.g. for electricians, opticians, precision mechanics, jewellers or IT hardware fitters

## 2055 Screwdriver for slotted screws for electronic applications

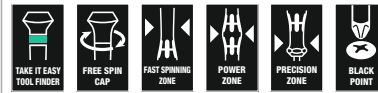

	EAN							
Code	4013288	mm	mm	mm	mm	mm		
05117990001	108418	0,16	0,8	40	97	2,0	1/32"	10
05117991001	108425	0,18	1,0	40	97	2,0	0,04"	10
05117992001	108432	0,20	1,2	40	97	2,0	0,05"	10
05118002001	031877	0,23	1,5	40	97	2,0	1/16"	10
05118003001	108456	0,23	1,5	60	97	2,0	1/16"	10
05118000001	031860	0,25	1,2	40	97	2,0	0,05"	10
05117993001	108463	0,30	1,8	40	97	2,0	0,07"	10
05118004001	031884	0,30	1,8	60	97	2,0	0,07"	10
05118017001	151704	0,30	2,0	50	97	2,0"	5/64"	10
05117997001	194824	0,35	2,5	40	97	2,5	3/32"	10
05118005001	108470	0,40	2,0	40	97	2,5	5/64"	10
05118006001	031891	0,40	2,0	60	97	2,5	5/64"	10
05118007001	108487	0,40	2,0	100	97	2,5	5/64"	10
05117994001	108494	0,40	2,5	50	97	2,5	3/32"	10
05118008001	031907	0,40	2,5	80	97	2,5	3/32"	10
05117995001	108517	0,50	3,0	50	97	3,0	1/8"	10
05118010001	031914	0,50	3,0	80	97	3,0	1/8"	10
05118012001	031921	0,60	3,5	80	97	4,0	9/64"	10
05118014001	031938	0,80	4,0	80	97	4,0	5/32"	10

## 2055 PZ Screwdriver for Pozidriv screws for electronic applications



	EAN						
Code	4013288		mm	mm	mm		
05118030001	032195	PZ 0	60	97	3,0	2 3/8"	10
05118032001	032201	PZ 1	80	97	4,0	3 1/16"	10



## 2050 PH Screwdriver for Phillips screws for electronic applications



	EAN	+	mm	mm	mm	mm	
<b>Code</b>	4013288						
05345290001 <sup>1)2)</sup>	164506	PH 000	40	97	1,5/2,5	1 9/16"	10
05118019001 <sup>1)2)</sup>	108562	PH 00	40	97	1,8/2,5	1 9/16"	10
05118020001 <sup>1)</sup>	031969	PH 00	60	97	2,5	2 3/8"	10
05118026001 <sup>3)</sup>	194800	PH 0	40	97	3,0	1 9/16"	10
05118022001 <sup>3)</sup>	031976	PH 0	60	97	3,0	2 3/8"	10
05118023001	108579	PH 1	60	97	4,0	2 3/8"	10
05118024001	031983	PH 1	80	97	4,0	3 1/8"	10

<sup>1)</sup> Optimised for Asian PH screws

<sup>2)</sup> On the output side, the blade is turned to a nominal length of 10 mm

<sup>3)</sup> Size 0 modified according to JCS 0 (Japanese Camera Industrial Standard)

## 2067 TORX® HF Screwdriver with holding function for electronic applications

- Holding function for TORX® screws

## 2067 TORX® HF Screwdriver with holding function for electronic applications



	EAN	*	mm	mm	mm	mm	
<b>Code</b>	4013288						
05118180001	108623	TX 4	40	97	2,5	1 9/16"	5
05118181001	108630	TX 5	40	97	3,0	1 9/16"	5
05118182001	108647	TX 6	40	97	3,0	1 9/16"	5
05118183001	108654	TX 7	60	97	3,0	2 3/8"	5
05118184001	108661	TX 8	60	97	3,0	2 3/8"	5
05118185001	108678	TX 9	60	97	4,0	2 3/8"	5
05118186001	108685	TX 10	60	97	4,0	2 3/8"	5

## 2067 TORX® Screwdriver for TORX® screws for electronic applications

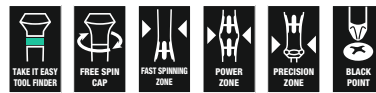

	EAN	*	mm	mm	mm	mm	
<b>Code</b>	4013288						
05118035001	108593	TX 1	40	97	2,0	1 9/16"	5
05118036001	108609	TX 2	40	97	2,0	1 9/16"	5
05118037001	108616	TX 3	40	97	2,0	1 9/16"	5
05118039001	040084	TX 4	40	97	2,5	1 9/16"	5
05118040001	032218	TX 5	40	97	3,0	1 9/16"	5
05118042001	032225	TX 6	40	97	3,0	1 9/16"	5

## 2067 TORX® B0 Screwdriver for tamper-proof TORX® screws for electronic applications

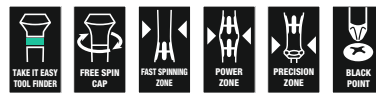

	EAN	*	mm	mm	mm	mm	
<b>Code</b>	4013288						
05118044001	032232	TX 7	60	97	3,0	2 3/8"	5
05118046001	032249	TX 8	60	97	3,0	2 3/8"	5
05118048001	032256	TX 9	60	97	4,0	2 3/8"	5
05118050001	032263	TX 10	60	97	4,0	2 3/8"	5
05118052001	032270	TX 15	60	97	4,0	2 3/8"	5
05118054001	032287	TX 20	60	97	4,0	2 3/8"	5

## 2067 IPR TORX PLUS® Screwdriver for electronic applications



	EAN	*	mm	mm	mm	mm	
<b>Code</b>	4013288						
05030160001	178749	1 IPR	40	97	2,0	1 37/64"	5

<sup>1)</sup> Without bore hole

## Hex-Plus - lets hexagon socket screws last longer

Deformation of the screws is reduced

Above-average service life

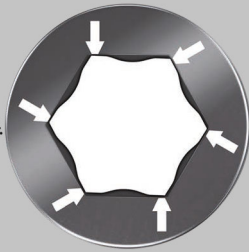

- Kraftform Micro screwdriver for hexagon socket screws
- Hex-Plus allows socket head screws to live longer

### 2054 Screwdriver for hexagon socket screws for electronic applications

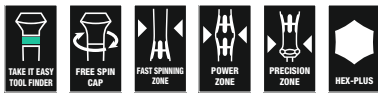

Code	EAN	⊕	⊙	⌵	⌵	∅	⌵	📦
Code	4013288	mm		mm	mm	mm		
05118060001	032072	0,7		40	97	3,0	1 9/16"	5
05118062001	032089	0,9		40	97	3,0	1 9/16"	5
05118064001	032096	1,3		40	97	3,0	1 9/16"	5
05118066001	032102	1,5		60	97	3,0	2 3/8"	5
05118068001	032119	2		60	97	3,0	2 3/8"	5
05118070001	032126	2,5		60	97	4,0	2 3/8"	5
05118072001	032133	3,0		60	97	4,0	2 3/8"	5
05345284001	152206	-	0,028"	40	97	3,0	1 9/16"	5
05345285001	152213	-	0,035"	40	97	3,0	1 9/16"	5
05118074001	032140	-	0,05"	40	97	3,0	1 9/16"	5
05118076001	032157	-	1/16"	60	97	3,0	2 3/8"	5
05118078001	032164	-	5/64"	60	97	3,0	2 3/8"	5
05118080001	032171	-	3/32"	60	97	4,0	2 3/8"	5
05118082001	032188	-	7/64"	60	97	4,0	2 3/8"	5
05118075001	108807	-	1/8"	60	97	4,0	2 3/8"	5

## 2052 Ball end hexagon screwdriver for electronic applications

- Ballpoint for dependable working even in difficult installation situations

### 2052 Ball end hexagon screwdriver for electronic applications

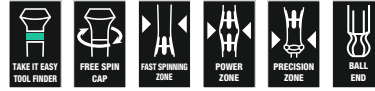

Code	EAN	⊕	⊙	⌵	⌵	∅	⌵	📦
Code	4013288	mm		mm	mm	mm		
05118089001	108814	1,3		60	97	3,0	2 3/8"	5
05118090001	031990	1,5		60	97	3,0	2 3/8"	5
05118092001	032003	2,0		60	97	3,0	2 3/8"	5
05118094001	032010	2,5		60	97	4,0	2 3/8"	5
05118096001	032027	3,0		60	97	4,0	2 3/8"	5
05118098001	032034	-	1/16"	60	97	3,0	2 3/8"	5
05118100001	032041	-	5/64"	60	97	3,0	2 3/8"	5
05118102001	032058	-	3/32"	60	97	3,0	2 3/8"	5
05118106001	110954	-	7/64"	60	97	4,0	2 3/8"	5
05118103001	108821	-	1/8"	60	97	4,0	2 3/8"	5

### 2072 Screwdriver for Microstix® screws



Code	EAN	⊕	⌵	⌵	∅	⌵	📦
Code	194817	m	mm	mm	mm		
05118145001	194817	m	40	97	2,5	1 9/16"	5

## 2069 Nutdriver for electronic applications



	EAN							
Code	4013288	mm		mm	mm	mm		
05118108001	108852	1,5		60	97	5,7	2 3/8"	5
05118109001	108869	1,8		60	97	5,7	2 3/8"	5
05118110001	032300	2,0		60	97	5,7	2 3/8"	5
05118112001	032317	2,5		60	97	5,7	2 3/8"	5
05118114001	032324	3,0		60	97	5,7	2 3/8"	5
05118116001	032331	3,2		60	97	5,7	2 3/8"	5
05118118001	032348	3,5		60	97	5,7	2 3/8"	5
05118120001	032355	4,0		60	97	5,7	2 3/8"	5
05118122001	032362	4,5		60	97	6,4	2 3/8"	5
05118124001	032379	5,0		60	97	7,0	2 3/8"	5
05118126001	032386	5,5		60	97	7,8	2 3/8"	5
05345281001	150189	6,0		60	97	8,5	2 3/8"	5
05118128001	032393	-	3/32"	60	97	5,7	2 3/8"	5
05118130001	032409	-	7/64"	60	97	5,7	2 3/8"	5
05118132001	032416	-	1/8"	60	97	5,7	2 3/8"	5
05118134001	032423	-	9/64"	60	97	5,7	2 3/8"	5
05118136001	032430	-	5/32"	60	97	5,7	2 3/8"	5
05118135001	110596	-	3/16"	60	97	6,6	2 3/8"	5
05118137001	112019	-	7/32"	60	97	7,8	2 3/8"	5
05345282001	150196	-	1/4"	60	97	9,0	2 3/8"	5

## 1429 Chip Removal Tool

- Lifting fork to remove firmly-fitted parts from a circuit board after desoldering

## 1429 Chip Removal Tool



	EAN							
Code	4013288	mm	mm	mm	mm			
05027456001	112187	1,0	3,5	50	97			10

## 1013 Kraftform Micro Bitholding screwdriver

Kraftform Micro holder with ergonomic Kraftform handle for fast and low-fatigue working.

The anti-roll feature prevents any bothersome rolling away at the workplace.

Suitable for take-up of bits with 4 mm halfmoon drive and bits with 4 mm HIOS drive. Ideal for applications on smartphones, cell phones, cameras, electronic equipment, in dental laboratories and dental surgeries.

- Kraftform Micro bit holder
- Multi-component Kraftform Micro handle with anti-roll feature and swivel cap
- Suitable for take-up of bits with 4 mm halfmoon drive and bits with 4 mm HIOS drive
- Applications e.g. on smartphones, mobile phones, cameras, electronic equipment

## 1013 Kraftform Micro Bitholding screwdriver



	EAN						
Code	4013288	mm	mm				
05051276001	183699	23	97	29/32"			1

## Kraftform Micro Big Pack 1 Screwdriver set for electronic applications

Wera Micro screwdriver set for fine mechanical screw connections. By supporting the hand on the rotating cap, and by the fast rotating zone below the rotating cap, lightning fast turning is possible.

Time-consuming hand switching is eliminated. Storage and transport in a robust roll-bag, so the correct tool is always at hand.

With Take it easy tool finder: colour coding by profile and size stamping.

- 25-piece Kraftform Micro screwdriver set in a robust and compact roll bag
- Kraftform Micro handle for fast and ergonomic working
- Tools with anti-roll protection and rotating cap for fast turning
- The Wera Black Point tip offers an exact fit and optimum corrosion protection
- Take it easy tool finder: colour coding according to profile and size
- Suitable for electricians, opticians, precision mechanics, jewellers or computer hardware engineers

## Kraftform Micro Big Pack 1 Screwdriver set for electronic applications

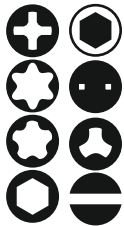

Code	EAN		
0513400001	4013288 209580		1
		<b>2050 PH Micro</b> 1x PH 000x40 <sup>1) 2)</sup> ; 1x PH 00x40 <sup>1) 2)</sup> ; 1x PH 0x40 <sup>3)</sup>	
		<b>2067 TORX®</b> 1x TX 5x40; 1x TX 6x40	
		<b>2067 TORX® HF</b> 1x TX 5x40; 1x TX 6x40; 1x TX 7x60; 1x TX 8x60; 1x TX 10x60	
		<b>2067 TORX PLUS® IPR Micro</b> 1x 1 IPRx40	
		<b>2054 Micro</b> 1x 0,9x40; 1x 1,3x40; 1x 1,5x60; 1x 2x60	
		<b>2035 Micro</b> 1x 0,23x1,5x40; 1x 0,30x1,8x60; 1x 0,35x2,5x40; 1x 0,40x2,0x60; 1x 0,50x3,0x80	
		<b>2069 Micro</b> 1x 4,0x60; 1x 5,5x60	
		<b>2072 1x mx40</b>	
		<b>1429 1x 1,0x3,5x50</b>	
		<b>K240 1x 50,0x240,0</b>	

<sup>1)</sup> Optimised for Asian PH screws

<sup>2)</sup> On the output side, the blade is turned to a nominal length of 10 mm

<sup>3)</sup> Size 0 modified according to JCIS 0 (Japanese Camera Industrial Standard)

## Kraftform Micro 12 Universal 1 Screwdriver set for electronic applications

- Kraftform Micro set in a robust pouch

## Kraftform Micro 12 Universal 1 Screwdriver set for electronic applications

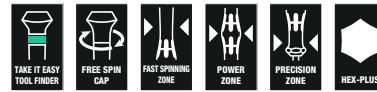

Code	EAN		
05073675001	4013288 165695		1
		<b>2050 PH Micro</b> 1x PH 00x60 <sup>1)</sup> ; 1x PH 0x60 <sup>2)</sup>	
		<b>2067 TORX® HF</b> 1x TX 5x40; 1x TX 6x40	
		<b>2035 Micro</b> 1x 0,23x1,5x40; 1x 0,30x1,8x60; 1x 0,40x2,0x60; 1x 0,40x2,5x80; 1x 0,50x3,0x80	
		<b>2054 Micro</b> 1x 0,9x40; 1x 1,5x60; 1x 2x60	

<sup>1)</sup> Optimised for Asian PH screws

<sup>2)</sup> Size 0 modified according to JCIS 0 (Japanese Camera Industrial Standard)

## Kraftform Micro 12 Electronics 1 Screwdriver set for electronic applications

- Kraftform Micro screwdriver for slotted, Phillips, TORX® B0, Hex, IPR and Microstix® screws plus chip lifter

### Kraftform Micro 12 Electronics 1 Screwdriver set for electronic applications



Code	EAN			
05073677001	194831			1
		+	2050 PH Micro 1x PH 000x40 <sup>1) 2)</sup> ; 1x PH 00x40 <sup>1) 2)</sup> ; 1x PH 0x40 <sup>3)</sup>	
		⊕	2067 TORX® B0 Micro 1x TX 8x60; 1x TX 10x60	
		⊕	2067 TORX PLUS® IPR Micro 1x 1 IPRx40	
		⊖	2035 Micro 1x 0,23x1,5x40; 1x 0,35x2,5x40	
		⊙	2069 Micro 1x 2,5x60; 1x 3,0x60	
		⊕	2072 1x mx40	
		⊙	1429 1x 1,0x3,5x50	

<sup>1)</sup> Optimised for Asian PH screws

<sup>2)</sup> On the output side, the blade is turned to a nominal length of 10 mm

<sup>3)</sup> Size 0 modified according to JCIS 0 (Japanese Camera Industrial Standard)

## Kraftform Kompakt Micro 11 Electronics 1

Kraftform Kompakt Micro Set for precision mechanical applications; suitable for the take-up of bits with 4 mm halfmoon drive (Wera series 9) and bits with 4 mm HIOS drive (Wera series 21); handle/ interchangeable blade system for rapid blade change; Kraftform Micro handle with twist cap and free-turning zone for rapid twisting, making any time-consuming repositioning of the fingers unnecessary; power zone with integrated soft zones for the transfer of higher tightening and loosening torque; precision zone directly above the blade for the right angle for adjustment work; comes with 10 bits for manual as well as power tool operations; rapid fixing of the bit: just push the bit into the insert for automatic locking and a secure fit.

To change the bit, simply push the sleeve forward and remove; free-turning sleeve for simple guidance of the tool during the screwdriving process.

### Kraftform Kompakt Micro 11 Electronics 1



Code	EAN			
05073676001	194848			1
		⊕	1013 Kraftform Micro 1x 97	
		+	851/9 C 1x PH 000x44 <sup>1)</sup> ; 1x PH 00x44 <sup>1)</sup> ; 1x PH 0x44 <sup>2)</sup>	
		⊕	867/9 C TORX® 1x TX 8x44	
		⊕	867/9 C TORX PLUS® 1x 3 IPx44	
		⊕	867/9 IPR TORX® PLUS 1x 1 IPRx44	
		⊖	800/9 C 1x 0,35x2,5x44	
		⊕	872/9 1x mx44	
		⊙	869/9 1x 2,5x44,0; 1x 3,0x44,0	

<sup>1)</sup> Optimised for Asian PH screws

<sup>2)</sup> Size 0 modified according to JCIS 0 (Japanese Camera Industrial Standard)

### Kraftform Kompakt Micro 11 Universal 1



Code	EAN		
05135938001	4013288 178343		1
		<b>1013 Kraftform Micro</b> 1x 97	
		<b>851/9 C</b> 1x PH 00x44 <sup>1)</sup> ; 1x PH 0x44 <sup>2)</sup> ; 1x PH 1x44 <sup>1)</sup>	
		<b>840/9 C</b> 1x 1,5x44; 1x 2,0x44	
		<b>800/9 C</b> 1x 0,23x1,5x44; 1x 0,40x2,0x44; 1x 0,50x3,0x44	
		<b>867/9 C TORX®</b> 1x TX 5x44; 1x TX 6x44	

<sup>1)</sup> Optimised for Asian PH screws

<sup>2)</sup> Size 0 modified according to JCSIS 0 (Japanese Camera Industrial Standard)

### 2035/6 A Screwdriver set and rack for electronic applications

- With useful plastic rack

### 2035/6 A Screwdriver set and rack for electronic applications



Code	EAN		
05118150001	4013288 031945		1
		<b>2050 PH Micro</b> 1x PH 00x60 <sup>1)</sup> ; 1x PH 0x60 <sup>2)</sup>	
		<b>2035 Micro</b> 1x 0,30x1,8x60; 1x 0,40x2,0x60; 1x 0,40x2,5x80; 1x 0,50x3,0x80	

<sup>1)</sup> Optimised for Asian PH screws

<sup>2)</sup> Size 0 modified according to JCSIS 0 (Japanese Camera Industrial Standard)

### 2035/6 B Screwdriver set and rack for electronic applications

- With useful plastic rack

### 2035/6 B Screwdriver set and rack for electronic applications



Code	EAN		
05118152001	4013288 031952		1
		<b>2050 PH Micro</b> 1x PH 0x60 <sup>1)</sup> ; 1x PH 1x80	
		<b>2035 Micro</b> 1x 0,40x2,5x80; 1x 0,50x3,0x80; 1x 0,60x3,5x80; 1x 0,80x4,0x80	

<sup>1)</sup> Size 0 modified according to JCSIS 0 (Japanese Camera Industrial Standard)

### 2050/6 Screwdriver set and rack for electronic applications

- Kraftform Micro screwdriver for slotted, Phillips-Recess, IPR and Microstix® screws
- With useful plastic rack

### 2050/6 Screwdriver set and rack for electronic applications



Code	EAN		
05030181001	4013288 194794		1
		<b>2050 PH Micro</b> 1x PH 000x40 <sup>1)</sup> <sup>2)</sup> ; 1x PH 00x40 <sup>1)</sup> <sup>2)</sup> ; 1x PH 0x40 <sup>3)</sup>	
		<b>2067 TORX PLUS® IPR Micro</b> 1x 1 IPRx40	
		<b>2072</b> 1x mx40	
		<b>2035 Micro</b> 1x 0,35x2,5x40	

<sup>1)</sup> Optimised for Asian PH screws

<sup>2)</sup> On the output side, the blade is turned to a nominal length of 10 mm

<sup>3)</sup> Size 0 modified according to JCSIS 0 (Japanese Camera Industrial Standard)

### 2052/6 Hexagon Screwdriver set and rack for electronic applications

- Kraftform Micro screwdriver with ballpoint for hexagon socket screws

### 2052/6 Hexagon Screwdriver set and rack for electronic applications

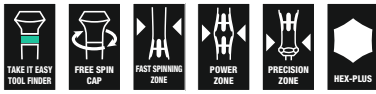

	<b>Code</b>	<b>EAN</b>		
	05118156001	4013288 032065		1
			<b>2052 Micro</b> 1x 1,5x60; 1x 2,0x60; 1x 2,5x60; 1x 3,0x60	
			<b>2054 Micro</b> 1x 0,9x40; 1x 1,3x40	

### 2067/6 TORX® B0 Screwdriver set and rack for electronic applications

- Kraftform Micro screwdriver set for recessed TORX® screws with safety pin

### 2067/6 TORX® B0 Screwdriver set and rack for electronic applications



	<b>Code</b>	<b>EAN</b>		
	05118154001	4013288 032294		1
			<b>2067 TORX® B0 Micro</b> 1x TX 7x60; 1x TX 8x60; 1x TX 9x60; 1x TX 10x60; 1x TX 15x60; 1x TX 20x60	

### 2069/6 Screwdriver set and rack for electronic applications

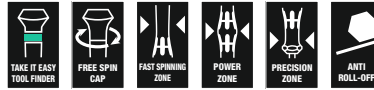

	<b>Code</b>	<b>EAN</b>		
	05118158001	4013288 032447		1
			<b>2069 Micro</b> 1x 2,0x60; 1x 2,5x60; 1x 3,0x60; 1x 3,5x60; 1x 4,0x60; 1x 5,0x60	

### Series 400 T-Handle

The ergonomically shaped 2-component T-handle with finger recesses and pleasant surface facilitates very high power transmission and fatigue-free working.

Due to the special surface treatment, the blades receive a high level of corrosion protection. The optimum fitting accuracy of the screw is also guaranteed.

- T-handle screwdriver for the transmission of particularly high tightening and loosening moments
- Ergonomic 2-component handle with finger handle recesses and pleasant surface feel for very high power transmission and fatigue-free working.
- Take it easy tool finder: colour coding according to profile and size
- With additional short arm for the transmission of extremely high torques due to the leverage of the long arm

### 454 T-handle hexdriver



	<b>EAN</b>							
<b>Code</b>	4013288	mm	mm	mm	mm	mm	mm	
05023330001	207753	2	100	12	32	65	4"	5
05023332001	207814	2,5	100	12	32	65	4"	5

**454 HF T-handle hexagon screwdriver Hex-Plus with holding function**



		EAN						
Code	4013288		mm	mm	mm	mm		
05023334001	207838	3	100	15	38	77		5
05023338001	207883	4	100	15	38	77		5
05023339001	207876	4	150	15	38	77		5
05023340001	207890	4	200	15	38	77		5
05023342001	207913	5	100	20	49	99		5
05023343001	207920	5	150	20	49	99		5
05023344001	207937	5	200	20	49	99		5
05023346001	207951	6	100	20	49	99		5
05023347001	207968	6	150	20	49	99		5
05023348001	207975	6	200	20	49	99		5
05023350001	208002	7	200	20	49	99		5
05023351001	208019	8	100	20	49	99		5
05023352001	208026	8	150	20	49	99		5
05023353001	208033	8	200	20	49	99		5
05023354001	208057	10	100	20	49	99		5
05023355001	208064	10	200	20	49	99		5

**454 Imperial T-handle hexagon screwdriver Hex-Plus, imperial**

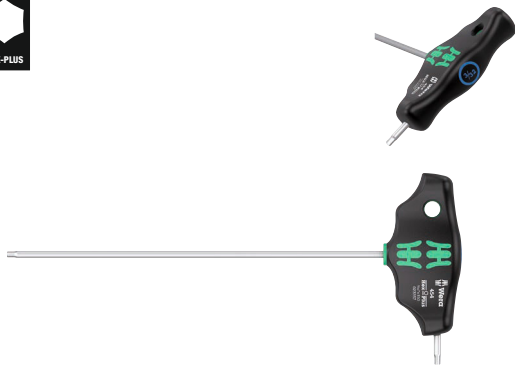

		EAN						
Code	4013288		mm	mm	mm	mm		
05023356001	214133	5/64"	150	12	32	65		5
05023357001	208071	3/32"	150	12	32	65		5
05023358001	208088	7/64"	150	12	32	65		5

**454 HF T-handle hexagon screwdriver Hex-Plus with holding function, imperial**

- With holding function (HF) on the long arm to securely hold the screw on the tool

**454 HF T-handle hexagon screwdriver Hex-Plus with holding function, imperial**



		EAN						
Code	4013288		mm	mm	mm	mm		
05023359001	208095	1/8"	150	15	38	77		5
05023360001	208101	9/64"	150	15	38	77		5
05023361001	208118	5/32"	150	15	38	77		5
05023362001	208125	3/16"	150	20	49	99		5
05023363001	208132	7/32"	150	20	49	99		5
05023364001	208149	1/4"	150	15	49	99		5
05023365001	208156	5/16"	150	20	49	99		5
05023366001	208163	3/8"	150	20	49	99		5

**467 TORX® HF T-handle screwdriver with holding function**

- With holding function (HF) on the long arm to securely hold the screw on the tool

**467 TORX® HF T-handle screwdriver with holding function**

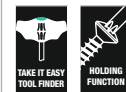

		EAN							
Code	4013288			mm	mm	mm	mm	mm	
05023367001	208217	TX 6	100	12	32	65	3,0	5	
05023368001	208224	TX 7	100	12	32	65	3,0	5	
05023369001	208231	TX 8	100	12	32	65	3,5	5	
05023370001	208248	TX 9	100	12	32	65	3,5	5	
05023371001	208255	TX 10	100	12	32	65	4,0	5	
05023372001	208262	TX 15	100	15	38	77	4,0	5	
05023373001	208279	TX 20	100	15	38	77	4,5	5	
05023374001	208286	TX 20	200	15	38	77	4,5	5	
05023375001	208293	TX 25	100	15	38	77	5,0	5	
05023376001	208309	TX 25	200	15	38	77	5,0	5	
05023377001	208316	TX 27	200	20	49	99	6,0	5	
05023378001	208323	TX 30	200	20	49	99	6,0	5	
05023379001	208330	TX 40	200	20	49	99	8,0	5	
05023380001	208347	TX 45	200	20	49	99	9,0	5	



### 495 T-handle socket wrench screwdrivers

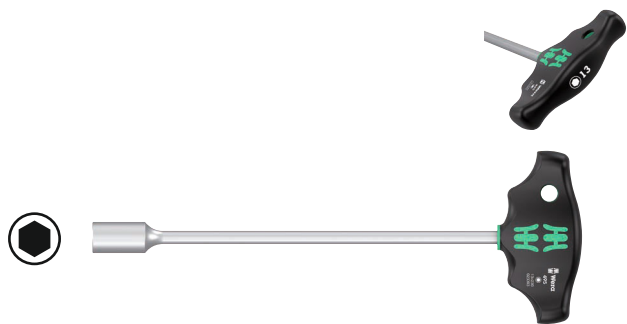

Code	EAN	Hex	mm	mm	mm	mm	mm	mm
05023381001	208354	5	230	38	77	9"		5
05023382001	208361	5,5	230	38	77	9"		5
05023383001	208378	6	230	38	77	9"		5
05023384001	208385	7	230	49	99	9"		5
05023385001	208392	8	230	49	99	9"		5
05023386001	208408	9	230	49	99	9"		5
05023387001	208415	10	230	49	99	9"		5
05023389001	208439	11	230	49	99	9"		5
05023391001	208477	12	230	49	99	9"		5
05023393001	208491	13	230	49	99	9"		5

### Radidaptor - the amazing compact multifunction tool

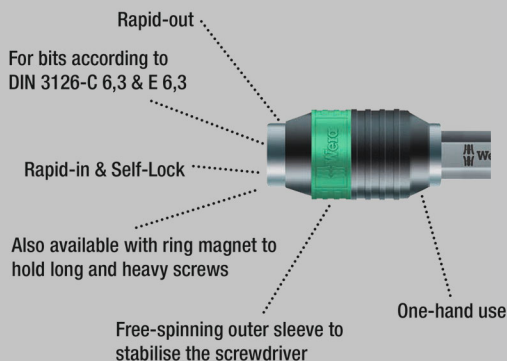

The ergonomically shaped 2-component T-handle with finger recesses and pleasant surface facilitates very high power transmission and fatigue-free working.

For bits with 1/4" hex head drive as per DIN ISO 1173-C 6.3 and E 6.3. With Radidaptor technology for lightning-fast bit changes.

- T-handle screwdriver for the transmission of particularly high tightening and loosening moments
- Ergonomic 2-component handle with finger handle recesses and pleasant surface feel for very high power transmission and fatigue-free working.
- With Radidaptor technology for lightning-fast bit changes
- Bitholders, magnetic, for easier application of the screw
- For bits with 1/4" external hexagon drive as per DIN ISO 1173-C 6.3 and E 6.3

### 416 R T-handle bitholding screwdriver Rapidaptor



Code	EAN	Hex	mm	mm	mm	mm	mm
05023404001	214157	1/4"	45	44	99	1 25/32"	2

### 416 RA T-handle bitholding screwdriver with ratchet function and Rapidaptor quick-release chuck

The integrated ratchet with fine toothing (80 teeth/return angle 4.5°) eases and accelerates screwdriving without having to reposition the tool. The ratchet mechanism completely embedded in the handle ensures very handy and comfortable work. With reversing lever for comfortable clockwise/counterclockwise direction change in one-hand operation.

The ergonomic shape of the handle fills the ball of the hand well, the fingers lie securely in the softly rounded recessed grips. The whole hand comes into contact with the handle, friction loss between hand and handle is avoided.

Bit holder for bits with 1/4" external hexagon drive as per DIN ISO 1173-C 6.3 and E 6.3. With Rapidaptor technology for lightning-fast bit changes.

- The integrated ratchet with fine toothing ensures fast and safe working
- Reversing lever for comfortable clockwise/counterclockwise direction change
- Convenient working thanks to the ratchet mechanism fully embedded in the handle
- Ergonomic 2-component handle with finger handle recesses and pleasant surface feel for very high power transmission and fatigue-free working
- Fast-rotating sleeve for extremely high working speed
- Rapidaptor bitholding screwdriver with fast-rotating sleeve for lightning-fast bit changes and high working speeds
- For bits with 1/4" external hexagon drive as per DIN ISO 1173-C 6.3 and E 6.3

### 416 RA T-handle bitholding screwdriver with ratchet function and Rapidaptor quick-release chuck



<b>Code</b>	<b>EAN</b>							
05023461001	222824	1/4"	45	44	99	1 25/32"		2

### 411 A RA T-handle adapter screwdriver with ratchet function, 1/4"

The integrated ratchet with fine toothing (80 teeth/return angle 4.5°) eases and accelerates screwdriving without having to reposition the tool.

The ratchet mechanism completely embedded in the handle ensures very handy and comfortable work. With reversing lever for comfortable clockwise/counterclockwise direction change in one-hand operation.

The ergonomic shape of the handle fills the ball of the hand well, the fingers lie securely in the softly rounded recessed grips. The whole hand comes into contact with the handle, friction loss between hand and handle is avoided. 1/4" socket mounting with secure locking mechanism.

- The integrated ratchet with fine toothing ensures fast and safe working
- Reversing lever for comfortable clockwise/counterclockwise direction change
- Convenient working thanks to the ratchet mechanism fully embedded in the handle
- Ergonomic 2-component handle with finger handle recesses and pleasant surface feel for very high power transmission and fatigue-free working
- Fast-rotating sleeve for extremely high working speed
- 1/4" socket mounting with secure ball lock

### 411 A RA T-handle adapter screwdriver with ratchet function, 1/4"



	<b>EAN</b>							
<b>Code</b>	4013288							
05023460001	222817	1/4"	45	44	99	1 25/32"		2

### 454/7 HF Set 1 screwdriver set T-handle screwdrivers Hex-Plus with holding function

- With holding function (HF) on the long arm to securely hold the screw on the tool

#### 454/7 HF Set 1 screwdriver set T-handle screwdrivers Hex-Plus with holding function



Code	EAN		
05023450001	214829		1
		○ 454 1x 2,5x100	
		○ 454 HF 1x 3x100; 1x 4x100; 1x 5x150; 1x 6x150; 1x 8x200; 1x 10x200	
		Rack 2x 190,0x50,0	

### 454/7 HF Set 2 Screwdriver set T-handle Hex-Plus screwdrivers with holding function

- T-handle screwdriver for the transmission of particularly high tightening and loosening torque
- Ergonomic 2-component handle with finger handle recesses and pleasant surface feel for very high power transmission and fatigue-free working
- Take it easy tool finder: colour coding according to profile and size
- With additional short arm for the transmission of extremely high torques due to the leverage of the long arm
- With holding function (HF) on the long arm to securely hold the screw on the tool
- Including metal rack; the rack can be placed upright or hung on the tool wall.

#### 454/7 HF Set 2 Screwdriver set T-handle Hex-Plus screwdrivers with holding function



Code	EAN		
05023453001	221742		1
		○ 454 1x 2,5x100	
		○ 454 HF 1x 3x100; 1x 4x100; 1x 5x150; 1x 6x150; 1x 8x200; 1x 10x200	
		9604 1x 214,0x78,0	

### 454/10 HF Set Imperial 1 screwdriver set T-handle screwdrivers Hex-Plus with holding function, imperial

- With holding function (HF) on the long arm to securely hold the screw on the tool

### 454/10 HF Set Imperial 1 screwdriver set T-handle screwdrivers Hex-Plus with holding function, imperial

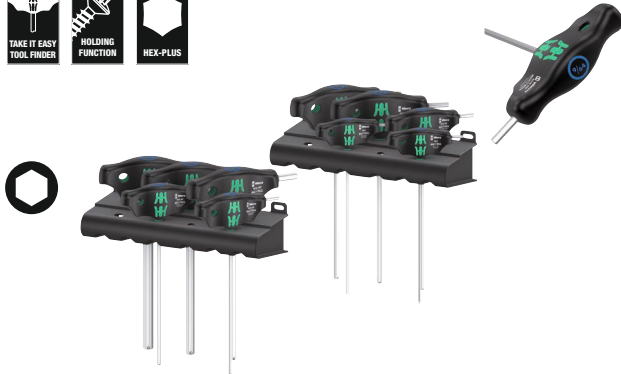

Code		EAN		
		4013288		
05023451001	214836			1
		○	<b>454 Imperial</b> 1x 3/32"x150; 1x 7/64"x150	
		○	<b>454 Imperial HF</b> 1x 1/8"x150; 1x 9/64"x150; 1x 5/32"x150; 1x 3/16"x150; 1x 7/32"x150; 1x 1/4"x150; 1x 5/16"x150; 1x 3/8"x150	
			<b>Rack</b> 2x 190,0x50,0	

### 454/10 HF Set Imperial 2 Screwdriver set T-handle Hex-Plus screwdrivers with holding function, imperial

T-handle screwdriver: The ideal handle shape allows the transmission of particularly high tightening and loosening torque. The ergonomic shape of the handle fills the palm of the hand well, the fingers lie safely in the soft rounded handle recesses. The whole hand makes contact with the handle and friction losses between the hand and the handle are avoided.

With holding function to securely hold the hexagon socket screw on the tool. Special surface treatment of the blades for high corrosion protection and optimum fitting accuracy in the screw. Including metal rack for storage. The rack can be placed on the workbench or hung on the tool wall.

- Including metal rack; the rack can be placed upright or hung on the tool wall.

### 454/10 HF Set Imperial 2 Screwdriver set T-handle Hex-Plus screwdrivers with holding function, imperial



Code		EAN		
		4013288		
05023454001	221735			1
		○	<b>454 Imperial</b> 1x 3/32"x150; 1x 7/64"x150	
		○	<b>454 Imperial HF</b> 1x 1/8"x150; 1x 9/64"x150; 1x 5/32"x150; 1x 3/16"x150; 1x 7/32"x150; 1x 1/4"x150; 1x 5/16"x150; 1x 3/8"x150	
			<b>9605</b> 1x 214,0x78,0	

### 454/5 HF SHK Set 1 Screwdriver set T-handle screwdriver Hex-Plus with holding function

- Tool set with 5 T-handle screwdrivers for operations in plumbing, heating and air conditioning
- Extra long blades
- With holding function (HF) on the long arm to securely hold the screw on the tool

### 454/5 HF SHK Set 1 Screwdriver set T-handle screwdriver Hex-Plus with holding function



Code	EAN			
05136070001	228000			1
			454 HF 1x 4x200; 1x 5x200; 1x 6x200; 1x 7x200; 1x 8x200	

### 467/7 TORX® HF Set 1 screwdriver set T-handle TORX® screwdrivers with holding function

- With holding function (HF) on the long arm to securely hold the screw on the tool

### 467/7 TORX® HF Set 1 screwdriver set T-handle TORX® screwdrivers with holding function

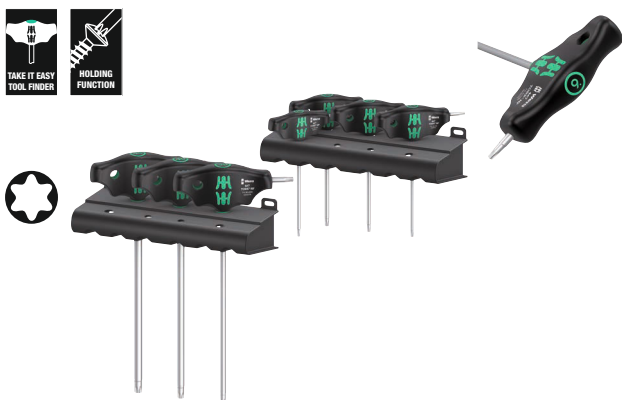

Code	EAN			
05023452001	214874			1
			467 TORX® HF 1x TX 10x100; 1x TX 15x100; 1x TX 20x100; 1x TX 25x100; 1x TX 30x200; 1x TX 40x200; 1x TX 45x200	
			Rack 2x 190,0x50,0	

### 467/7 TORX® HF Set 2 Screwdriver set T-handle TORX® screwdrivers with holding function

T-handle screwdriver: The ideal handle shape allows the transmission of particularly high tightening and loosening torque. The ergonomic shape of the handle fills the palm of the hand well, the fingers lie safely in the soft rounded handle recesses. The whole hand makes contact with the handle and friction losses between the hand and the handle are avoided.

With holding function to securely hold the TORX® screw on the tool. Special surface treatment of the blades for high corrosion protection and optimum fitting accuracy in the screw. Including metal rack for storage. The rack can be placed on the workbench or hung on the tool wall.

- Including metal rack; the rack can be placed upright or hung on the tool wall.

### 467/7 TORX® HF Set 2 Screwdriver set T-handle TORX® screwdrivers with holding function



Code	EAN			
05023456001	221728			1
			467 TORX® HF 1x TX 10x100; 1x TX 15x100; 1x TX 20x100; 1x TX 25x100; 1x TX 30x200; 1x TX 40x200; 1x TX 45x200	
			9606 1x 214,0x78,0	

### Bicycle set 6

10-piece T-handle screwdriver set for operations on the bike: The ideal handle shape allows the transmission of particularly high tightening and loosening moments. The ergonomic shape of the handle fills the ball of the hand well, the fingers lie securely in the softly rounded recessed grips.

The whole hand comes into contact with the handle and friction losses between hand and handle are avoided. With holding function at the long arm to hold the TORX® and hexagonal socket screws (from size 3) securely on the tool. Special surface treatment for high corrosion protection and optimal fitting accuracy in the screw.

With extra-short arm for the transmission of extremely high torques through the leverage of the long arm. Including metal rack for clearly arranged storage in the workshop.

- T-handle screwdriver for the transmission of particularly high tightening and loosening moments
- With holding function (HF) on the long arm to securely hold the screw on the tool
- With additional short arm for the transmission of extremely high torques due to the leverage of the long arm
- Take it easy tool finder: colour coding according to profile and size

### Bicycle set 6

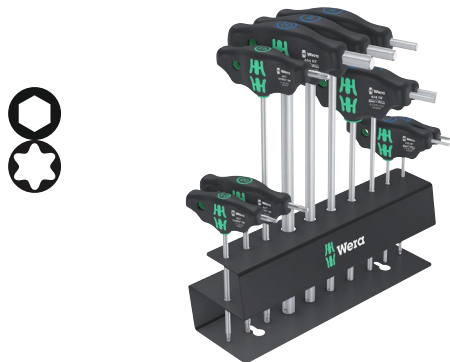

<b>Code</b>	<b>EAN</b>								
05004174001	220592								1
			<b>454</b>						
			1x 2,5x100						
			<b>454 HF</b>						
			1x 3x100; 1x 4x150; 1x 5x150; 1x 6x200;						
			1x 8x200; 1x 10x200						
			<b>467 TORX® HF</b>						
			1x TX 10x100; 1x TX 20x100; 1x TX 25x200						

### 9604 Metal rack for T-handle screwdrivers

Metal rack for T-handle screwdrivers. The rack can be placed on the workbench or hung on the tool wall.

For up to 7 Wera hexagonal socket T-handle screwdrivers.

- Metal rack for T-handle screwdrivers

### 9604 Metal rack for T-handle screwdrivers



	<b>EAN</b>								
<b>Code</b>	4013288	mm	mm						
05136424001	223418	214,0	78,0						1

### 9605 Metal rack for T-handle screwdrivers

Metal rack for T-handle screwdrivers. The rack can be placed on the workbench or hung on the tool wall.

For up to 10 Wera hexagonal socket T-handle screwdrivers.

- For up to 10 hexagonal socket T-handle screwdrivers

### 9605 Metal rack for T-handle screwdrivers



	<b>EAN</b>								
<b>Code</b>	4013288	mm	mm						
05136425001	223425	214,0	78,0						1

## 9606 Metal rack for T-handle screwdrivers

Metal rack for T-handle screwdrivers. The rack can be placed on the workbench or hung on the tool wall. For up to 7 Wera TORX® T-handle screwdrivers.

### 9606 Metal rack for T-handle screwdrivers



	EAN							
Code	4013288	mm	mm					
05136426001	223432	214,0	78,0					1

## ESD Series

ESD-safe Micro screwdriver. Dependable protection against electrostatic energy and associated damage. Rapid twisting results from fixing the hand on the head and using the fast-turning zone just below. This makes time-consuming grip adjustments unnecessary.

Power zones with integrated soft sections ensure the transfer of high loosening and tightening torque; a precision zone for the right rotation angle during fine adjustment work.

The Black Point tip offers optimised corrosion protection and an exact fit. Take it easy tool finder with colour coding according to profiles and size stamp – for simple and rapid accessing of the required tool.

- ESD-safe tool thanks to surface resistance of  $\leq 10^9$  Ohm
- Multi-component Kraftform Micro handle for fast and ergonomic screwdriving
- The Wera Black Point tip offers an exact fit and optimum corrosion protection
- Take it easy tool finder: colour coding according to profile and size
- Anti-roll feature and swivel cap for rapid twisting

## 1578 A ESD Kraftform Micro screwdriver for slotted screws



	EAN							
Code	4013288	mm	mm	mm	mm	mm	mm	
05030099001	215253	0,16	0,8	40	97	2,0	1/32"	5
05030101001	039040	0,23	1,5	40	97	2,0	1/16"	5
05030100001	039033	0,25	1,2	40	97	2,0	0,05"	5
05030102001	039057	0,30	1,8	60	97	2,0	0,07"	5
05030108001	194763	0,35	2,5	40	97	2,5	3/32"	5
05030103001	039064	0,40	2,0	60	97	2,5	5/64"	5
05030104001	039071	0,40	2,5	80	97	2,5	3/32"	5
05030105001	039088	0,50	3,0	80	97	3,0	1/8"	5
05030106001	039095	0,60	3,5	80	97	4,0	9/64"	5
05030107001	039101	0,80	4,0	80	97	4,0	5/32"	5

## 1550 PH ESD Kraftform Micro screwdriver for Phillips screws



	EAN						
Code	4013288	mm	mm	mm	mm	mm	
05030117001 <sup>1)</sup> 2)	194725	PH 000	40	97	1,5/2,5	1 9/16"	5
05030118001 <sup>1)</sup> 2)	194732	PH 00	40	97	1,8/2,5	1 9/16"	5
05030110001 <sup>2)</sup>	039118	PH 00	60	97	1,8/2,5	2 3/8"	5
05030119001 <sup>3)</sup>	194749	PH 0	40	97	3,0	1 9/16"	5
05030111001 <sup>3)</sup>	039125	PH 0	60	97	3,0	2 3/8"	5
05030112001	039132	PH 1	80	97	4,0	3 1/8"	5

<sup>1)</sup> Optimised for Asian PH screws

<sup>2)</sup> On the output side, the blade is turned to a nominal length of 10 mm

<sup>3)</sup> Size 0 modified according to JCS 0 (Japanese Camera Industrial Standard)

### 1550 PH S ESD Kraftform Micro screwdrivers



	EAN						
<b>Code</b>	4013288		mm	mm			
05030109001	215222	# 01	40	97	1 9/16"		5

### 1555 PZ ESD Kraftform Micro screwdriver for Pozidriv screws



	EAN						
<b>Code</b>	4013288		mm	mm	mm		
05030115001	039149	PZ 0	60	97	3,0	2 3/8"	5
05030116001	039156	PZ 1	80	97	4,0	3 1/8"	5

### TORX® Tools with holding function

Clamping force holds TORX® screw tight.

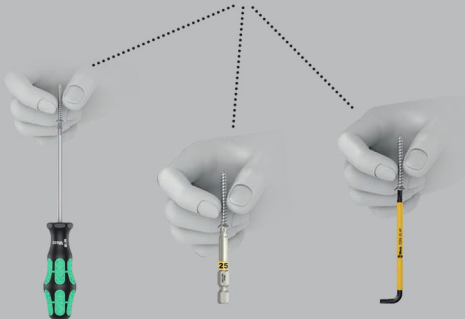

### 1567 TORX® HF ESD Kraftform Micro screwdriver with holding function for TORX® screws



	EAN						
<b>Code</b>	4013288		mm	mm	mm		
05030400001	183972	TX 4	40	97	2,5	1 9/16"	5
05030401001	183989	TX 5	40	97	3,0	1 9/16"	5
05030402001	183996	TX 6	40	97	3,0	1 9/16"	5
05030403001	184009	TX 7	60	97	3,0	2 3/8"	5
05030404001	184016	TX 8	60	97	3,0	2 3/8"	5
05030405001	184023	TX 9	60	97	4,0	2 3/8"	5
05030406001	184030	TX 10	60	97	4,0	2 3/8"	5

### 1567 TORX® ESD Kraftform Micro screwdriver for TORX® screws



	EAN						
<b>Code</b>	4013288		mm	mm	mm		
05030158001	215239	TX 2	40	97	2,0	1 9/16"	5
05030159001	215246	TX 3	40	97	2,0	1 9/16"	5
05030120001	039163	TX 4	40	97	2,5	1 9/16"	5
05030121001	039170	TX 5	40	97	3,0	1 9/16"	5
05030122001	039187	TX 6	40	97	3,0	1 9/16"	5

### 1567 TORX® BO ESD Kraftform Micro screwdriver for tamper-proof TORX® screws



	EAN						
<b>Code</b>	4013288		mm	mm	mm		
05030113001	219473	TX 6 BO	60	97	3,0	2 3/8"	5
05030114001	219480	TX 8 BO	60	97	3,0	2 3/8"	5

### 1567 IPR TORX PLUS® ESD Kraftform Micro screwdriver



	EAN						
<b>Code</b>	4013288		mm	mm	mm		
05030135001 <sup>1)</sup>	194756	1 IPR	40	97	2,0	1 9/16"	5

<sup>1)</sup>Without bore hole



### 1572 ESD Kraffform Micro screwdriver for Microstix® screws



	EAN						
<b>Code</b>	4013288		mm	mm	mm		
05030080001	181169	m	40	97	2,5	1 9/16"	5
05030081001	181176	00	40	97	2,5	1 9/16"	5
05030082001	181183	F	40	97	2,5	1 9/16"	5
05030083001	181190	0	40	97	2,5	1 9/16"	5
05030084001	181206	1	40	97	2,5	1 9/16"	5

### 1573 Pentalobe ESD Kraffform Micro screwdriver

- Kraffform Micro screwdriver for Pentalobe screws

### 1573 Pentalobe ESD Kraffform Micro screwdriver



	EAN						
<b>Code</b>	4013288		mm	mm	mm		
05030330001	219435	PL 1,1	40	97	2,0	1 9/16"	5
05030331001	219497	PL 1,4	40	97	2,0	1 9/16"	5

### 1569 ESD Nutdriver



	EAN						
<b>Code</b>	4013288		mm	mm	mm		
05030410001	184047	1,5	60	97	5,7	2 3/8"	5
05030411001	184054	1,8	60	97	5,7	2 3/8"	5
05030412001	184061	2,0	60	97	5,7	2 3/8"	5
05030413001	184078	2,5	60	97	5,7	2 3/8"	5
05030414001	184085	3,0	60	97	5,7	2 3/8"	5
05030415001	184092	3,2	60	97	5,7	2 3/8"	5
05030416001	184108	3,5	60	97	5,7	2 3/8"	5
05030417001	184115	4,0	60	97	5,7	2 3/8"	5
05030418001	184122	4,5	60	97	6,4	2 3/8"	5
05030150001	093486	5,0	60	97	7,0	2 3/8"	5
05030151001	093493	5,5	60	97	7,8	2 3/8"	5

### 1529 ESD Chip Removal Tool

- Chip lifter to remove firmly-fitted parts from a circuit board after desoldering

### 1529 ESD Chip Removal Tool



	EAN						
<b>Code</b>	4013288		mm	mm	mm	mm	
05027450001	219428	1,0	3,5	50	97		10

## Kraftform Micro ESD Big Pack 1 Screwdriver set for electronic applications

Electrostatically secured Wera Micro screwdriver 25-piece set. The included screw profiles are especially suitable for the use on mobile phones and tablets. Safe protection against electrostatic energy and associated damage.

By supporting the hand on the rotating cap, and by the fast rotating zone below the rotating cap, lightning fast turning is possible. Time-consuming hand switching is eliminated.

The power zone with integrated soft zones ensures the transmission of high tightening and loosening moments. Precision zone for correct rotation angles whilst adjusting.

The Black Point tip provides fitting accuracy and optimum corrosion protection.

Take it easy tool finder with size stamping and colour coding by profile to find the required tool quickly and easily. Storage and transport in a robust textile bag, so the tool is well protected and always close at hand.

- Included profiles especially suitable for servicing mobile phones, tablets and laptops/desktops
- Storage and transport in a robust textile bag, so the tool is well protected and always close at hand

## Kraftform Micro ESD Big Pack 1 Screwdriver set for electronic applications



Code	EAN		
05134019001	4013288 219459		1
		⊕ <b>1550 PH ESD Micro</b> 1x PH 000x40 <sup>1) 2)</sup> ; 1x PH 00x40 <sup>1) 2)</sup> ; 1x PH 0x40 <sup>3)</sup> ; 1x PH 1x80	
		⊕ <b>1550 PH S ESD Micro</b> 1x # 01x40	
		⊕ <b>1567 TORX® HF ESD Micro</b> 1x TX 8x60; 1x TX 10x60	
		⊕ <b>1567 TORX® ESD Micro</b> 1x TX 2x40; 1x TX 3x40; 1x TX 4x40; 1x TX 5x40; 1x TX 6x40	
		⊕ <b>1567 TORX® B0 ESD Micro</b> 1x TX 6 B0x60; 1x TX 8 B0x60	
		⊕ <b>1567 TORX PLUS® IPR ESD</b> 1x 1 IPRx40	
		⊕ <b>1572 ESD</b> 1x mx40; 1x 00x40; 1x Fx40; 1x 0x40	
		⊕ <b>1573 Pentalobe ESD</b> 1x PL 1,1x40; 1x PL 1,4x40	
		⊕ <b>1569 ESD</b> 1x 3,0x60	
		⊕ <b>1578 A ESD Micro</b> 1x 0,16x0,8x40; 1x 0,23x1,5x40	
		⊕ <b>1529 ESD</b> 1x 1,0x3,5x50	

<sup>1)</sup> Optimised for Asian PH screws

<sup>2)</sup> On the output side, the blade is turned to a nominal length of 10 mm

<sup>3)</sup> Size 0 modified according to JCIS 0 (Japanese Camera Industrial Standard)

### 1578 A/6 ESD Screwdriver set and rack for electronic applications

- Includes practical rack for tidy storage of the screwdrivers

#### 1578 A/6 ESD Screwdriver set and rack for electronic applications



Code		EAN			
05030170001		4013288	113900		1
		+	1550 PH ESD Micro		
			1x PH 0x60 <sup>1)</sup> ; 1x PH 1x80		
		-	1578 A ESD Micro		
			1x 0,23x1,5x40; 1x 0,25x1,2x40; 1x 0,30x1,8x60; 1x 0,40x2,5x80		

<sup>1)</sup> Size 0 modified according to JCIS 0 (Japanese Camera Industrial Standard)

### 1550/6 ESD Screwdriver set and rack for electronic applications

- Includes practical rack for tidy storage of the screwdrivers

#### 1550/6 ESD Screwdriver set and rack for electronic applications



Code		EAN			
05030180001		4013288	194787		1
		+	1550 PH ESD Micro		
			1x PH 000x40 <sup>1) 2)</sup> ; 1x PH 00x40 <sup>1) 2)</sup> ; 1x PH 0x40 <sup>3)</sup>		
		-	1578 A ESD Micro		
			1x 0,35x2,5x40		
		T	1567 TORX PLUS® IPR ESD		
			1x 1 IPRx40		
		E	1572 ESD		
			1x mx40		

<sup>1)</sup> Optimised for Asian PH screws

<sup>2)</sup> On the output side, the blade is turned to a nominal length of 10 mm

<sup>3)</sup> Size 0 modified according to JCIS 0 (Japanese Camera Industrial Standard)

### 1013 Kraffform Micro ESD bitholding screwdriver

ESD-safe Wera tool. The Kraffform Micro ESD holder for dependable protection against electrostatic energy and associated damage. Electrical surface resistance of  $\leq 10^9$  Ohm. Ergonomic Kraffform handle for pleasant and low-fatigue working.

Black anti-roll feature prevents any bothersome rolling away at the workplace. Suitable for the take-up of bits with 4 mm half-moon drive and bits with 4 mm HIOS drive. Ideal for applications on smartphones, cell phones, cameras, electrical appliances, in dental labs and dental surgeries.

- Kraffform Micro ESD bit holder
- ESD-safe tool thanks to surface resistance of  $\leq 10^9$  Ohm
- Multi-component Kraffform Micro handle with anti-roll feature and swivel cap
- Suitable for take-up of bits with 4 mm halfmoon drive and bits with 4 mm HIOS drive
- Applications e.g. on smartphones, mobile phones, cameras, electronic equipment

#### 1013 Kraffform Micro ESD Bitholding screwdriver



	EAN	□	□	□					
Code	4013288	mm	mm						1
05300004001	168610	23	97	29/32"					

## Radidaptor - the amazing compact multifunction tool

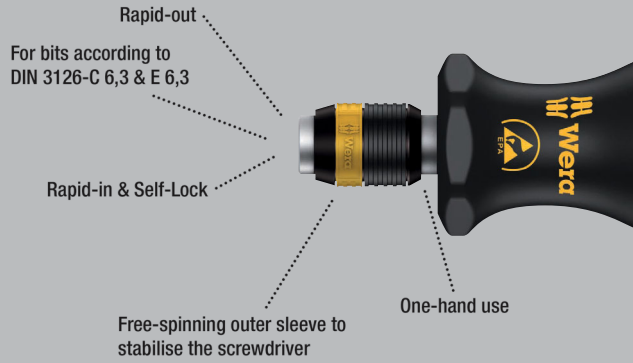

- ESD bit holder for ESD-safe working
- Surface resistance of  $\leq 10^9$  Ohm
- Multi-component Kraftform handle for fast and ergonomic screwdriving
- Hexagonal anti-roll feature against rolling away
- 1/4" hexagon take-up with Radidaptor quick-release chuck

### 816 R ESD Bitholding screwdriver, non-magnetic



	EAN							
Code	4013288		mm					
05051464001	103918	1/4"	119					2

### 813 R ESD Bitholding screwdriver, non-magnetic



	EAN							
Code	4013288		mm					
05051273001	103901	1/4"	90					2

## Kraftform Kompakt 60 ESD

ESD-safe Wera tool. 16 bits. Includes bitholder 816 R ESD holder, multi-component for high working speeds and particularly ergonomic screwdriving. Dependable protection against electrostatic energy and associated damage.

Compact set that enables both manual as well as power tool operations. Simple sorting according to profile and size, easy bit removal and reinsertion; with belt clip, 18-piece.

- Suitable for manual and power tool operations
- Smooth hard zones for high speed turning, soft grip zones for high torque transfer
- Radidaptor quick-release chuck
- Tough viscous bits for universal use
- In robust pouch

### Kraftform Kompakt 60 ESD



	Code	EAN						
	05051043001	4013288 183934						1
			<b>816 R ESD</b> 1x 1/4"x119					
			<b>851/4 Z PH</b> 1x PH 1x89; 1x PH 2x89; 1x PH 3x89					
			<b>855/4 Z PZ</b> 1x PZ 1x89; 1x PZ 2x89; 1x PZ 3x89					
			<b>867/4 Z TORX® B0</b> 1x TX 10x89; 1x TX 15x89; 1x TX 20x89; 1x TX 25x89; 1x TX 30x89					
			<b>840/4 Z Hex-Plus</b> 1x 3,0x89; 1x 4,0x89; 1x 5,0x89; 1x 6,0x89					
			<b>800/4 Z</b> 1x 1,0x5,5x89					

## Kraftform Kompakt Micro 21 ESD 1

Kraftform Kompakt Micro set for precision mechanical work. Suitable for the take-up of bits with 4 mm halfmoon drive (Wera series 9) and bits with 4 mm HIOS drive (Wera series 21). Electrical surface resistance of  $\leq 10^9$  Ohm for secure protection against electrostatic charge.

Manufactured in accordance with DIN EN 61340-5-1. Compact handle/interchangeable blade system for fast blade change. Kraftform Micro handle with twist cap and free-turning zone for rapid twisting, making any time-consuming repositioning of the fingers unnecessary.

Power zone with integrated soft zones for the transfer of higher tightening and loosening torque. Precision zone directly above the blade for the right angle for adjustment work. Bits for manual as well as power tool operations. Rapid fixing of the bit: just push the bit into the insert for automatic locking and a secure fit. To change the bit, simply push the sleeve forward and remove. Free-turning sleeve for simple guidance of the tool during the screwdriving process.

## Kraftform Kompakt Micro 21 ESD 1



Code	EAN		
05135973001	194855		1
		<b>1013 Kraftform Micro ESD</b> 1x 97	
		<b>851/9 C</b> 1x PH 000x44 <sup>1)</sup> ; 1x PH 00x44 <sup>1)</sup> ; 1x PH 0x44 <sup>2)</sup>	
		<b>867/9 C TORX®</b> 1x TX 1x44; 1x TX 2x44; 1x TX 3x44; 1x TX 4x44; 1x TX 5x44	
		<b>867/9 C TORX PLUS®</b> 1x 1 IPx44; 1x 2 IPx44; 1x 3 IPx44; 1x 4 IPx44	
		<b>867/9 IPR TORX® PLUS</b> 1x 1 IPRx44	
		<b>872/9</b> 1x mx44; 1x 00x44; 1x Fx44; 1x 0x44	
		<b>800/9 C</b> 1x 0,23x1,5x44; 1x 0,35x2,5x44	
		<b>869/9</b> 1x 2,5x44,0	

<sup>1)</sup> Optimised for Asian PH screws

<sup>2)</sup> Size 0 modified according to JCS 0 (Japanese Camera Industrial Standard)

## Kraftform Kompakt Micro 20 ESD 1

- Bit holder suitable for the take-up of bits with 4 mm halfmoon or HIOS drive
- Handle out of material with a surface resistance of  $\leq 10^9$  Ohm
- Handle/Interchangeable blade system for rapid exchange of the blade
- Kraftform Micro handle with swivel cap for rapid twisting
- Bits for manual as well as power tool operations

## Kraftform Kompakt Micro 20 ESD 1



Code	EAN		
05073671001	169662		1
		<b>1013 Kraftform Micro ESD</b> 1x 97	
		<b>851/9 C</b> 1x PH 000x44 <sup>1)</sup> ; 1x PH 0x44 <sup>2)</sup> ; 1x PH 1x44 <sup>1)</sup>	
		<b>867/9 C TORX®</b> 1x TX 1x44; 1x TX 2x44; 1x TX 3x44; 1x TX 4x44; 1x TX 5x44; 1x TX 6x44	
		<b>867/9 C TORX PLUS®</b> 1x 1 IPx44; 1x 2 IPx44; 1x 3 IPx44; 1x 4 IPx44	
		<b>840/9 C</b> 1x 1,5x44; 1x 2,0x44	
		<b>800/9 C</b> 1x 0,23x1,5x44; 1x 0,40x2,0x44; 1x 0,50x3,0x44	
		<b>867/9 IPR TORX® PLUS</b> 1x 1 IPRx44	

<sup>1)</sup> Optimised for Asian PH screws

<sup>2)</sup> Size 0 modified according to JCS 0 (Japanese Camera Industrial Standard)

### Kraftform Kompakt Micro 11 ESD 1



Code		EAN		
		4013288		
05073670001	168344			1
		1013 Kraftform Micro ESD		
		1x 97		
		851/9 C		
		1x PH 00x44 <sup>1)</sup> ; 1x PH 0x44 <sup>2)</sup> ; 1x PH 1x44 <sup>1)</sup>		
		867/9 C TORX®		
		1x TX 5x44; 1x TX 6x44		
		800/9 C		
		1x 0,23x1,5x44; 1x 0,40x2,0x44;		
		1x 0,50x3,0x44		
		840/9 C		
		1x 1,5x44; 1x 2,0x44		

<sup>1)</sup> Optimised for Asian PH screws

<sup>2)</sup> Size 0 modified according to JCIS 0 (Japanese Camera Industrial Standard)

### Kraftform Kompakt Stubby ESD 1

Handle/interchangeable blade system for lightning fast replacement of the required blade. Especially small ESD bit-holding Stubby screwdriver handle with short blade for electrostatically secure working even in hard to reach areas.

Suitable for the mounting of bits with 1/4" hexagon drive as per DIN ISO 1173-C 6.3 and Wera connection series 1. With strong permanent magnet, which also holds large and heavy screws.

The 2-component Kraftform handle with its practical combination of hard and soft zones allows for a firm grip and precise working. High-quality bits for universal use. Compact, textile box with high robustness, low weight and volume. Suitable for docking with the Wera 2go system.

- ESD bits hand holder for electrostatically safe working, magnetic
- 851/1 J: bits optimized for Asian PH screws

### Kraftform Kompakt Stubby ESD 1



Code		EAN		
		4013288		
05057472001	214584			1
		811/1 Stubby ESD		
		1x 1/4"x54		
		851/1 Z PH		
		1x PH 0x25; 1x PH 1x25; 1x PH 2x25		
		851/1 J		
		1x PH 00x25x2,0 <sup>1)</sup>		
		800/1 Z		
		1x 0,5x3,0x25; 1x 0,6x4,5x25; 1x 1,0x5,5x25;		
		1x 1,2x6,5x25; 1x 1,2x8,0x25		

<sup>1)</sup> Size 00 modified according to JCIS 00 (Japanese Camera Industrial Standard)

### 809/1 ESD Stubby Bitholding screwdriver, with retaining ring

- Short compact shape for working in confined spaces
- Bit holder with retaining ring for bits with 1/4" hexagon drive

#### 809/1 ESD Stubby Bitholding screwdriver, with retaining ring



	EAN						
Code	4013288		mm	mm			
05008882001	219206	1/4"	10	54	3/8"		2

### 811/1 ESD Stubby Bitholding screwdriver, magnetic

- Short compact shape for working in confined spaces
- Ergonomic 2-component Kraftform handle for precise work
- Hexagonal anti-roll feature against rolling away
- ESD bits hand holder for electrostatically safe working, magnetic
- For 1/4" bits as per DIN ISO 1173-C 6.3

#### 811/1 ESD Stubby Bitholding screwdriver, magnetic



	EAN						
Code			mm	mm			
05008881001	212382	1/4"	10	54	3/8"		2

### 9514 ESD Magnetiser SB

Magnetiser. Simply pull the tool along the positive side of the Wera magnetiser and the tool will hold the screw securely on the blade.

To demagnetise, move the tool along the negative side.

- Magnetiser
- ESD-safe tool thanks to surface resistance of  $\leq 10^9$  Ohm
- To magnetise and demagnetise tool tips
- Securely holds the screw on the tool

#### 9514 ESD Magnetiser SB



	EAN						
Code	4013288	mm					
05073984001	225924	64,6					1

## Kraftform Stainless - stainless steel to prevent rust

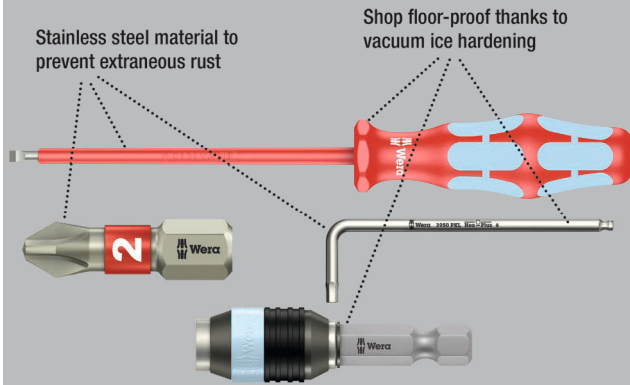

High quality Kraftform Plus VDE screwdriver out of stainless steel by Wera. The stainless tools from Wera are vacuum ice-hardened and have the hardness and strength needed for screw connections. They can be used for industrial application without hesitation.

The individual testing of the Kraftform Stainless VDE screwdrivers at 10,000 volts as per DIN EN 60900 (IEC 60900) ensures safe working with voltages of up to 1,000 volts. Secure working is also ensured under extreme conditions and verified with the proven cold impact resistance at -40° C. Kraftform handle for fast and low-fatigue working.

Take it easy Tool Finder: colour coding according to profile and size. The hexagonal anti-roll feature prevents any bothersome rolling away at the workplace.

## Lasertip - laser engineered blade

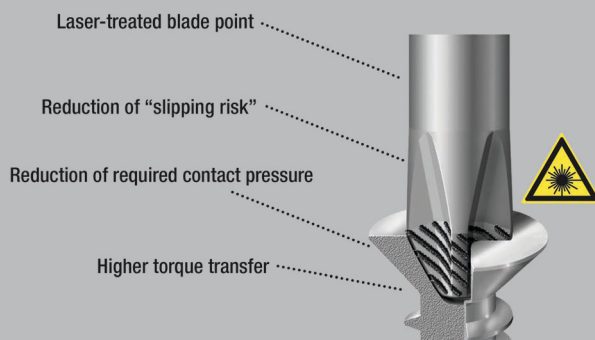

### 3160 i VDE Insulated Screwdriver for slotted screws, stainless



	EAN								
Code	4013288	mm	mm	mm	mm				
05022729001 <sup>1)</sup>	122353	0,5	3,0	80	81	1/8"	3 1/8"		10
05022730001 <sup>1)</sup>	122148	0,6	3,5	100	81	9/64"	4"		10
05022731001	122155	0,8	4,0	100	98	5/32"	4"		10
05022732001	122162	1,0	5,5	125	98	7/32"	5"		10

<sup>1)</sup> without Lasertip

### 3162 i PH VDE Insulated Screwdriver for Phillips screws, stainless



	EAN								
Code	4013288		mm	mm					
05022733001	122179	PH 1	80	98	3 1/8"				5
05022734001	122186	PH 2	100	105	4"				5

### 3165 i PZ VDE Insulated Screwdriver for Pozidriv screws, stainless



	EAN								
Code	4013288		mm	mm					
05022740001	183941	PZ 1	80	98	3 1/8"				5
05022741001	183965	PZ 2	100	105	4"				5



### 3167 i VDE-isolated TORX® screwdriver, stainless steel



Code	EAN					
05022760001	220103	TX 8	80	81	3 1/8"	5
05022761001	220110	TX 9	80	81	3 1/8"	5
05022762001	220127	TX 10	80	81	3 1/8"	5
05022763001	220134	TX 15	80	98	3 1/8"	5
05022764001	220141	TX 20	80	98	3 1/8"	5
05022765001	220158	TX 25	100	105	4"	5
05022766001	220165	TX 30	100	105	4"	5

### 3160 i/7 Screwdriver set, stainless and rack

- Including useful rack for well-arranged storage of the screwdrivers

### 3160 i/7 Screwdriver set, stainless and rack



Code	EAN			
05022728001	118073			1
			<b>3162 i VDE</b> 1x PH 1x80; 1x PH 2x100	
			<b>3160 i VDE</b> 1x 0,5x3,0x80 <sup>1)</sup> ; 1x 0,6x3,5x100 <sup>1)</sup> ; 1x 0,8x4,0x100; 1x 1,0x5,5x125	
			<b>3247</b> 1x 0,5x3,0x70	

<sup>1)</sup> without Lasertip

<sup>2)</sup> Product not available in the USA and Canada.

### 3165 i/6 Screwdriver set, stainless and rack

- Including useful rack for well-arranged storage of the screwdrivers

### 3165 i/6 Screwdriver set, stainless and rack



Code	EAN			
05022745001	184207			1
			<b>3165 i PZ VDE</b> 1x PZ 1x80; 1x PZ 2x100	
			<b>3160 i VDE</b> 1x 0,5x3,0x80 <sup>1)</sup> ; 1x 0,6x3,5x100 <sup>1)</sup> ; 1x 0,8x4,0x100; 1x 1,0x5,5x125	

<sup>1)</sup> without Lasertip

### 3167 i/7 TORX® Screwdriver set, stainless and rack

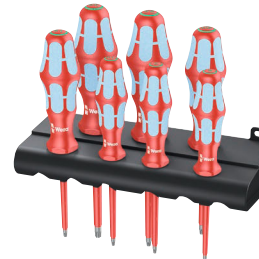

Code	EAN		
05022767001	220172		1
			<b>3167 i TORX® VDE</b> 1x TX 8x80; 1x TX 9x80; 1x TX 10x80; 1x TX 15x80; 1x TX 20x80; 1x TX 25x100; 1x TX 30x100

## Lasertip - laser engineered blade

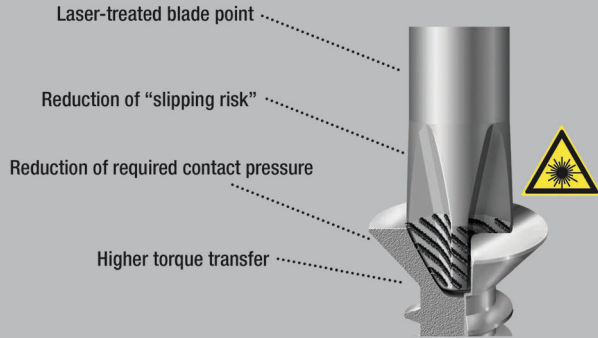

Wera VDE screwdrivers with multi-component Kraftform Plus handle for fast and low-fatigue working: hard gripping zones for high working speeds whereas soft zones ensure high torque transfer. Individually tested at 10,000 volts for secure work at the permissible voltage of 1,000 volts.

The tips of the Wera Lasertip screwdrivers are microscopically roughened by laser beams. This rough surface literally bites into the head of the screw. Any unintentional slipping out is therefore a thing of the past.

Take it easy tool finder with colour coding according to profiles and size stamp – for simple and rapid accessing of the required tool. The hexagonal anti-roll feature prevents any bothersome rolling away at the workplace.

- Insulated blades for secure work at 1,000 volts
- Smooth hard zones for high speed turning, soft grip zones for high torque transfer
- Take it easy tool finder: colour coding according to profile and size
- Hexagonal anti-roll feature against rolling away
- Conical blade, Lasertip

### 160 i VDE Insulated screwdriver for slotted screws

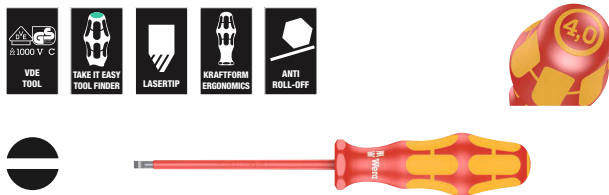

Code	EAN	mm	mm	mm	mm	mm	mm	
05006100001 <sup>1)</sup>	027221	0,4	2,5	80	81	3/32"	3 1/8"	10
05006105001 <sup>1)</sup>	027238	0,5	3,0	100	81	1/8"	4"	10
05006110001 <sup>1)</sup>	027245	0,6	3,5	100	81	9/64"	4"	10
05006115001	027252	0,8	4,0	100	98	5/32"	4"	10
05006116001	105431	0,8	4,0	150	98	5/32"	6"	5
05006120001	027269	1,0	5,5	125	98	7/32"	5"	10
05006121001	105448	1,0	5,5	200	98	7/32"	8"	5
05006125001	027276	1,2	6,5	150	105	1/4"	6"	10
05006126001	105455	1,2	6,5	200	105	1/4"	8"	5
05006130001	027283	1,2	8,0	175	112	5/16"	7"	5
05006135001	028884	1,6	8,0	200	112	5/16"	8"	5
05006140001	028877	1,6	10,0	200	112	3/8"	8"	5

<sup>1)</sup>without Lasertip

### 160 i SB VDE Insulated screwdriver for slotted screws



Code	EAN		
05100000001	181466	160 i VDE	1x 0.4x2.5x80 <sup>1)</sup>
05100001001	181473	160 i VDE	1x 0.5x3.0x100 <sup>1)</sup>
05100002001	181480	160 i VDE	1x 0.6x3.5x100 <sup>1)</sup>
05100003001	181497	160 i VDE	1x 0.8x4.0x100
05100004001	181503	160 i VDE	1x 1.0x5.5x125

<sup>1)</sup>without Lasertip

### 160 iS VDE Insulated screwdriver with reduced blade diameter for slotted screws

- Reduced shaft diameter
- Allows screwdriving even in confined situations
- Low-lying screw and spring elements can be reached and actuated

### 160 iS VDE Insulated screwdriver with reduced blade diameter for slotted screws



Code	EAN	mm	mm	mm	mm	mm	mm	
05006440001	160089	0,6	3,5	100	81	9/64"	4"	10
05006441001	160102	0,8	4,0	100	98	5/32"	4"	10
05006442001	160126	1,0	5,5	125	98	7/32"	5"	10

### 160 iSS VDE Insulated screwdriver with reduced blade and handle diameter for slotted screws

- Reduced blade and handle diameter
- Allows screwdriving even in confined situations
- Low-lying screw and spring elements can be reached and actuated

### 160 iSS VDE Insulated screwdriver with reduced blade and handle diameter for slotted screws



Code	EAN	mm	mm	mm	mm	mm	mm	
05020129001	179548	0,8	4,0	100	81	5/32"	4"	5

### 162 i PH VDE Insulated screwdriver for Phillips screws



Code	EAN	+	mm	mm	mm		
05006150001 <sup>1)</sup>	027290	PH 0	80	81	3 1/8"		5
05006152001	027306	PH 1	80	98	3 1/8"		5
05006153001	105417	PH 1	150	98	6"		5
05006154001	027313	PH 2	100	105	4"		5
05006159001	105424	PH 2	200	105	8"		5
05006156001	027320	PH 3	150	112	6"		5
05006158001 <sup>1)</sup>	027818	PH 4	200	112	8"		2

<sup>1)</sup>without Lasertip

### 162 i PH SB VDE Insulated screwdriver for Phillips screws



Code	EAN	+		
05100011001	181442	+	162 i PH VDE 1x PH 1x80	5
05100012001	181459	+	162 i PH VDE 1x PH 2x100	5

### 162 iS PH VDE Insulated screwdriver with reduced blade diameter for Phillips screws

- Reduced shaft diameter
- Allows screwdriving even in confined situations
- Low-lying screw and spring elements can be reached and actuated

### 162 iS PH VDE Insulated screwdriver with reduced blade diameter for Phillips screws



Code	EAN	+	mm	mm	mm		
05006450001	160140	PH 1	80	98	3 1/8"		5
05006451001	160164	PH 2	100	105	4"		5

### 162 iSS PH VDE Insulated screwdriver with reduced blade diameter for Phillips screws

- Reduced blade and handle diameter
- Allows screwdriving even in confined situations
- Low-lying screw and spring elements can be reached and actuated



### 162 iSS PH VDE Insulated screwdriver with reduced blade diameter for Phillips screws



Code	EAN	+	mm	mm	mm		
05020131001	179432	PH 1	80	81	3 1/8"		5
05020133001	179425	PH 2	100	98	4"		5

### 165 i PZ VDE Insulated screwdriver for Pozidriv screws



Code	EAN	+	mm	mm	mm		
05006160001 <sup>1)</sup>	032782	PZ 0	80	81	3 1/8"		5
05006162001	029836	PZ 1	80	98	3 1/8"		5
05006163001	105462	PZ 1	150	98	6"		5
05006164001	029843	PZ 2	100	105	4"		5
05006165001	105479	PZ 2	200	105	8"		5
05006166001	029850	PZ 3	150	112	6"		5
05006168001 <sup>1)</sup>	029867	PZ 4	200	112	8"		2

<sup>1)</sup>without Lasertip

### 165 i PZ SB VDE Insulated screwdriver for Pozidriv screws

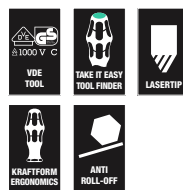

Code	EAN	+		
05100015001	181510	+	165 i PZ VDE 1x PZ 1x80	5
05100016001	181527	+	165 i PZ VDE 1x PZ 2x100	5

**165 iS PZ VDE Insulated screwdriver with reduced blade diameter for Pozidriv screws**

- Reduced shaft diameter
- Allows screwdriving even in confined situations
- Low-lying screw and spring elements can be reached and actuated

**165 iS PZ VDE Insulated screwdriver with reduced blade diameter for Pozidriv screws**

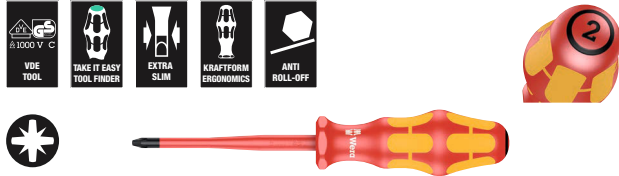

	EAN						
<b>Code</b>	4013288		mm	mm			
05006460001	160188	PZ 1	80	98	3 1/8"		5
05006461001	160249	PZ 2	100	105	4"		5

**162 i PH/S VDE Insulated screwdriver for PlusMinus screws (Phillips/slotted)**

- Combination profile Phillips/slotted

**162 i PH/S VDE Insulated screwdriver for PlusMinus screws (Phillips/slotted)**



	EAN						
<b>Code</b>	4013288		mm	mm			
05006380001	102614	# 1	80	98	3 1/8"		5
05006381001	102621	# 2	100	105	4"		5

**162 i PH/S SB VDE Insulated screwdriver for PlusMinus screws (Phillips/slotted)**



	EAN					
<b>Code</b>	4013288					
05100019001	186560		162 i PH/S VDE	1x # 1x80		5
05100020001	186577		162 i PH/S VDE	1x # 2x100		5

**162 iS PH/S VDE Insulated screwdriver with reduced blade diameter for PlusMinus screws (Phillips/slotted)**

- Reduced shaft diameter: combination profile Phillips/slotted
- Allows screwdriving even in confined situations
- Low-lying screw and spring elements can be reached and actuated

**162 iS PH/S VDE Insulated screwdriver with reduced blade diameter for PlusMinus screws (Phillips/slotted)**

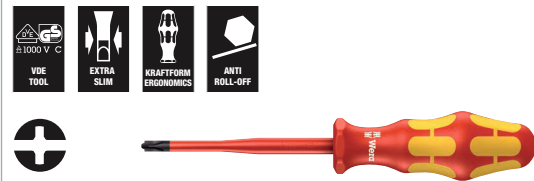

	EAN						
<b>Code</b>	4013288		mm	mm			
05006455001	160201	# 1	80	98	3 1/8"		5
05006456001	160225	# 2	100	105	4"		5

**165 i PZ/S VDE Insulated screwdriver for PlusMinus screws (Pozidriv/slotted)**

- Combination profile Pozidriv/slotted

**165 i PZ/S VDE Insulated screwdriver for PlusMinus screws (Pozidriv/slotted)**



	EAN						
<b>Code</b>	4013288		mm	mm			
05006190001	102638	# 1	80	98	3 1/8"		5
05006191001	102645	# 2	100	105	4"		5

**165 i PZ/S SB VDE Insulated screwdriver for PlusMinus screws (Pozidriv/slotted)**

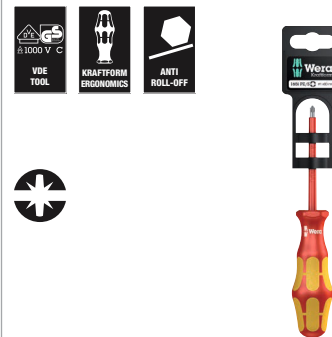

	EAN					
<b>Code</b>	4013288					
05100021001	186584		165 i PZ/S VDE	1x # 1x80		5
05100022001	186591		165 i PZ/S VDE	1x # 2x100		5

**165 iS PZ/S VDE Insulated screwdriver with reduced blade diameter for PlusMinus screws (Pozidriv/slotted)**

- Reduced shaft diameter: combination profile Pozidriv/slotted
- Allows screwdriving even in confined situations
- Low-lying screw and spring elements can be reached and actuated



Code	EAN		mm	mm	mm		
05006465001	160263	# 1	80	98	3 1/8"		5
05006466001	160287	# 2	100	105	4"		5

**165 iSS PZ/S VDE Insulated screwdriver with reduced blade diameter for PlusMinus screws (Pozidriv/slotted)**

- Reduced blade and handle diameter
- Allows screwdriving even in confined situations
- Low-lying screw and spring elements can be reached and actuated



Code	EAN		mm	mm	mm		
05020132001	179418	# 1	80	81	3 1/8"		5
05020134001	179401	# 2	100	98	4"		5

**167 i VDE Insulated screwdriver for TORX® screws**



Code	EAN		mm	mm	mm		
05006181001	108876	TX 5	80	81	3 1/8"		5
05006182001	108883	TX 6	80	81	3 1/8"		5
05006183001	108890	TX 7	80	81	3 1/8"		5
05006184001	108906	TX 8	80	81	3 1/8"		5
05006169001	036452	TX 9	80	81	3 1/8"		5
05006170001	036667	TX 10	80	81	3 1/8"		5
05006172001	036674	TX 15	80	98	3 1/8"		5
05006174001	036681	TX 20	80	98	3 1/8"		5
05006176001	036698	TX 25	100	105	4"		5
05006177001	036469	TX 27	100	105	4"		5
05006178001	036704	TX 30	100	105	4"		5
05006179001	036476	TX 40	150	112	6"		5

**168 i VDE Insulated screwdriver for square socket head screws**



Code	EAN		mm	mm	mm		
05004780001	038777	# 1	80	98	3 1/8"		5
05004783001	105486	# 1	150	98	6"		5
05004781001	038784	# 2	100	105	4"		5
05004784001	105493	# 2	200	105	8"		5
05004782001	040909	# 3	150	112	6"		5

**168 i SB VDE Insulated screwdriver for square socket head screws**



Code	EAN			
05100024001	181534	○	168 i VDE 1x # 1x80	5
05100025001	181541	○	168 i VDE 1x # 2x100	5
05100026001	181558	○	168 i VDE 1x # 3x150	5

### 190 i VDE Insulated nutdriver



	EAN							
Code	4013288	mm		mm	mm	mm		
05005300001	032485	5,5		125	98	11,0	5"	5
05005305001	032492	6,0		125	98	12,0	5"	5
05005310001	032508	7,0		125	105	14,0	5"	5
05005315001	032515	8,0		125	105	15,0	5"	5
05005320001	032522	9,0		125	105	16,0	5"	5
05005325001	032539	10,0		125	112	17,0	5"	5
05005330001	032546	11,0		125	112	19,0	5"	5
05005335001	032553	12,0		125	112	20,0	5"	5
05005340001	032560	13,0		125	112	21,0	5"	5

### 247 Single-pole phase tester



	EAN							
Code	4013288	mm	mm	mm	mm			
05005655001	002686	0,5	3,0	70	3,0	1/8"	2 3/4"	5

<sup>1)</sup>Product not available in the USA and Canada.

### 247 SB Single-pole phase tester



	EAN			
Code	4013288			
05100100001	181664		247 1x 0.5x3.0x70	5

<sup>1)</sup>Product not available in the USA and Canada.

### Kraftform Big Pack 100 VDE

14-piece screwdriver set with individually tested, insulated screwdrivers as per IEC 60900. Individual testing at 10,000 volts so as to ensure safe working at the permitted voltage of 1,000 volts.

- Insulated blades for secure work at 1,000 volts
- Multi-component Kraftform handle for high working speeds and ergonomic screwdriving
- Take it easy tool finder: colour coding according to profile and size
- Hexagonal anti-roll feature against rolling away
- Lasertip tips for more secure fit in the screw head

### Kraftform Big Pack 100 VDE

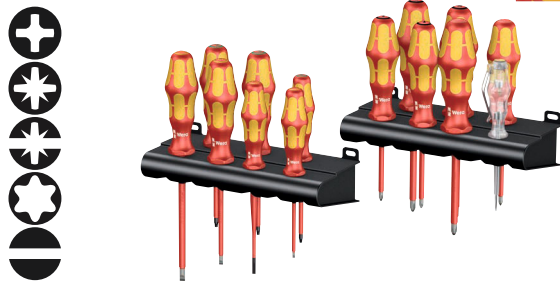

Code	EAN		
05105631001	163639		1
		<b>162 i PH VDE</b> 1x PH 1x80; 1x PH 2x100	
		<b>165 i PZ VDE</b> 1x PZ 1x80; 1x PZ 2x100	
		<b>165 i PZ/S VDE</b> 1x # 1x80; 1x # 2x100	
		<b>167 i TORX® VDE</b> 1x TX 10x80; 1x TX 15x80; 1x TX 20x80	
		<b>160 iS</b> 1x 0,6x3,5x100	
		<b>160 i VDE</b> 1x 0,4x2,5x80 <sup>1)</sup> ; 1x 0,8x4,0x100; 1x 1,0x5,5x125	
		<b>247</b> 1x 0,5x3,0x70	
		<b>Rack</b> 2x 190,0x50,0	

<sup>1)</sup> without Lasertip

<sup>1)</sup>Product not available in the USA and Canada.

## Kraftform 2go 100

11 VDE-insulated, Kraftform screwdrivers; with Take it easy Toolfinder; in the Wera 2go 4 quiver; comes with an adjustable partition element for individual sectioning.

- Suitable for docking with the Wera 2go system

### Kraftform 2go 100

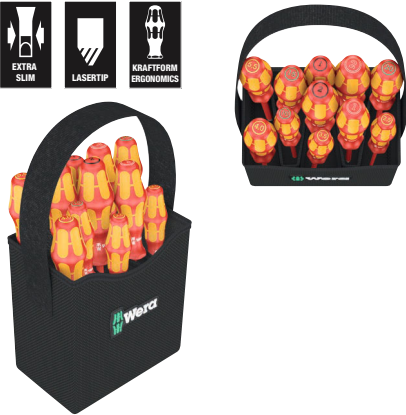

Code	EAN		
05004310001	187826		1
		Wera 2go 4 1x 165,0x165,0x105,0	
		⊕ 162 i PH VDE 1x PH 1x80; 1x PH 2x100	
		⊕ 165 i PZ VDE 1x PZ 1x80; 1x PZ 2x100	
		⊕ 167 i TORX® VDE 1x TX 10x80; 1x TX 15x80; 1x TX 20x80	
		● 160 i VDE 1x 0,4x2,5x80 <sup>1)</sup> ; 1x 0,8x4,0x150; 1x 1,0x5,5x200	
		● 160 iS 1x 0,6x3,5x100	
		K120 1x 50,0x120,0	

<sup>1)</sup>without Lasertip

## 160 i/6 Rack Screwdriver set Kraftform Plus Series 100 + Rack

- Including useful rack for well-arranged storage of the screwdrivers

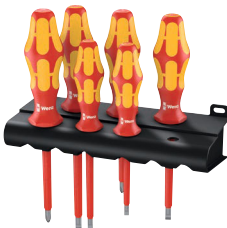

Code	EAN		
05006145001	027887		1
		⊕ 162 i PH VDE 1x PH 1x80; 1x PH 2x100	
		● 160 i VDE 1x 0,4x2,5x80 <sup>1)</sup> ; 1x 0,6x3,5x100 <sup>1)</sup> ; 1x 0,8x4,0x100; 1x 1,0x5,5x125	

<sup>1)</sup>without Lasertip

## 160 i/7 Rack Screwdriver set Kraftform Plus Series 100, single-pole phase tester and rack

- Including useful rack for well-arranged storage of the screwdrivers



Code	EAN		
05006147001	041708		1
		⊕ 162 i PH VDE 1x PH 1x80; 1x PH 2x100	
		● 160 i VDE 1x 0,4x2,5x80 <sup>1)</sup> ; 1x 0,6x3,5x100 <sup>1)</sup> ; 1x 0,8x4,0x100; 1x 1,0x5,5x125	
		● 247 1x 0,5x3,0x70	

<sup>1)</sup>without Lasertip

<sup>2)</sup>Product not available in the USA and Canada.

## 160 i/165 i/7 Rack Screwdriver set Kraftform Plus Series 100, single-pole phase tester and rack

- Including useful rack for well-arranged storage of the screwdrivers

## 160 i/165 i/7 Rack Screwdriver set Kraftform Plus Series 100, single-pole phase tester and rack



Code	EAN		
05006148001	041715		1
		⊕ 165 i PZ VDE 1x PZ 1x80; 1x PZ 2x100	
		● 160 i VDE 1x 0,4x2,5x80 <sup>1)</sup> ; 1x 0,6x3,5x100 <sup>1)</sup> ; 1x 0,8x4,0x100; 1x 1,0x5,5x125	
		● 247 1x 0,5x3,0x70	

<sup>1)</sup>without Lasertip

<sup>2)</sup>Product not available in the USA and Canada.

**167 i/6 Screwdriver set Kraftform Plus Series 100**



Code	EAN		
05133356001	4013288 160072		1
		167 i TORX® VDE 1x TX 8x80; 1x TX 9x80; 1x TX 10x80; 1x TX 15x80; 1x TX 20x80; 1x TX 25x100	

**160 iS/7 Rack Screwdriver set Kraftform Plus Series 100, single-pole phase tester and rack. With reduced blade diameter.**

- Reduced shaft diameter
- Allows screwdriving even in confined situations
- Low-lying screw and spring elements can be reached and actuated
- Including useful rack for well-arranged storage of the screwdrivers

**160 iS/7 Rack Screwdriver set Kraftform Plus Series 100, single-pole phase tester and rack. With reduced blade diameter**



Code	EAN		
05006480001	4013288 160713		1
		162 iS 1x PH 1x80; 1x PH 2x100	
		165 iS PZ/S 1x # 2x100	
		160 iS 1x 0,6x3,5x100; 1x 0,8x4,0x100; 1x 1,0x5,5x125	
		247 1x 0,5x3,0x70	

<sup>1)</sup>Product not available in the USA and Canada.

**160 iSS/7 Screwdriver set Kraftform Plus Series 100. With reduced blade diameters and smaller handle diameters**

- Kraftform screwdrivers with reduced blade diameter as well as partially with slim handle design
- Allows screwdriving even in confined situations
- Low-lying screw and spring elements can be reached and actuated
- Safe work at a voltage of 1,000 volts, individually tested

**160 iSS/7 Screwdriver set Kraftform Plus Series 100. With reduced blade diameters and smaller handle diameters**



Code	EAN		
05135961001	4013288 178640		1
		160 iSS 1x 0,8x4,0x100	
		160 iS 1x 0,6x3,5x100; 1x 1,0x5,5x125	
		162 iSS 1x PH 1x80; 1x PH 2x100	
		165 iSS PZ/S 1x # 1x80; 1x # 2x100	

**160 i/168 i/6 Rack Screwdriver set Kraftform Plus Series 100, and rack**

- Including useful rack for well-arranged storage of the screwdrivers

**160 i/168 i/6 Rack Screwdriver set Kraftform Plus Series 100, and rack**



Code	EAN		
05347777001	4013288 122957		1
		162 i PH VDE 1x PH 1x80; 1x PH 2x100	
		160 i VDE 1x 0,6x3,5x100 <sup>1)</sup> ; 1x 1,0x5,5x125	
		168 i VDE 1x # 1x80; 1x # 2x100	

<sup>1)</sup>without Lasertip



### 160 i/162 i/167 i/9 Screwdriver set Kraftform Plus Series 100



Code		EAN		
		4013288		
05133355001	160065			1
		+	162 i PH VDE	1x PH 2x100
		+	165 i PZ VDE	1x PZ 2x100
		+	165 i PZ/S VDE	1x # 1x80; 1x # 2x100
		*	167 i TORX® VDE	1x TX 15x80; 1x TX 20x80; 1x TX 25x100
		●	160 i VDE	1x 0,4x2,5x80 <sup>1)</sup> ; 1x 1,0x5,5x125

<sup>1)</sup>without Lasertip

### 165 iS PZ/S # 1 + 2 Screwdriver set Kraftform Plus series 100. With reduced blade diameter

- Reduced shaft diameter: combination profile - Pozidriv / slotted
- Allows screwdriving even in confined situations
- Low-lying screw and spring elements can be reached and actuated

### 165 iS PZ/S # 1 + 2 Screwdriver set Kraftform Plus series 100. With reduced blade diameter



Code		EAN		
		4013288		
05006470001	214317			1
		+	165 iS PZ/S	1x # 1x80; 1x # 2x100

### Kraftform Kompakt VDE Stainless 17 extra slim 1 Tool finder

2x 3817 Kraftform VDE bitholding screwdrivers for ergonomic screwdriving. 15 VDE stainless blades, some of which with reduced blade diameter (iS), so that even low-lying screw and spring elements can be easily reached and operated; with "Take it easy" Tool finder: Colour coding by profile and laser-engraved size indication - for quick and easy identification of the required tool. Individually tested at 10,000 V for safe working at the approved voltage of 1,000 V.

Wera's stainless steel tools are vacuum ice tempered and therefore have the hardness and strength properties required for screw connections. Industrial use is possible without restrictions. In a robust belt pouch.

The pouch is suitable for attachment to walls, shelves, workshop trolleys and the Wera 2go system thanks to the hook and loop fastener system on the back.



### Kraftform Kompakt VDE Stainless 17 extra slim 1 Tool finder



Code		EAN		
		4013288		
05006631001	230034			1
		●	3817 VDE Stainless	2x 9x98
		+	Kraftform Kompakt VDE 3062 iS Take it easy	1x PH 1x157; 1x PH 2x157
		+	Kraftform Kompakt VDE 3065 iS Take it easy	1x PZ 1x157; 1x PZ 2x157
		+	Kraftform Kompakt VDE 3065 iS PZ/S Take it easy	1x # 1x157; 1x # 2x157
		*	Kraftform Kompakt VDE 3067 i Take it easy	1x TX 10x157
		*	Kraftform Kompakt VDE 3067 iS Take it easy	1x TX 15x157; 1x TX 20x157; 1x TX 25x157
		●	Kraftform Kompakt VDE 3060 i Take it easy	1x 0,4x2,5x157; 1x 1,2x6,5x157
		●	Kraftform Kompakt VDE 3060 iS Take it easy	1x 0,6x3,5x157; 1x 0,8x4,0x157; 1x 1,0x5,5x157
			Hook and Loop Fastener Strip 70	1x 50,0x70,0

### Kraftform Kompakt VDE Stainless 8 extra slim 1 Tool finder

One 3817 VDE Kraftform bitholding screwdriver for ergonomic screwdriving. 7 VDE stainless blades, some of which with reduced blade diameter (iS), so that even low-lying screw and spring elements can be easily reached and operated; with "Take it easy" Tool finder: Colour coding by profile and laser-engraved size indication - for quick and easy identification of the required tool. Individually tested at 10,000 V for safe working at the approved voltage of 1,000 V.

Wera's stainless steel tools are vacuum ice tempered and therefore have the hardness and strength properties required for screw connections. Industrial use is possible without restrictions.

In a robust belt pouch. The pouch is suitable for attachment to walls, shelves, workshop trolleys and the Wera 2go system thanks to the hook and loop fastener system on the back.

### Kraftform Kompakt VDE Stainless 8 extra slim 1 Tool finder



Code		EAN							
05006630001		4013288							1
			●	3817 VDE Stainless					
			⊛	Kraftform Kompakt VDE 3067 i Take it easy					
				1x TX 8x157; 1x TX 9x157; 1x TX 10x157; 1x TX 30x157					
			⊛	Kraftform Kompakt VDE 3067 iS Take it easy					
				1x TX 15x157; 1x TX 20x157; 1x TX 25x157					
				Hook and Loop Fastener Strip 70					
				1x 50,0x70,0					

### 3817 VDE Kraftform Stainless blade-holding handle SB

Premium VDE bitholding screwdriver solely for Wera VDE stainless blades. The handle/blade system allows for lightning-fast change of the required blade and thus a wide range of applications.

Kraftform Plus handle for comfortable ergonomic screwdriving, which avoids blisters and calluses. Hard handle zones for high working speeds, while soft handle zones guarantee a high torque transfer.

- Kraftform Kompakt VDE Stainless bitholding handle
- Smooth hard zones for high speed turning, soft grip zones for high torque transfer

### 3817 VDE Kraftform Stainless blade-holding handle SB



	EAN	⬡	⬡						
Code	4013288	mm	mm						
05003991001	220189	9	98						1

### Kraftform Kompakt VDE 3060 i Take it easy SB, stainless steel

VDE stainless blade for the Kraftform Kompakt handle/blade system for lightning-fast blade changes without special tools. Individually tested tools as per IEC 60900. Individually tested at 10,000 V for safe working at the approved voltage of 1,000 V.

Wera's stainless steel tools are vacuum ice hardened and therefore have the hardness and strength properties required for screw connections. Industrial use is possible without restrictions.

- Kraftform Kompakt VDE interchangeable blades for slotted screws
- Insulated, individually tested as per IEC 60900
- Blades made of stainless steel to prevent extraneous rust
- Vacuum ice-hardening provides the required hardness and strength
- 9 mm hex drive with with entry chamfer
- Take it easy tool finder: Colour coding by profile and laser-engraved size indication

### Kraftform Kompakt VDE 3060 i Take it easy SB, stainless steel



Code	EAN			
	4013288			
05006575001	229236	●	Kraftform Kompakt VDE 3060 i Take it easy 1x 0.4x2.5x157	5
05006576001	229243	●	Kraftform Kompakt VDE 3060 i Take it easy 1x 1.2x6.5x157	5

### Kraftform Kompakt VDE 3060 iS Take it easy SB, stainless steel

- Reduced shaft diameter and integrated insulation protection
- This means that low-lying screws and spring elements can be accessed and actuated
- Take it easy tool finder: Colour coding by profile and laser-engraved size indication



### Kraftform Kompakt VDE 3060 iS Take it easy SB, stainless steel



Code	EAN			
	4013288			
05006577001	229250	●	Kraftform Kompakt VDE 3060 iS Take it easy 1x 0.6x3.5x157	5
05006578001	229274	●	Kraftform Kompakt VDE 3060 iS Take it easy 1x 0.8x4.0x157	5
05006579001	229281	●	Kraftform Kompakt VDE 3060 iS Take it easy 1x 1.0x5.5x157	5

### Kraftform Kompakt VDE 3062 iS Take it easy SB, stainless steel

- Reduced shaft diameter and integrated insulation protection
- In this way, low-lying PH screws can be accessed and actuated
- Take it easy tool finder: Colour coding by profile and laser-engraved size indication

### Kraftform Kompakt VDE 3062 iS Take it easy SB, stainless steel



Code	EAN			
	4013288			
05006580001	229304	+	Kraftform Kompakt VDE 3062 iS Take it easy 1x PH 1x157	5
05006581001	229427	+	Kraftform Kompakt VDE 3062 iS Take it easy 1x PH 2x157	5

### Kraftform Kompakt VDE 3065 iS PZ Take it easy SB, stainless steel

- Reduced shaft diameter and integrated insulation protection
- In this way, low-lying PZ screws can be accessed and actuated
- Take it easy tool finder: Colour coding by profile and laser-engraved size indication

### Kraftform Kompakt VDE 3065 iS PZ Take it easy SB, stainless steel



Code	EAN		
05006582001	229533	+	Kraftform Kompakt VDE 3065 iS PZ Take it easy 1x PZ 1x157
05006583001	229540	+	Kraftform Kompakt VDE 3065 iS PZ Take it easy 1x PZ 2x157

### Kraftform Kompakt VDE 3065 iS PZ/S Take it easy SB, stainless steel

- Reduced shaft diameter and integrated insulation protection
  - In this way, low-lying PlusMinus screws can be accessed and actuated
- Take it easy tool finder: Colour coding by profile and laser-engraved size indication

### Kraftform Kompakt VDE 3065 iS PZ/S Take it easy SB, stainless steel



Code	EAN		
05006584001	229502	+	Kraftform Kompakt VDE 3065 iS PZ/S Take it easy 1x # 1x157
05006585001	229526	+	Kraftform Kompakt VDE 3065 iS PZ/S Take it easy 1x # 2x157

### Kraftform Kompakt VDE 3067 iS TORX® Take it easy SB, stainless steel

- Reduced shaft diameter and integrated insulation protection
- In this way, low-lying TORX® screws can be accessed and actuated
- Take it easy tool finder: Colour coding by profile and laser-engraved size indication

### Kraftform Kompakt VDE 3067 iS TORX® Take it easy SB, stainless steel



Code	EAN		
05006590001	229472	+	Kraftform Kompakt VDE 3067 iS Take it easy 1x TX 15x157
05006591001	229489	+	Kraftform Kompakt VDE 3067 iS Take it easy 1x TX 20x157
05006592001	229496	+	Kraftform Kompakt VDE 3067 iS Take it easy 1x TX 25x157

### Kraftform Kompakt VDE 3067 i TORX® Take it easy SB, stainless steel

- Kraftform Kompakt VDE interchangeable blade for TORX® screws
- Take it easy tool finder: Colour coding by profile and laser-engraved size indication

#### Kraftform Kompakt VDE 3067 i TORX® Take it easy SB, stainless steel



Code	EAN			
	4013288			
05006586001	229434		Kraftform Kompakt VDE 3067 i Take it easy 1x TX 8x157	5
05006587001	229441		Kraftform Kompakt VDE 3067 i Take it easy 1x TX 9x157	5
05006588001	229458		Kraftform Kompakt VDE 3067 i Take it easy 1x TX 10x157	5
05006589001	229465		Kraftform Kompakt VDE 3067 i Take it easy 1x TX 30x157	5

### 837 i RA Kraftform Blade-holding screwdriver with ratchet functionality

Bit-holding screwdriver for Wera Kraftform Kompakt VDE blades with ratchet with fine toothing integrated in the handle (40 teeth/return angle 9°). The ratchet accelerates screwdriving without having to reposition the tool.



The ratchet mechanism completely embedded in the handle ensures very handy and comfortable work. The handle/blade system allows for lightning-fast change of the required blade and thus a wide range of applications.

- Kraftform Kompakt VDE Kraftform blade-holding screwdriver with ratchet functionality
- The integrated ratchet with fine toothing ensures fast and safe working
- High working speed: The ratchet allows to “spin” when screwdriving
- Ergonomic intuitive switching to clockwise/counterclockwise or position 0
- Kraftform Plus handle for comfortable ergonomic work

#### 837 i RA Kraftform Blade-holding screwdriver with ratchet functionality

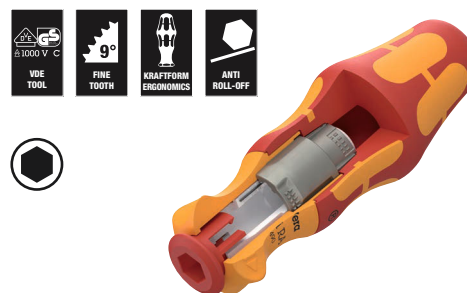

Code	EAN								
	4013288	mm	mm						
05057490001	229700	9	115						1

## Kraftform Kompakt VDE 17 RA 1

17-piece Kraftform Kompakt VDE set. One 837 i RA blade-holding screwdriver with ratchet functionality (40 teeth, 9° return angle), one 817 VDE bitholding screwdriver, 15 VDE blades with “Take it easy” Tool finder: Colour coding by profile and laser-engraved size indication. Individually tested tools as per IEC 60900.

Individually tested in a water quench at 10,000 V for safe working at the approved voltage of 1,000 V. In a robust belt pouch.

- One Kraftform Kompakt VDE Kraftform 837 i RA blade-holding screwdriver with ratchet functionality (40 teeth, 9° return angle) for blades, one 817 VDE bitholding screwdriver for blades
- The 837 i RA bitholding screwdriver with ratchet integrated in the handle ensures fast and safe working
- High working speed: The ratchet allows to “spin” when screwdriving
- Ergonomic intuitive switching to clockwise/counterclockwise or position 0
- VDE blades (157 mm length) with practical spinning function, anti-roll protection and “Take it easy” Tool finder: Colour coding by profile and laser-engraved size indication
- Individually tested tools as per IEC 60900
- In robust pouch
- Suitable for Wera 2go

## Kraftform Kompakt VDE 17 RA 1



Code	EAN		
05006618001	4013288 229694		1
		● 837 i RA 1x 9x115	
		● 817 VDE 1x 9x98	
		⊕ Kraftform Kompakt VDE 62 i Take it easy 1x PH 1x157; 1x PH 2x157	
		⊕ Kraftform Kompakt VDE 65 i Take it easy 1x PZ 1x157; 1x PZ 2x157	
		⊕ Kraftform Kompakt VDE 65 i PZ/S Take it easy 1x # 1x157; 1x # 2x157	
		⊕ Kraftform Kompakt VDE 67 i Take it easy 1x TX 10x157; 1x TX 15x157; 1x TX 20x157; 1x TX 25x157	
		◐ Kraftform Kompakt VDE 60 i Take it easy 1x 0,4x2,5x157; 1x 0,8x4,0x157; 1x 1,0x5,5x157; 1x 1,2x6,5x157	
		◐ Kraftform Kompakt VDE 60 iS Take it easy 1x 0,6x3,5x157	

## Kraftform Kompakt VDE 17 RA Imperial 1



Code	EAN		
05006619001	4013288 229885		1
		● 837 i RA 1x 9x115	
		● 817 VDE 1x 9x98	
		⊕ Kraftform Kompakt VDE 62 i Take it easy 1x PH 1x157; 1x PH 2x157	
		⊕ Kraftform Kompakt VDE 65 i PZ/S Take it easy 1x # 1x157; 1x # 2x157	
		⊕ Kraftform Kompakt VDE 67 i Take it easy 1x TX 10x157; 1x TX 15x157; 1x TX 20x157; 1x TX 25x157	
		◐ Kraftform Kompakt VDE 60 i Take it easy 1x 0,4x2,5x157; 1x 0,8x4,0x157; 1x 1,0x5,5x157; 1x 1,2x6,5x157	
		◐ Kraftform Kompakt VDE 60 iS Take it easy 1x 0,6x3,5x157	
		◐ Kraftform Kompakt VDE 68 i Take it easy 1x # 1x157; 1x # 2x157	

## Kraftform Kompakt & VDE - every size always available

### Kraftform Kompakt VDE 16 Torque 1.2-3.0 Nm extra slim 1 Tool finder

16-piece torque VDE blade set. Includes 14 blades (12 of which with reduced blade diameter) with integrated protective insulation.

With "Take it easy" Tool finder: Colour coding by profile and laser-engraved size indication - for quick and easy identification of the required tool. Torque VDE bitholding screwdriver with adjustable torque value from 1.2-3.0 Nm and 817 VDE bitholding screwdriver.

Both with ergonomic Kraftform Plus handle, with hard handle zones ensuring high working speeds while soft handle zones guarantee a high torque transfer.

### Kraftform Kompakt VDE 16 Torque 1.2-3.0 Nm extra slim 1 Tool finder

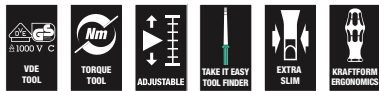

Code	EAN		
05006609001	4013288 229953		1
		7400 VDE 1x 7441 VDE, 1,2-3,0 Nm	
		817 VDE 1x 9x98	
		Kraftform Kompakt VDE 62 iS Take it easy 1x PH 1x157; 1x PH 2x157	
		Kraftform Kompakt VDE 65 iS Take it easy 1x PZ 1x157; 1x PZ 2x157	
		Kraftform Kompakt VDE 65 iS PZ/S Take it easy 1x # 1x157; 1x # 2x157	
		Kraftform Kompakt VDE 67 i Take it easy 1x TX 10x157	
		Kraftform Kompakt VDE 67 iS Take it easy 1x TX 15x157; 1x TX 20x157; 1x TX 25x157	
		Kraftform Kompakt VDE 60 i Take it easy 1x 0,4x2,5x157	
		Kraftform Kompakt VDE 60 iS Take it easy 1x 0,6x3,5x157; 1x 0,8x4,0x157; 1x 1,0x5,5x157	
		Hook and Loop Fastener Strip 70 1x 50,0x70,0	

## Kraftform Kompakt VDE 15 Torque 1.2-3.0 Nm extra slim 1 Tool finder

15-piece torque VDE blade set. One torque VDE bitholding screwdriver with adjustable torque value from 1.2-3.0 Nm.

With ergonomic Kraftform Plus handle, with hard handle zones ensuring high working speeds while soft handle zones guarantee a high torque transfer. Includes 14 blades (12 of which with reduced blade diameter) with integrated protective insulation.

With "Take it easy" Tool finder: Colour coding by profile and laser-engraved size indication - for quick and easy identification of the required tool.

In a robust belt pouch. The textile box features a fleece zone at the back. Using the provided self-adhesive hook and loop fastener strips, the textile box can be attached to the Wera 2go components. Or to the wall, shelf or workshop trolley.

### Kraftform Kompakt VDE 15 Torque 1.2-3.0 Nm extra slim 1 Tool finder



Code	EAN		
05006605001	4013288 229915		1
		7400 VDE 1x 7441 VDE, 1,2-3,0 Nm	
		Kraftform Kompakt VDE 62 iS Take it easy 1x PH 1x157; 1x PH 2x157	
		Kraftform Kompakt VDE 65 iS Take it easy 1x PZ 1x157; 1x PZ 2x157	
		Kraftform Kompakt VDE 65 iS PZ/S Take it easy 1x # 1x157; 1x # 2x157	
		Kraftform Kompakt VDE 67 i Take it easy 1x TX 10x157	
		Kraftform Kompakt VDE 67 iS Take it easy 1x TX 15x157; 1x TX 20x157; 1x TX 25x157	
		Kraftform Kompakt VDE 60 i Take it easy 1x 0,4x2,5x157	
		Kraftform Kompakt VDE 60 iS Take it easy 1x 0,6x3,5x157; 1x 0,8x4,0x157; 1x 1,0x5,5x157	
		Hook and Loop Fastener Strip 70 1x 50,0x70,0	

## Kraftform Kompakt VDE Big Pack 1

26-piece Kraftform Kompakt VDE set, 2x 817 VDE Kraftform blade-holding screwdrivers, 24 VDE blades (each 157 mm length) most of them with reduced blade diameter (iS), so that even low-lying screw and spring elements can be easily reached and operated. Individually tested as per IEC 60900 at 10,000 V for safe working at the approved voltage of 1,000 V.

“Take it easy” Tool finder with colour coding by profile and laser-engraved size indication - for quick and easy identification of the required tool. Kraftform Plus handle for comfortable ergonomic screwdriving, avoiding blisters and calluses. Hard handle zones for high working speeds, while soft handle zones guarantee a high torque transfer. The anti-roll protection avoids bits from rolling away annoyingly at the workplace.

- 2 VDE-insulated Kraftform 817 VDE blade-holding screwdrivers with anti-roll protection
- VDE blades (157 mm length) with practical spinning function, anti-roll protection and “Take it easy” Tool finder: Colour coding by profile and laser-engraved size indication
- Insulated tools, blades partly with reduced diameter for safe working at up to 1,000 Volt
- Individually tested tools as per IEC 60900
- In robust pouch
- Suitable for Wera 2go

## Kraftform Kompakt VDE Big Pack 1



Code	EAN		
05006617001	4013288 229557		1
		● 817 VDE 2x 9x98	
		⊕ Kraftform Kompakt VDE 62 iS Take it easy 1x PH 1x157; 1x PH 2x157	
		⊕ Kraftform Kompakt VDE 65 iS Take it easy 1x PZ 1x157; 1x PZ 2x157	
		⊕ Kraftform Kompakt VDE 62 iS PH/S Take it easy 1x # 1x157; 1x # 2x157	
		⊕ Kraftform Kompakt VDE 65 iS PZ/S Take it easy 1x # 1x157; 1x # 2x157	
		⊕ Kraftform Kompakt VDE 67 i Take it easy 1x TX 8x157; 1x TX 9x157; 1x TX 10x157; 1x TX 30x157	
		⊕ Kraftform Kompakt VDE 67 iS Take it easy 1x TX 15x157; 1x TX 20x157; 1x TX 25x157	
		○ Kraftform Kompakt VDE 64 i Take it easy 1x 2,5x157; 1x 3,0x157; 1x 4,0x157; 1x 5,0x157	
		● Kraftform Kompakt VDE 60 i Take it easy 1x 0,4x2,5x157; 1x 1,2x6,5x157	
		● Kraftform Kompakt VDE 60 iS Take it easy 1x 0,6x3,5x157; 1x 0,8x4,0x157; 1x 1,0x5,5x157	



### Kraftform Kompakt VDE 18 Universal 1 Tool finder

One 817 VDE Kraftform bitholding screwdriver, 12 VDE blades with "Take it easy" Tool finder: Colour coding by profile and laser-engraved size indication - for quick and easy identification of the required tool, 4 control cabinet keys, one single-pole phase tester. Individually tested at 10,000 V for safe working at the approved voltage of 1,000 V.

In a robust belt pouch. The textile box features a fleece zone at the back. Using the provided self-adhesive hook and loop fastener strips, the textile box can be attached to the Wera 2go components. Or to the wall, shelf or workshop trolley.

- VDE blades (157 mm length) with practical spinning function, anti-roll protection and "Take it easy" Tool finder: Colour coding by profile and laser-engraved size indication

### Kraftform Kompakt VDE 18 Universal 1 Tool finder



Code	EAN		
05006613001	229991		1
		● 817 VDE 1x 9x98	
		⊕ Kraftform Kompakt VDE 62 i Take it easy 1x PH 1x157; 1x PH 2x157	
		⊕ Kraftform Kompakt VDE 65 i Take it easy 1x PZ 1x157; 1x PZ 2x157	
		⊕ Kraftform Kompakt VDE 62 i PH/S Take it easy 1x # 1x157; 1x # 2x157	
		⊕ Kraftform Kompakt VDE 65 i PZ/S Take it easy 1x # 1x157; 1x # 2x157	
		⊖ Kraftform Kompakt VDE 60 i Take it easy 1x 0,4x2,5x157; 1x 0,6x3,5x157; 1x 0,8x4,0x157; 1x 1,0x5,5x157	
		● Kraftform Kompakt 96 VK 6,3 1x 6,3x89	
		● Kraftform Kompakt 97 VK 8,1 1x 8,1x89	
		▲ Kraftform Kompakt 98 DK 1x 89	
		● Kraftform Kompakt 99 FL 1x 89	
		● 247 1x 0,5x3,0x70	
		Hook and Loop Fastener Strip 70 1x 50,0x70,0	

Product not available in the USA and Canada.

### Kraftform Kompakt VDE 18 Imperial 1 Tool finder



Code	EAN		
05006616001	230027		1
		● 817 VDE 2x 9x98	
		⊕ Kraftform Kompakt VDE 62 i Take it easy 1x PH 1x157; 1x PH 2x157	
		⊕ Kraftform Kompakt VDE 62 i PH/S Take it easy 1x # 1x157; 1x # 2x157	
		⊕ Kraftform Kompakt VDE 65 i PZ/S Take it easy 1x # 1x157; 1x # 2x157	
		⊖ Kraftform Kompakt VDE 60 i Take it easy 1x 0,4x2,5x157; 1x 0,6x3,5x157; 1x 0,8x4,0x157; 1x 1,0x5,5x157	
		○ Kraftform Kompakt VDE 68 i Take it easy 1x # 1x157; 1x # 2x157	
		● Kraftform Kompakt 96 VK 6,3 1x 6,3x89	
		● Kraftform Kompakt 97 VK 8,1 1x 8,1x89	
		▲ Kraftform Kompakt 98 DK 1x 89	
		● Kraftform Kompakt 99 FL 1x 89	
		Hook and Loop Fastener Strip 70 1x 50,0x70,0	

## Kraftform Kompakt VDE 18 Universal 2 Tool finder



Code	EAN		
05006614001	4013288 230010		1
		● 817 VDE 2x 9x98	
		⊕ Kraftform Kompakt VDE 62 i Take it easy 1x PH 1x157; 1x PH 2x157	
		⊕ Kraftform Kompakt VDE 65 i Take it easy 1x PZ 1x157; 1x PZ 2x157	
		⊕ Kraftform Kompakt VDE 62 i PH/S Take it easy 1x # 1x157; 1x # 2x157	
		⊕ Kraftform Kompakt VDE 65 i PZ/S Take it easy 1x # 1x157; 1x # 2x157	
		⊖ Kraftform Kompakt VDE 60 i Take it easy 1x 0,4x2,5x157; 1x 0,6x3,5x157; 1x 0,8x4,0x157; 1x 1,0x5,5x157	
		■ Kraftform Kompakt 96 VK 6,3 1x 6,3x89	
		■ Kraftform Kompakt 97 VK 8,1 1x 8,1x89	
		▲ Kraftform Kompakt 98 DK 1x 89	
		● Kraftform Kompakt 99 FL 1x 89	
		Hook and Loop Fastener Strip 70 1x 50,0x70,0	

## Kraftform Kompakt VDE 17 extra slim 1 Tool finder

- Individually tested VDE interchangeable blades with reduced blade diameters
- 2 multi-component, ergonomic Kraftform VDE hand-holders with anti-roll protection
- In a robust textile box
- Multifunctional pliers for electrical installation: cable cutting, stripping, gripping, bending, deburring, crimping of wire end ferrules
- Pliers including cable shears with precision cutting edges (inductively hardened) for Cu and Al cables up to 5 x 2.5mm<sup>2</sup> / Ø 15 mm
- VDE blades (157 mm length) with practical spinning function, anti-roll protection and "Take it easy" Tool finder: Colour coding by profile and laser-engraved size indication

## Kraftform Kompakt VDE 17 extra slim 1 Tool finder



Code	EAN		
05006612001	4013288 229977		1
		● 817 VDE 2x 9x98	
		⊕ Kraftform Kompakt VDE 62 iS Take it easy 1x PH 1x157; 1x PH 2x157	
		⊕ Kraftform Kompakt VDE 65 iS Take it easy 1x PZ 1x157; 1x PZ 2x157	
		⊕ Kraftform Kompakt VDE 65 iS PZ/S Take it easy 1x # 1x157; 1x # 2x157	
		⊕ Kraftform Kompakt VDE 67 i Take it easy 1x TX 10x157	
		⊕ Kraftform Kompakt VDE 67 iS Take it easy 1x TX 15x157; 1x TX 20x157; 1x TX 25x157	
		⊖ Kraftform Kompakt VDE 60 i Take it easy 1x 0,4x2,5x157	
		⊖ Kraftform Kompakt VDE 60 iS Take it easy 1x 0,6x3,5x157; 1x 0,8x4,0x157; 1x 1,0x5,5x157	
		KNIPEX 13 96 200	
		Hook and Loop Fastener Strip 70 1x 50,0x70,0	

## Kraftform Kompakt VDE 17 Universal 1 Tool finder

- 17-piece set
- 2 VDE-insulated Kraftform 817 VDE blade-holding screwdrivers with anti-roll protection
- VDE blades (157 mm length) with practical spinning function, anti-roll protection and "Take it easy" Tool finder: Colour coding by profile and laser-engraved size indication
- Individually tested tools as per IEC 60900
- In robust pouch
- Suitable for Wera 2go

### Kraftform Kompakt VDE 17 Universal 1 Tool finder



Code	EAN		
05006611001	4013288 229564		1
		● 817 VDE 2x 9x98	
		⊕ Kraftform Kompakt VDE 62 i Take it easy 1x PH 1x157; 1x PH 2x157	
		⊕ Kraftform Kompakt VDE 65 i Take it easy 1x PZ 1x157; 1x PZ 2x157	
		⊕ Kraftform Kompakt VDE 65 i PZ/S Take it easy 1x # 1x157; 1x # 2x157	
		⊕ Kraftform Kompakt VDE 67 i Take it easy 1x TX 10x157; 1x TX 15x157; 1x TX 20x157; 1x TX 25x157	
		● Kraftform Kompakt VDE 60 i Take it easy 1x 0,4x2,5x157; 1x 0,8x4,0x157; 1x 1,0x5,5x157; 1x 1,2x6,5x157	
		● Kraftform Kompakt VDE 60 iS Take it easy 1x 0,6x3,5x157	
		Hook and Loop Fastener Strip 70 1x 50,0x70,0	

## Kraftform Kompakt VDE 16 extra slim 1 Tool finder

- VDE interchangeable blade with reduced shaft diameter
- Allows screwdriving even in confined situations
- Low-lying screw and spring elements can be reached and actuated
- VDE blades (157 mm length) with practical spinning function, anti-roll protection and "Take it easy" Tool finder: Colour coding by profile and laser-engraved size indication

### Kraftform Kompakt VDE 16 extra slim 1 Tool finder



Code	EAN		
05006608001	4013288 229946		1
		● 817 VDE 1x 9x98	
		⊕ Kraftform Kompakt VDE 62 iS Take it easy 1x PH 1x157; 1x PH 2x157	
		⊕ Kraftform Kompakt VDE 65 iS Take it easy 1x PZ 1x157; 1x PZ 2x157	
		⊕ Kraftform Kompakt VDE 65 iS PZ/S Take it easy 1x # 1x157; 1x # 2x157	
		⊕ Kraftform Kompakt VDE 67 i Take it easy 1x TX 10x157	
		⊕ Kraftform Kompakt VDE 67 iS Take it easy 1x TX 15x157; 1x TX 20x157; 1x TX 25x157	
		● Kraftform Kompakt VDE 60 i Take it easy 1x 0,4x2,5x157	
		● Kraftform Kompakt VDE 60 iS Take it easy 1x 0,6x3,5x157; 1x 0,8x4,0x157; 1x 1,0x5,5x157	
		● 247 1x 0,5x3,0x70	
		Hook and Loop Fastener Strip 70 1x 50,0x70,0	

<sup>\*)</sup>Product not available in the USA and Canada.



### Kraftform Kompakt VDE 16 Universal 1 Tool finder

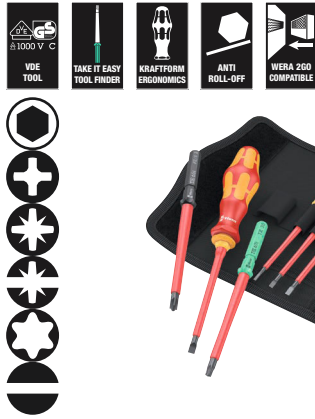

Code	EAN		
05006607001	4013288 229922		1
		● 817 VDE 1x 9x98	
		⊕ Kraftform Kompakt VDE 62 i Take it easy 1x PH 1x157; 1x PH 2x157	
		⊕ Kraftform Kompakt VDE 65 i Take it easy 1x PZ 1x157; 1x PZ 2x157	
		⊕ Kraftform Kompakt VDE 65 i PZ/S Take it easy 1x # 1x157; 1x # 2x157	
		⊕ Kraftform Kompakt VDE 67 i Take it easy 1x TX 10x157; 1x TX 15x157; 1x TX 20x157; 1x TX 25x157	
		● Kraftform Kompakt VDE 60 i Take it easy 1x 0,4x2,5x157; 1x 0,6x3,5x157; 1x 0,8x4,0x157; 1x 1,0x5,5x157	
		● 247 1x 0,5x3,0x70	
		Hook and Loop Fastener Strip 70 1x 50,0x70,0	

\*Product not available in the USA and Canada.

### Kraftform Kompakt VDE 7 extra slim 1 Tool finder

- Individually tested VDE interchangeable blades with reduced blade diameters
- In robust folding pouch with Wera 2go compatibility
- VDE blades (157 mm length) with practical spinning function, anti-roll protection and "Take it easy" Tool finder: Colour coding by profile and laser-engraved size indication

### Kraftform Kompakt VDE 7 extra slim 1 Tool finder

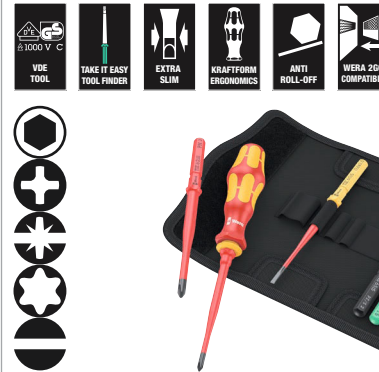

Code	EAN		
05006603001	4013288 229687		1
		● 817 VDE 1x 9x98	
		⊕ Kraftform Kompakt VDE 62 iS Take it easy 1x PH 1x157; 1x PH 2x157	
		⊕ Kraftform Kompakt VDE 65 iS PZ/S Take it easy 1x # 2x157	
		⊕ Kraftform Kompakt VDE 67 iS Take it easy 1x TX 15x157; 1x TX 20x157	
		● Kraftform Kompakt VDE 60 iS Take it easy 1x 0,6x3,5x157	
		Hook and Loop Fastener Strip 70 1x 50,0x70,0	

### Kraftform Kompakt VDE 7 Universal 1 Tool finder

One 817 VDE Kraftform bitholding screwdriver and 6 VDE blades with "Take it easy" Tool finder: Colour coding and laser-engraved size indication. Individually tested at 10,000 V for safe working at the approved voltage of 1,000 V.

In a robust belt pouch. The textile box features a fleece zone at the back. Using the provided self-adhesive hook and loop fastener strips, the textile box can be attached to the Wera 2go components. Or to the wall, shelf or workshop trolley.

- VDE blades (157 mm length) with practical spinning function, anti-roll protection and "Take it easy" Tool finder: Colour coding by profile and laser-engraved size indication

### Kraftform Kompakt VDE 7 Universal 1 Tool finder



<b>Code</b>	<b>EAN</b>		
0500660001	4013288 229663		1
		● 817 VDE 1x 9x98	
		⊕ Kraftform Kompakt VDE 62 i Take it easy 1x PH 1x157; 1x PH 2x157	
		⊖ Kraftform Kompakt VDE 60 i Take it easy 1x 0,4x2,5x157; 1x 0,6x3,5x157; 1x 0,8x4,0x157; 1x 1,0x5,5x157	
		Hook and Loop Fastener Strip 70 1x 50,0x70,0	

### Kraftform Kompakt VDE 7 Imperial 1 Tool finder



<b>Code</b>	<b>EAN</b>		
05006604001	4013288 229892		1
		● 817 VDE 1x 9x98	
		⊕ Kraftform Kompakt VDE 62 i Take it easy 1x PH 1x157; 1x PH 2x157	
		⊖ Kraftform Kompakt VDE 60 i Take it easy 1x 0,6x3,5x157; 1x 1,0x5,5x157	
		□ Kraftform Kompakt VDE 68 i Take it easy 1x # 1x157; 1x # 2x157	
		Hook and Loop Fastener Strip 70 1x 50,0x70,0	

### Kraftform Kompakt VDE 7 Universal 2 Tool finder



<b>Code</b>	<b>EAN</b>		
05006601001	4013288 229670		1
		● 817 VDE 1x 9x98	
		⊕ Kraftform Kompakt VDE 65 i Take it easy 1x PZ 1x157; 1x PZ 2x157	
		⊖ Kraftform Kompakt VDE 60 i Take it easy 1x 0,4x2,5x157; 1x 0,6x3,5x157; 1x 0,8x4,0x157; 1x 1,0x5,5x157	
		Hook and Loop Fastener Strip 70 1x 50,0x70,0	

### Series 7400 VDE Kraftform adjustable torque handle (0.3-3.5 Nm)

- Adjustable Kraftform VDE torque holder
- Adjustable torque from 0.3-1.2
- Distinct audible and perceivable excess load signal when the pre-set torque value is reached
- Suitable for Kraftform Kompakt VDE blades
- Rapid exchange of the interchangeable blades

### Series 7400 VDE Kraftform adjustable torque handle (0.3-3.5 Nm)



<b>Code</b>	<b>EAN</b>	<b>Art.No.</b>					
			mm	Nm	Nm	mm	
05074752001	179111	7440 VDE	9	0,3-1,2	0,05	192	7 9/16" 1
05074750001	168535	7441 VDE	9	1,2-3,0	0,10	192	7 9/16" 1
05074757001	184412	7444 VDE	9	1,7-3,5	0,10	192	7 9/16" 1

## Kraftform Kompakt Turbo i 1 Tool finder

Many users wish to carry out screwdriving operations faster without compromises. With a screwdriver which is precise, allows powerful end screwdriving and is also much faster than a conventional screwdriver. The solution: A planetary drive that can be switched on and off: Integrated in the handle it quadruples the working speed in smooth couplings all mechanically. One hand holds the front part of the handle, the second hand turns the back part of the handle.

The turbo function can be switched on and off at the push of a button. Turning it off is recommended for tightening and loosening with high torque as well as for fine adjustments. Robust, maintenance-free steel drive with maximum torque of 14 Nm when the turbo function is deactivated.

In the VDE version, the 827 T i Kraftform Turbo bitholding screwdriver with the Wera VDE blades individually tested as per IEC 60900 ensures fast and safe working even under tension (up to 1,000 volt). VDE blades with "Take it easy" Tool finder: Colour coding by profile and laser-engraved size indication - for quick and easy identification of the required tool. In a robust belt pouch. The textile box features a fleece zone at the back. Using the provided self-adhesive hook and loop fastener strips, the textile box can be attached to the Wera 2go components. Or to the wall, shelf or workshop trolley.

- 4 times the screwdriving speed thanks to the turbo function (purely mechanical - without battery)
- Activate and deactivate the turbo function by a simple push of a button
- Turbo function especially for smooth couplings
- Can be used without the turbo function like a normal screwdriver for couplings with steadily increasing torque
- Robust, maintenance-free gear made of steel

## Kraftform Kompakt Turbo i 1 Tool finder



Code	EAN			
	4013288			
05006640001	230041			1
			<b>827 T Kraftform Turbo</b> 1x 9x125	
			<b>817 VDE</b> 1x 9x98	
			<b>Kraftform Kompakt VDE 62 iS Take it easy</b> 1x PH 1x157; 1x PH 2x157	
			<b>Kraftform Kompakt VDE 65 iS Take it easy</b> 1x PZ 1x157; 1x PZ 2x157	
			<b>Kraftform Kompakt VDE 65 iS PZ/S Take it easy</b> 1x # 1x157; 1x # 2x157	
			<b>Kraftform Kompakt VDE 67 i Take it easy</b> 1x TX 10x157	
			<b>Kraftform Kompakt VDE 67 iS Take it easy</b> 1x TX 15x157; 1x TX 20x157; 1x TX 25x157	
			<b>Kraftform Kompakt VDE 60 i Take it easy</b> 1x 0,4x2,5x157	
			<b>Kraftform Kompakt VDE 60 iS Take it easy</b> 1x 0,6x3,5x157; 1x 0,8x4,0x157; 1x 1,0x5,5x157	
			<b>Hook and Loop Fastener Strip 120</b> 1x 50,0x120,0	

## 817 VDE Kraftform blade-holding handle

- Kraftform Kompakt VDE Kraftform handle
- Exclusively for Wera VDE interchangeable blades
- Smooth hard zones for high speed turning, soft grip zones for high torque transfer
- Hexagonal anti-roll feature against rolling away

## 817 VDE Kraftform blade-holding handle



Code	EAN								
05003990001	104359	9	102						1

## Kraftform Kompakt Turbo i Imperial 1 Tool finder



Code	EAN			
05006641001	4013288 230058			1
		●	827 T Kraftform Turbo 1x 9x125	
		●	817 VDE 1x 9x98	
		+	Kraftform Kompakt VDE 62 iS Take it easy 1x PH 1x157; 1x PH 2x157	
		+	Kraftform Kompakt VDE 62 iS PH/S Take it easy 1x # 1x157; 1x # 2x157	
		⊗	Kraftform Kompakt VDE 67 i Take it easy 1x TX 10x157	
		⊗	Kraftform Kompakt VDE 67 iS Take it easy 1x TX 15x157; 1x TX 20x157; 1x TX 25x157	
		◐	Kraftform Kompakt VDE 60 i Take it easy 1x 0,4x2,5x157	
		◐	Kraftform Kompakt VDE 60 iS Take it easy 1x 0,6x3,5x157; 1x 0,8x4,0x157; 1x 1,0x5,5x157	
		◻	Kraftform Kompakt VDE 68 iS Take it easy 1x # 1x157; 1x # 2x157	
			Hook and Loop Fastener Strip 120 1x 50,0x120,0	

## 827 T i Kraftform Turbo hand holder

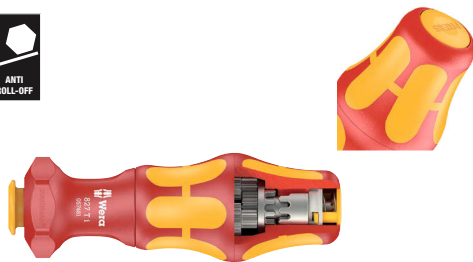

Code	EAN	mm	mm				
05057481001	4013288 214607	9	125				1

## Kraftform Kompakt VDE 60 i Take it easy

VDE blades for Kraftform Kompakt handle/interchangeable blade system for rapid exchange of the blades without any special tools. Individually tested as per IEC 60900. Individual testing at 10,000 volts so as to ensure safe working at the permitted voltage of 1,000 volts.

- Take it easy tool finder: Colour coding by profile and laser-engraved size indication



## Kraftform Kompakt VDE 60 i Take it easy



Code	EAN	mm	mm	mm	mm	mm	
05006500001	228420	0,4	2,5	157	3/32"	6 3/16"	5
05006501001	228437	0,5	3,0	157	1/8"	6 3/16"	5
05006502001	228444	0,6	3,5	157	9/64"	6 3/16"	5
05006503001	228451	0,8	4,0	157	5/32"	6 3/16"	5
05006504001	228468	1,0	5,5	157	7/32"	6 3/16"	5
05006505001	228475	1,2	6,5	157	1/4"	6 3/16"	5

## Kraftform Kompakt VDE 60 i Take it easy SB



Code	EAN			
05006550001	228925	◐	Kraftform Kompakt VDE 60 i Take it easy 1x 0.4x2.5x157	5
05006551001	228932	◐	Kraftform Kompakt VDE 60 i Take it easy 1x 0.5x3.0x157	5
05006552001	229007	◐	Kraftform Kompakt VDE 60 i Take it easy 1x 0.6x3.5x157	5
05006553001	229014	◐	Kraftform Kompakt VDE 60 i Take it easy 1x 0.8x4.0x157	5
05006554001	229021	◐	Kraftform Kompakt VDE 60 i Take it easy 1x 1.0x5.5x157	5
05006555001	229038	◐	Kraftform Kompakt VDE 60 i Take it easy 1x 1.2x6.5x157	5

### Kraftform Kompakt VDE 60 iS Take it easy

- Reduced shaft diameter and integrated insulation protection
- Allows screwdriving even in confined situations
- Low-lying screw and spring elements can be reached and actuated
- Take it easy tool finder: Colour coding by profile and laser-engraved size indication

#### Kraftform Kompakt VDE 60 iS Take it easy



Code	EAN	mm	mm	mm	mm	mm	mm	mm	mm
05006506001	228482	0,6	3,5	157	9/64"	6 3/16"			5
05006507001	228499	0,8	4,0	157	5/32"	6 3/16"			5
05006508001	228505	1,0	5,5	157	7/32"	6 3/16"			5

#### Kraftform Kompakt VDE 60 iS Take it easy SB



Code	EAN	mm	mm	mm	mm	mm	mm	mm	mm
05006556001	229045	0,6	3,5	157	9/64"	6 3/16"			5
05006557001	229052	0,8	4,0	157	5/32"	6 3/16"			5
05006558001	229069	1,0	5,5	157	7/32"	6 3/16"			5

#### Kraftform Kompakt VDE 62 i Take it easy



Code	EAN	mm	mm	mm	mm	mm	mm	mm	mm
05006509001	228512	PH 0	157	6 3/16"					5
05006510001	228529	PH 1	157	6 3/16"					5
05006511001	228536	PH 2	157	6 3/16"					5

### Kraftform Kompakt VDE 62 iS Take it easy

- Reduced shaft diameter and integrated insulation protection
- Allows screwdriving even in confined situations
- Low-lying screw and spring elements can be reached and actuated
- Take it easy tool finder: Colour coding by profile and laser-engraved size indication

#### Kraftform Kompakt VDE 62 iS Take it easy

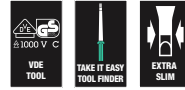

Code	EAN	mm	mm	mm	mm	mm	mm	mm	mm
05006512001	228543	PH 1	157	6 3/16"					5
05006513001	228550	PH 2	157	6 3/16"					5

#### Kraftform Kompakt VDE 62 iS Take it easy SB



Code	EAN	mm	mm	mm	mm	mm	mm	mm	mm
05006559001	229076	PH 1	157	6 3/16"					5
05006560001	229083	PH 2	157	6 3/16"					5

#### Kraftform Kompakt VDE 65 i Take it easy



Code	EAN	mm	mm	mm	mm	mm	mm	mm	mm
05006523001	228659	PZ 0	157	6 3/16"					5
05006524001	228666	PZ 1	157	6 3/16"					5
05006525001	228673	PZ 2	157	6 3/16"					5



### Kraftform Kompakt VDE 65 iS Take it easy

- Reduced shaft diameter and integrated insulation protection
- Allows screwdriving even in confined situations
- Low-lying screw and spring elements can be reached and actuated
- Take it easy tool finder: Colour coding by profile and laser-engraved size indication

#### Kraftform Kompakt VDE 65 iS Take it easy



	EAN						
Code	4013288			mm			
05006526001	228680	PZ 1		157	6 3/16"		5
05006527001	228697	PZ 2		157	6 3/16"		5

#### Kraftform Kompakt VDE 65 iS Take it easy SB



Code	EAN						
Code	4013288						
05006566001	229212				Kraftform Kompakt VDE 65 iS Take it easy 1x PZ 1x157		5
05006567001	229229				Kraftform Kompakt VDE 65 iS Take it easy 1x PZ 2x157		5

### Kraftform Kompakt VDE 62 i PH/S Take it easy

- Kraftform Kompakt VDE interchangeable blade for PlusMinus screws slotted/Phillips
- Particularly for jobs on terminal blocks, fuse boxes, switches and relays
- Take it easy tool finder: Colour coding by profile and laser-engraved size indication

#### Kraftform Kompakt VDE 62 i PH/S Take it easy



	EAN						
Code	4013288				mm		
05006514001	228567	# 1			157	6 3/16"	5
05006515001	228574	# 2			157	6 3/16"	5

### Kraftform Kompakt VDE 62 iS PH/S Take it easy

- Kraftform Kompakt VDE interchangeable blade for PlusMinus screws slotted/Phillips
- Reduced shaft diameter and integrated insulation protection
- Allows screwdriving even in confined situations
- Low-lying screw and spring elements can be reached and actuated
- Take it easy tool finder: Colour coding by profile and laser-engraved size indication

#### Kraftform Kompakt VDE 62 iS PH/S Take it easy



	EAN						
Code	4013288				mm		
05006516001	228581	# 1			157	6 3/16"	5
05006517001	228598	# 2			157	6 3/16"	5

### Kraftform Kompakt VDE 65 i PZ/S Take it easy

- Combination profile - Pozidriv/slotted
- Particularly for jobs on terminal blocks, fuse boxes, switches and relays
- Take it easy tool finder: Colour coding by profile and laser-engraved size indication

#### Kraftform Kompakt VDE 65 i PZ/S Take it easy



	EAN						
Code	4013288				mm		
05006528001	228703	# 1			157	6 3/16"	5
05006529001	228710	# 2			157	6 3/16"	5

### Kraftform Kompakt VDE 65 iS PZ/S Take it easy

- Combination profile - Pozidriv/slotted
- Reduced shaft diameter and integrated insulation protection
- Allows screwdriving even in confined situations
- Low-lying screw and spring elements can be reached and actuated
- Take it easy tool finder: Colour coding by profile and laser-engraved size indication

### Kraftform Kompakt VDE 65 iS PZ/S Take it easy



	EAN					
Code	4013288		mm			
05006530001	228727	# 1	157	6 3/16"		5
05006531001	228734	# 2	157	6 3/16"		5

### Kraftform Kompakt VDE 65 iS PZ/S Take it easy SB



	Code	EAN			
		4013288			
05006568001	229199		Kraftform Kompakt VDE 65 i PZ/S Take it easy 1x # 1x157		5
05006569001	229205		Kraftform Kompakt VDE 65 iS PZ/S Take it easy 1x # 2x157		5

### Kraftform Kompakt VDE 67 i TORX® Take it easy

- Kraftform Kompakt VDE interchangeable blade for hexagon socket screws
- Take it easy tool finder: Colour coding by profile and laser-engraved size indication

### Kraftform Kompakt VDE 67 i TORX® Take it easy



	EAN					
Code	4013288		mm			
05006532001	228758	TX 8	157	6 3/16"		5
05006533001	228765	TX 9	157	6 3/16"		5
05006534001	228772	TX 10	157	6 3/16"		5
05006535001	228789	TX 15	157	6 3/16"		5
05006536001	228796	TX 20	157	6 3/16"		5
05006537001	228802	TX 25	157	6 3/16"		5
05006538001	228819	TX 27	157	6 3/16"		5
05006539001	228826	TX 30	157	6 3/16"		5

### Kraftform Kompakt VDE 67 i TORX® Take it easy SB

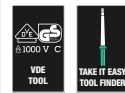

	Code	EAN			
		4013288			
05006570001	229151		Kraftform Kompakt VDE 67 i Take it easy 1x TX 10x157		5
05006571001	229144		Kraftform Kompakt VDE 67 i Take it easy 1x TX 15x157		5
05006572001	229168		Kraftform Kompakt VDE 67 i Take it easy 1x TX 20x157		5
05006573001	229175		Kraftform Kompakt VDE 67 i Take it easy 1x TX 25x157		5
05006574001	229182		Kraftform Kompakt VDE 67 i Take it easy 1x TX 30x157		5

### Kraftform Kompakt VDE 67 iS TORX® Take it easy

- Reduced shaft diameter and integrated insulation protection
- Allows screwdriving even in confined situations
- Low-lying screw and spring elements can be reached and actuated
- Take it easy tool finder: Colour coding by profile and laser-engraved size indication

### Kraftform Kompakt VDE 67 iS TORX® Take it easy



	EAN							
<b>Code</b>	4013288		mm					
05006540001	228833	TX 15	157	6 3/16"				5
05006541001	228840	TX 20	157	6 3/16"				5
05006542001	228857	TX 25	157	6 3/16"				5

### Kraftform Kompakt VDE 68 i Take it easy



	EAN							
<b>Code</b>	4013288		mm					
05006543001	228864	# 1	157	6 3/16"				5
05006544001	228871	# 2	157	6 3/16"				5

### Kraftform Kompakt VDE 68 iS Take it easy

- Reduced shaft diameter and integrated insulation protection
- Allows screwdriving even in confined situations
- Low-lying screw and spring elements can be reached and actuated
- Take it easy tool finder: Colour coding by profile and laser-engraved size indication

### Kraftform Kompakt VDE 68 iS Take it easy



	EAN							
<b>Code</b>	4013288		mm					
05006545001	228888	# 1	157	6 3/16"				5
05006546001	228895	# 2	157	6 3/16"				5

### Kraftform Kompakt VDE 64 i Take it easy

- Kraftform Kompakt VDE interchangeable blade for hexagon socket screws
- With Hex-Plus profile (prevents hexagonal socket screws from cylindrical turning)
- Take it easy tool finder: Colour coding by profile and laser-engraved size indication



### Kraftform Kompakt VDE 64 i Take it easy

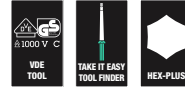

	EAN							
<b>Code</b>	4013288		mm	mm				
05006518001	228604	2,5	157	6 3/16"				5
05006519001	228611	3,0	157	6 3/16"				5
05006520001	228628	4,0	157	6 3/16"				5
05006521001	228635	5,0	157	6 3/16"				5
05006522001	228642	6,0	157	6 3/16"				5

### Kraftform Kompakt VDE 64 i Take it easy SB



	EAN			
<b>Code</b>	4013288			
05006561001	229090		Kraftform Kompakt VDE 64 i Take it easy 1x 2.5x157	5
05006562001	229106		Kraftform Kompakt VDE 64 i Take it easy 1x 3.0x157	5
05006563001	229113		Kraftform Kompakt VDE 64 i Take it easy 1x 4.0x157	5
05006564001	229120		Kraftform Kompakt VDE 64 i Take it easy 1x 5.0x157	5
05006565001	229137		Kraftform Kompakt VDE 64 i Take it easy 1x 6.0x157	5

### Kraftform Kompakt 96 VK 6,3

Glass-fibre reinforced switch cabinet key. Blade for Kraftform Kompakt handle/interchangeable blade system for rapid exchange of the blade without needing any special tools - square socket.

#### Kraftform Kompakt 96 VK 6,3



	EAN							
Code	4013288	mm	mm					
05003460001	105349	6,3	89	3 9/16"				5

### Kraftform Kompakt 97 VK 8,1

- Kraftform Kompakt switch cabinet key 8.1 mm

#### Kraftform Kompakt 97 VK 8,1



	EAN							
Code	4013288	mm	mm					
05003461001	105370	8,1	89	3 9/16"				5

### Kraftform Kompakt 98 DK



	EAN							
Code	4013288		mm					
05003462001	105356		89	3 9/16"				5

### Kraftform Kompakt 99 FL



	EAN							
Code	4013288		mm					
05003463001	105363		89	3 9/16"				5

### Kraftform – Series 1000 VDE

Premium Kraftform VDE screwdriver. Multi-component Kraftform handle for fast and gentle work. The Wera Black Point tip and a sophisticated hardening process guarantee a long usability for the tip, increased corrosion protection and exact fitting accuracy.

Individually tested at 10,000 V for safe working at the approved voltage of 1,000 V. The hexagon anti-roll protection avoids bits from rolling away annoyingly at the workplace. Handles marked to find and sort the tools easily.

- Insulated screwdriver for safe working up to 1,000 volts
- Individually tested
- Multi-component Kraftform handle for fast and low-fatigue working
- Handle markings simplify finding and sorting of tools
- The Wera Black Point tip offers an exact fit and optimum corrosion protection

#### 1060 i VDE-insulated Kraftform slotted screwdriver



	EAN							
Code	4013288	mm	mm	mm	mm			
05051580001	222268	0,4	2,5	80	81	3/32"	3 1/8"	10
05051582001	222275	0,6	3,5	100	81	9/64"	4"	10
05051583001	222282	0,8	4,0	100	98	5/32"	4"	10
05051587001	222299	1,0	5,5	125	98	7/32"	5"	10

### 1062 i PH VDE-insulated Kraftform Phillips-head screwdriver



	EAN						
Code	4013288		mm	mm			
05051601001	222220	PH 1	80	98	3 1/8"		5
05051603001	222237	PH 2	100	105	4"		5

### 1065 i PZ VDE-insulated Kraftform Phillips-head screwdriver



	EAN						
Code	4013288		mm	mm			
05051611001	222244	PZ 1	80	98	3 1/8"		5
05051613001	222251	PZ 2	100	105	4"		5

### 1060 i/1062 i/6 Kraftform VDE screwdriver set

Premium Kraftform VDE screwdriver set. Multi-component Kraftform handle for fast and gentle work. The Wera Black Point tip and a sophisticated hardening process guarantee a long usability for the tip, increased corrosion protection and exact fitting accuracy.

Individually tested at 10,000 V for safe working at the approved voltage of 1,000 V. The hexagon anti-roll protection avoids bits from rolling away annoyingly at the workplace. Handles marked to find and sort the tools easily.



### 1060 i/1062 i/6 Kraftform VDE screwdriver set



Code	EAN		
05051575001	222381		1
		<b>1062 i PH VDE</b> 1x PH 1x80; 1x PH 2x100	
		<b>1060 i VDE</b> 1x 0,4x2,5x80; 1x 0,6x3,5x100; 1x 0,8x4,0x100; 1x 1,0x5,5x125	

### 1060 i/1065 i/6 Kraftform VDE screwdriver set



Code	EAN		
05051576001	222374		1
		<b>1065 i PZ VDE</b> 1x PZ 1x80; 1x PZ 2x100	
		<b>1060 i VDE</b> 1x 0,4x2,5x80; 1x 0,6x3,5x100; 1x 0,8x4,0x100; 1x 1,0x5,5x125	

### 410 i VDE B VDE-insulated T-handle adapter screwdriver for 3/8" sockets

The shape of the T-handle allows a transmission of particularly high tightening and loosening torque. The geometry of the handle fills the hand well and the fingers lie safely in the soft rounded handle recesses.

This ensures optimal, ergonomic power transmission. Individually tested tool as per IEC 60900 at 10,000 V for safe working at the approved voltage of 1,000 V.

Only allowed for 3/8" VDE bit sockets and sockets of the Wera Zyklop VDE series 8740, 8760, 8767, 8790. The coated handle protects even sensitive surfaces from damage.

- 3/8" VDE T-handle screwdriver for the transmission of particularly high tightening and loosening torque
- Ergonomic 2-component T-handle with handle recesses and a pleasant feel for a very high power transmission and fatigue-free working.
- Insulated, individually tested tool as per IEC 60900 for safe working up to 1.000 V
- Only allowed for 3/8" VDE bit sockets and sockets of the Wera Zyklop VDE series 8740, 8760, 8767, 8790

### 410 i VDE B VDE-insulated T-handle adapter screwdriver for 3/8" sockets

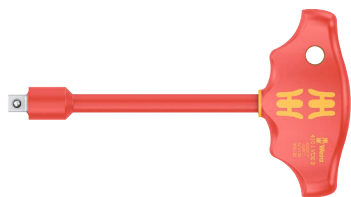

Code	EAN	Drive	Length	Width	Height	Weight	Box
05005120001	222664	3/8"	130	49	99	5 1/8"	1

### 8100 SB VDE 1 Zyklop Ratchet set, insulated, switch lever, 3/8" drive, metric

Incredibly compact set arrangement for a lot of tools in a small space. Individually tested ratchet, sockets and extensions as per IEC 60900 at 10,000V for safe working at the approved voltage of 1,000V.

Textile box with very high robustness and durability can be positioned upright for clear storage in the workshop shelf. Additional surface protection through textile outer material. Low weight and volume for easier mobility. Smooth turning mechanism for secure hold and easy removal of VDE sockets.

- Insulated and 100% individually tested Zyklop ratchets, sockets and extensions for safe working up to 1,000 volts
- Fine-toothed ratchet with 80 teeth for a short return angle of 4.5°
- Extremely slim design with a soft, ergonomic grip zone for easy work even in very confined spaces
- Robust and extremely compact textile box with socket holders, which ensure a secure hold and easy socket removal by means of a rotating mechanism
- Tools and textile box protect sensitive surfaces, the box is Wera 2go compatible

### 8100 SB VDE 1 Zyklop Ratchet set, insulated, switch lever, 3/8" drive, metric



Code	EAN	Content	Box
05004970001	190970	<ul style="list-style-type: none"> <li>8007 B VDE 1x 3/8"x222,0</li> <li>8790 B VDE 1x 6,0x46,0; 1x 7,0x46,0; 1x 8,0x46,0; 1x 9,0x46,0; 1x 10,0x46,0; 1x 11,0x46,0; 1x 12,0x46,0; 1x 13,0x46,0; 1x 14,0x46,0; 1x 15,0x46,0; 1x 16,0x46,0; 1x 17,0x46,0; 1x 18,0x46,0; 1x 19,0x46,0</li> <li>8794 SB VDE 1x 3/8"x91,0</li> <li>8794 LB VDE 1x 3/8"x166,0</li> </ul>	1

**Belt B VDE 1 Zyklop bit socket set TORX® hexagonal socket with holding function, 3/8" drive**

10 Zyklop bit sockets, with 3/8" drive, insulated, individually tested as per IEC 60900. Increased safety due to 2-component isolation with yellow core under red insulation outer layer visible in case of damage to outer red VDE insulation layer. With holding function for TORX® screws to Acument Intellectual Properties specifications or holding function for hexagonal socket screws. Robust textile belt in the typical Wera design with 10 VDE bit sockets in a compact space. A smooth turning mechanism ensures secure holding and easy removal of the sockets. Includes snap hook for attaching to belt loops or bags. With fleece backing and hook and loop fastener strips for easy attachment e.g. on wall, shelf, workshop trolley and Wera 2go tool transport system. VDE 3/8" bit socket and holding function for particularly comfortable screwdriving with reduced risk of screw loss when feeding to the component. With increased safety due to yellow insulation core, which becomes visible in case of damage to the outer red VDE insulation layer. Individually tested tool as per IEC 60900 at 10,000 V for safe working at the approved voltage of 1,000 V.

- 10-piece 3/8" socket set on robust textile belt
- Smooth Twist to Unlock mechanism for a secure fit and simple removal of the sockets
- Extremely short and compact 3/8" bit socket for easy work even in very confined spaces
- The holding function holds screws securely on the tool
- Individually tested tool as per IEC 60900 at 10,000 V for safe working at up to 1,000 volts
- Suitable for attachment to a wall, shelf, tool trolley and to the Wera 2go System

**Belt B VDE 1 Zyklop bit socket set TORX® hexagonal socket with holding function, 3/8" drive**



	<b>Code</b>	<b>EAN</b>		
	05004930001	4013288 210234		1
			<b>8767 B VDE HF</b> 1x TX 20x55,0; 1x TX 25x55,0; 1x TX 27x55,0; 1x TX 30x55,0; 1x TX 40x55,0; 1x TX 45x59,0	
			<b>8740 B VDE HF</b> 1x 4,0x55,0; 1x 5,0x55,0; 1x 6,0x55,0; 1x 8,0x59,0	
			<b>Belt B VDE 0/10</b> 1x 71,0x209,0	
			<b>K30</b> 1x 30,0x200,0	

**8007 B VDE Zyklop ratchet, insulated, with switch lever, with 3/8" drive**

- Insulated and 100% individually tested Zyklop ratchet for safe working up to 1,000 volts
- Fine toothing with 80 teeth for a short return angle of only 4.5°
- Extremely slim design with a soft, ergonomic grip zone for easy work even in very confined spaces
- Safe socket lock via push button, convenient direction change thanks to the reversing lever
- Plastic coating protects surfaces from damage

**8007 B VDE Zyklop ratchet, insulated, with switch lever, with 3/8" drive**

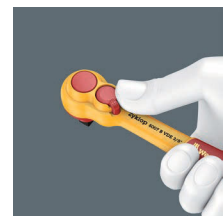

	<b>Code</b>	<b>EAN</b>							
	05004966001	4013288 190963	3/8"	mm	222,0				3

### 8790 B VDE Zyklop $\frac{3}{8}$ " socket, insulated

- Individually tested tool as per IEC 60900 at 10,000V
- Increased safety due to 2-component isolation with yellow insulation core under red insulation outer layer
- Plastic coating protects surfaces from damage

### 8790 B VDE Zyklop $\frac{3}{8}$ " socket, insulated



	EAN						
Code	4013288	mm	mm	mm	mm		
05004950001	192936	6,0	46,0	14,8	23,0		1
05004951001	192943	7,0	46,0	15,7	23,0		1
05004952001	192950	8,0	46,0	17,0	23,0		1
05004953001	192967	9,0	46,0	18,2	23,0		1
05004954001	192974	10,0	46,0	19,4	23,0		1
05004955001	192981	11,0	46,0	20,7	23,0		1
05004956001	192998	12,0	46,0	23,0	23,0		1
05004957001	193001	13,0	46,0	23,0	23,0		1
05004958001	193018	14,0	46,0	24,7	23,0		1
05004959001	193025	15,0	46,0	26,0	23,0		1
05004960001	193032	16,0	46,0	26,8	23,0		1
05004961001	193049	17,0	46,0	29,0	23,0		1
05004962001	193056	18,0	46,0	29,6	23,0		1
05004963001	193063	19,0	46,0	30,7	23,0		1

### 8767 B VDE HF TORX® Zyklop bit socket, insulated, with holding function, $\frac{3}{8}$ " drive

- The holding function holds screws securely on the tool
- Extremely short and compact  $\frac{3}{8}$ " bit socket for easy work even in very confined spaces

### 8767 B VDE HF TORX® Zyklop bit socket, insulated, with holding function, $\frac{3}{8}$ " drive



	EAN						
Code	4013288		mm	mm	mm		
05004920001	210173	TX 20	55,0	23,0	9,0		1
05004921001	210180	TX 25	55,0	23,0	9,0		1
05004922001	210197	TX 27	55,0	23,0	9,0		1
05004923001	210203	TX 30	55,0	23,0	9,0		1
05004924001	210210	TX 40	55,0	23,0	9,0		1
05004925001	210227	TX 45	59,0	23,0	13,0		1

### 8740 B VDE HF Zyklop Hex bit socket, insulated, with holding function, $\frac{3}{8}$ " drive

- The holding function holds screws securely on the tool
- Extremely short and compact  $\frac{3}{8}$ " bit socket for easy work even in very confined spaces

### 8740 B VDE HF Zyklop Hex bit socket, insulated, with holding function, $\frac{3}{8}$ " drive



	EAN						
Code	4013288	mm	mm	mm	mm		
05004900001	210135	4,0	55,0	23,0	9,0		1
05004901001	210142	5,0	55,0	23,0	9,0		1
05004902001	210159	6,0	55,0	23,0	9,0		1
05004903001	210166	8,0	59,0	23,0	13,0		1

### 8760 B VDE XZN Zyklop bit socket, insulated, $\frac{3}{8}$ " drive, for multi-point socket screws

- Extremely short and compact  $\frac{3}{8}$ " bit socket for easy work even in very confined spaces

### 8760 B VDE XZN Zyklop bit socket, insulated, $\frac{3}{8}$ " drive, for multi-point socket screws



	EAN						
Code	4013288		mm	mm	mm		
05004940001	211453	M 8	59,0	23,0	13,0		1
05004941001	211460	M 10	59,0	23,0	13,0		1
05004942001	211477	M 12	59,0	23,0	13,0		1



### 8794 LB VDE Zyklop extension, insulated, long, 3/8"

- 3/8" VDE Zyklop extension
- Individually tested tool as per IEC 60900 at 10,000 V
- Increased safety due to 2-component isolation with yellow insulation core under red insulation outer layer
- Plastic coating protects surfaces from damage
- Long version

### 8794 LB VDE Zyklop extension, insulated, long, 3/8"



	EAN							
<b>Code</b>	4013288		mm					
05004965001	190956	3/8"	166,0					1

### 8794 SB VDE Zyklop extension, insulated, short, 3/8"

- Short version

### 8794 SB VDE Zyklop extension, insulated, short, 3/8"



	EAN							
<b>Code</b>	4013288		mm					
05004964001	190949	3/8"	91,0					1

### Socket rail B VDE (textile belt), 10 location, unloaded

- Empty textile belt for 10 VDE socket wrench/bit socket inserts, 3/8"
- Includes a convenient snap hook
- Smooth Twist to Unlock mechanism for a secure fit and simple removal of the sockets
- Suitable for attachment to a wall, shelf, tool trolley and to the Wera 2go System



### Socket rail B VDE (textile belt), 10 location, unloaded



Code	EAN		
05003982001	4013288		1
	210913	<b>Belt B VDE 0/10</b> 1x 71,0x209,0	
		<b>K30</b> 1x 30,0x200,0	

### 6004 Joker VDE 4 Set 1 VDE-insulated self-setting spanner set

Individually tested tools as per IEC 60900 at 10,000 V for safe working at the approved voltage of 1.000 V. The adjustable VDE spanner continuously and automatically grips all hexagonal sizes in the indicated range of dimensions - metric and imperial.

The integrated lever mechanism securely clamps the hexagon screw or bolt between the jaws, which significantly reduces the risk of slippage or damage. The ratchet feature ensures fast and consistent screwdriving without removing the tool.

By using the corner-width rectangular prisms, a back-pivoting angle of only 30° can be achieved. The single-arm design, in conjunction with the ratchet feature and the corner-width prism, makes it possible to work even in confined spaces.

The adjustable Joker 6004 VDE has a naturally comfortable handle thanks to the 2-component plastic insulation.

Safety is increased by the anti-slip protection at the front end of the handle. The sliding function offers contactless and safe opening of the non-insulated jaws, thereby providing extra protection.

- The compact textile box with four adjustable Joker 6004 VDE covers all metric and imperial dimensions in the field of application from 7 to 19 mm or ¼" to ¾"

### 6004 Joker VDE 4 Set 1 VDE-insulated self-setting spanner set

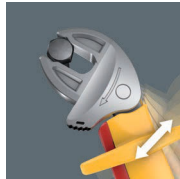

Code	EAN		
05020170001	221803		1
		<b>6004 Joker VDE XS</b> 1x 7-10 (¼"-⅜")x119	
		<b>6004 Joker VDE S</b> 1x 10-13 (⅜"-½")x155	
		<b>6004 Joker VDE M</b> 1x 13-16 (½"-⅝")x190	
		<b>6004 Joker VDE L</b> 1x 16-19 (⅝"-¾")x226	
		<b>Hook and Loop Fastener Strip 120</b> 1x 50,0x120,0	

### 6004 Joker VDE VDE-insulated, self-setting spanner

Individually tested tools as per IEC 60900 at 10,000 V for safe working at the approved voltage of 1.000 V. The adjustable VDE spanner continuously and automatically grips all hexagonal sizes in the indicated range of dimensions – metric and imperial.

The integrated lever mechanism securely clamps the hexagon screw or bolt between the jaws, which significantly reduces the risk of slippage or damage.

The ratchet feature ensures fast and consistent screwdriving without removing the tool. By using the corner-width rectangular prisms, a back-pivoting angle of only 30° can be achieved.

The single-arm design, in conjunction with the ratchet feature and the corner-width prism, makes it possible to work even in confined spaces.

The adjustable Joker 6004 VDE has a naturally comfortable handle thanks to the 2-component plastic insulation. Safety is increased by the anti-slip protection at the front end of the handle.

The sliding function offers contactless and safe opening of the non-insulated jaws, thereby providing extra protection.

- The adjustable Joker 6004 VDE covers all metric and imperial dimensions in the respective field of application
- Individually tested tools with insulated handles for safe working up to 1,000 volt, with anti-slip protection and sliding function for contactless and safe opening of the non-insulated jaws
- Automatic and continuous grip of hexagon screws and bolts
- Lever mechanism when gripping avoids slipping and damage
- Fast and consistent screwdriving without removing the wrench thanks to mechanical ratchet function
- Return angle of only 30° through placement in the corner-width rectangular prisms in the mouth

### 6004 Joker VDE XS VDE-insulated, self-setting spanner

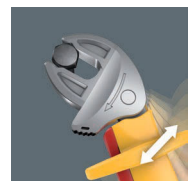

Code	EAN	mm	mm	mm		
05020150001	221797	7-10	¼"-⅜"	119	7,7	3

### 6004 Joker VDE S VDE-insulated, self-setting spanner



Code	EAN	mm	mm	mm		
05020151001	221766	10-13	7/16"-1/2"	155	10	3

### 6004 Joker VDE M VDE-insulated, self-setting spanner



Code	EAN	mm	mm	mm		
05020152001	221780	13-16	1/2"-5/8"	190	12,4	3

### 6004 Joker VDE L VDE-insulated self-setting spanner

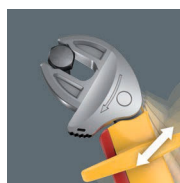

Code	EAN	mm	mm	mm		
05020153001	221773	16-19	5/8"-3/4"	226	14	3

### 400 i VDE Hex Insulated torque-indicator

Wera VDE torque indicator with fixed torque for hexagon socket screws. Tamper proof. The robust slip clutch generates a clearly audible and tactile trigger that signals when the set torque is reached, making it impossible to apply any further torque. The loosening torque value is significantly higher than the set tightening torque, therefore no additional tools are needed for loosening screw connections. The shape of the handle perfectly fills the whole hand and fingers comfortably lie in the softly rounded recessed grips. This ensures optimal, ergonomic power transfer. Individually tested tool as per IEC 60900 at 10,000 V for safe working at the approved voltage of 1,000 V.



- Insulated, individually tested VDE T-handle torque indicator for safe working up to 1,000V
- T-handle is ideal for transferring controlled tightening torque and high loosening torque
- Error-free screwdriving due to non-slip friction clutch and exact torque transmission
- Distinctly audible and noticeable excess-load signal when the pre-set torque is reached
- Tamper-proof against accidental changing of set torque value

### 400 i VDE Hex Insulated torque-indicator

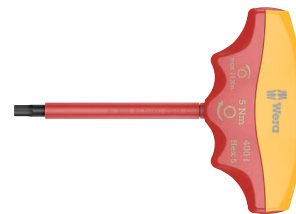

Code	EAN	mm	Nm	mm	mm	mm	mm	
05004980001	206398	4,0	5,0	90	48	100	3 1/2"	1
05004981001	206114	5,0	5,0	90	48	100	3 1/2"	1





# Ratchets & Accessories

## Zyklop Speed - incredibly fast and incredibly flexible

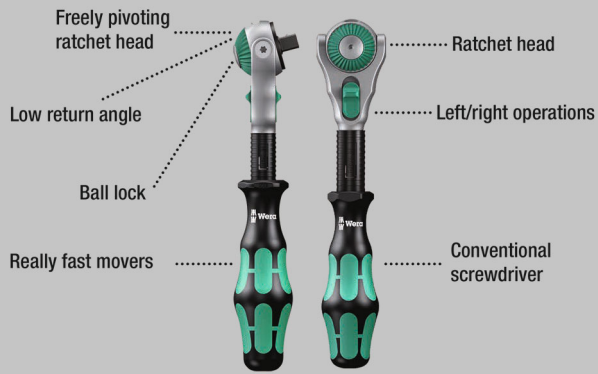

Incredibly compact set arrangement with many tools in a minimum of space. A completely new ratchet set feeling thanks to the unique textile boxes that are very robust and durable.

They can be positioned upright for tidy storage on the workshop shelf. Additional surface protection due to textile outer material. Low weight and volume for simpler mobility. Take it easy Tool Finder with colour coding according to sizes.

- 42-piece ratchet set in robust textile box
- Freely pivoting ratchet head with 5 predefined locking positions
- Bit-sockets with all the advantages of the Wera bit technology
- TORX®, hex plus and hexagon nuts with holding function for screws / nuts
- Take it easy tool finder with colour coding according to sizes
- Suitable for Wera 2go

## 8100 SA All-in Zyklop Speed Ratchet Set, 1/4" drive, with holding function, metric



Code	EAN		
05003755001	4013288 190994		1
		8000 A 1x 1/4"x152,0	
		8796 LA 1x 1/4"x150,0	
		8794 A 1x 1/4"x56,0	
		8790 HMA HF 1x 4,0x23,0; 1x 4,5x23,0; 1x 5,0x23,0; 1x 5,5x23,0; 1x 6,0x23,0; 1x 7,0x23,0; 1x 8,0x23,0; 1x 9,0x23,0; 1x 10,0x23,0; 1x 11,0x23,0; 1x 12,0x23,0; 1x 13,0x23,0; 1x 14,0x23,0	
		8767 A HF 1x TX 8x28,0; 1x TX 9x28,0; 1x TX 10x28,0; 1x TX 15x28,0; 1x TX 20x28,0; 1x TX 25x28,0; 1x TX 27x28,0; 1x TX 30x28,0; 1x TX 40x28,0	
		8740 A 1x 2,0x28,0; 1x 2,5x28,0	
		8740 A HF 1x 3,0x28,0; 1x 4,0x28,0; 1x 5,0x28,0; 1x 6,0x28,0; 1x 7,0x28,0; 1x 8,0x28,0	
		8751 A 1x PH 1x28,0; 1x PH 2x28,0; 1x PH 3x28,0	
		8755 A 1x PZ 1x28,0; 1x PZ 2x28,0; 1x PZ 3x28,0	
		8700 A FL 1x 0,8x5,5x28,0; 1x 1,2x6,5x28,0	
		Nut Extractor 1x 14,0x43,0	
		Hook and Loop Fastener Strip 120 1x 50,0x120,0	

### 8100 SA 6 Zyklop Speed Ratchet Set, 1/4" drive, metric

- Freely pivoting ratchet head with 5 predefined locking positions
- Fine toothing with 72 teeth
- Small return angle of only 5°
- Free-turning sleeve for high working speeds
- Take it easy tool finder with colour coding according to sizes
- Compact textile box with high robustness, low weight and volume

### 8100 SA 6 Zyklop Speed Ratchet Set, 1/4" drive, metric



Code	EAN		
05004016001	174000		1
		□ 8000 A 1x 1/4"x152,0	
		● 8790 HMA 1x 5,0x23,0; 1x 5,5x23,0; 1x 6,0x23,0; 1x 7,0x23,0; 1x 8,0x23,0; 1x 10,0x23,0; 1x 11,0x23,0; 1x 12,0x23,0; 1x 13,0x23,0	
		■ 8794 LA 1x 1/4"x150,0	
		■ 8794 A 1x 1/4"x56,0	
		● 8784 A1 1x 1/4"x1/4"x37,0	
		+ 851/4 TZ PH 1x PH 1x50; 1x PH 2x50; 1x PH 3x50	
		+ 855/4 TZ PZ 1x PZ 1x50; 1x PZ 2x50	
		* 867/4 Z TORX® 1x TX 10x50; 1x TX 15x50; 1x TX 20x50; 1x TX 25x50; 1x TX 27x50; 1x TX 30x50	
		○ 840/4 Z Hex-Plus 1x 3,0x50; 1x 4,0x50; 1x 5,0x50; 1x 6,0x50	
		Hook and Loop Fastener Strip 120 1x 50,0x120,0	

### 8100 SA 9 Zyklop Speed Ratchet Set, 1/4" drive, imperial



Code	EAN		
05004019001	173843		1
		□ 8000 A 1x 1/4"x152,0	
		● 8790 HMA 1x 3/16"x23,0; 1x 7/32"x23,0; 1x 1/4"x23,0; 1x 9/32"x23,0; 1x 5/16"x23,0; 1x 11/32"x23,0; 1x 3/8"x23,0; 1x 7/16"x23,0; 1x 1/2"x23,0	
		■ 8794 LA 1x 1/4"x150,0	
		■ 8794 A 1x 1/4"x56,0	
		● 8784 A1 1x 1/4"x1/4"x37,0	
		+ 851/4 TZ PH 1x PH 1x50; 1x PH 2x50; 1x PH 3x50	
		+ 855/4 TZ PZ 1x PZ 1x50; 1x PZ 2x50	
		* 867/4 Z TORX® 1x TX 10x50; 1x TX 15x50; 1x TX 20x50; 1x TX 25x50; 1x TX 27x50; 1x TX 30x50	
		○ 840/4 Z Hex-Plus 1x 5/32"x50; 1x 3/16"x50; 1x 7/32"x50; 1x 1/4"x50	
		Hook and Loop Fastener Strip 120 1x 50,0x120,0	

### Kraftform Kompakt Zyklop MS1 Metal/Speed 1/4"

- Incredibly fast 1/4" Zyklop Speed ratchet with pivoting ratchet head and 5 predefined locking positions
- Extremely slim Zyklop Metal ratchet with long lever
- Return angle of only 5°
- Convenient direction change thanks to switchover lever
- Set in robust textile box

### Kraftform Kompakt Zyklop MS1 Metal/Speed 1/4"



Code	EAN		
05135949001	4013288 178633		1
		<input type="checkbox"/> 8000 A 1x 1/4"x152,0	
		<input type="checkbox"/> 8004 A 1x 1/4"x141,0	
		<input checked="" type="checkbox"/> <input type="checkbox"/> 8796 LA 1x 1/4"x150,0	
		<input checked="" type="checkbox"/> <input type="checkbox"/> 8794 LA 1x 1/4"x150,0	
		<input checked="" type="checkbox"/> <input type="checkbox"/> 8794 SA 1x 1/4"x75,0	
		<input checked="" type="checkbox"/> <input type="checkbox"/> 8784 A1 1x 1/4"x1/4"x37,0	
		<input checked="" type="checkbox"/> <input type="checkbox"/> 8794 A 1x 1/4"x56,0	
		<input checked="" type="checkbox"/> <input type="checkbox"/> 8795 A 1x 1/4"x35,5	

### 8100 SA 2 Zyklop Speed Ratchet Set, 1/4" drive, metric

- 42-piece set in a robust metal case

### 8100 SA 2 Zyklop Speed Ratchet Set, 1/4" drive, metric



Code	EAN		
05003533001	4013288 121103		1
		<input type="checkbox"/> 8000 A 1x 1/4"x152,0	
		<input checked="" type="checkbox"/> 8790 HMA 1x 4,0x23,0; 1x 4,5x23,0; 1x 5,0x23,0; 1x 5,5x23,0; 1x 6,0x23,0; 1x 7,0x23,0; 1x 8,0x23,0; 1x 9,0x23,0; 1x 10,0x23,0; 1x 11,0x23,0; 1x 12,0x23,0; 1x 13,0x23,0; 1x 14,0x23,0	
		<input type="checkbox"/> 8789 A 1x 1/4"x110,0	
		<input checked="" type="checkbox"/> <input type="checkbox"/> 8794 A 1x 1/4"x56,0	
		<input checked="" type="checkbox"/> <input type="checkbox"/> 8795 A 1x 1/4"x35,5	
		<input checked="" type="checkbox"/> <input type="checkbox"/> 8784 A1 1x 1/4"x1/4"x37,0	
		<input checked="" type="checkbox"/> <input type="checkbox"/> 8796 SA 1x 1/4"x75,0	
		<input checked="" type="checkbox"/> <input type="checkbox"/> 8796 LA 1x 1/4"x150,0	
		<input checked="" type="checkbox"/> 851/1 Z PH 1x PH 1x25; 1x PH 2x25; 1x PH 3x25	
		<input checked="" type="checkbox"/> 855/1 Z PZ 1x PZ 1x25; 1x PZ 2x25; 1x PZ 3x25	
		<input checked="" type="checkbox"/> 867/1 Z TORX® B0 1x TX 8x25; 1x TX 9x25; 1x TX 10x25; 1x TX 15x25; 1x TX 20x25; 1x TX 25x25; 1x TX 30x25; 1x TX 40x25	
		<input type="checkbox"/> 840/1 Z Hex-Plus 1x 3,0x25; 1x 4,0x25; 1x 5,0x25; 1x 6,0x25; 1x 8,0x25	
		<input checked="" type="checkbox"/> 800/1 Z 1x 0,6x4,5x25; 1x 1,0x5,5x25; 1x 1,2x8,0x25	



## 8100 SA 4 Zyklop Speed Ratchet Set, 1/4" drive, imperial

- 41-piece set in a robust metal case

### 8100 SA 4 Zyklop Speed Ratchet Set, 1/4" drive, imperial



Code	EAN			
05003535001	4013288 121127			1
		□	<b>8000 A</b> 1x 1/4"x152,0	
		●	<b>8790 HMA</b> 1x 3/16"x23,0; 1x 7/32"x23,0; 1x 1/4"x23,0; 1x 9/32"x23,0; 1x 5/16"x23,0; 1x 11/32"x23,0; 1x 3/8"x23,0; 1x 7/16"x23,0; 1x 1/2"x23,0; 1x 9/16"x23,0	
		□	<b>8789 A</b> 1x 1/4"x110,0	
		□	<b>8794 A</b> 1x 1/4"x56,0	
		□	<b>8795 A</b> 1x 1/4"x35,5	
		□	<b>8784 A1</b> 1x 1/4"x1/4"x37,0	
		□	<b>8796 SA</b> 1x 1/4"x75,0	
		□	<b>8796 LA</b> 1x 1/4"x150,0	
		+	<b>851/1 Z PH</b> 1x PH 1x25; 1x PH 2x25; 1x PH 3x25	
		+	<b>855/1 Z PZ</b> 1x PZ 1x25; 1x PZ 2x25; 1x PZ 3x25	
		+	<b>867/1 Z TORX® BO</b> 1x TX 8x25; 1x TX 9x25; 1x TX 10x25; 1x TX 15x25; 1x TX 20x25; 1x TX 25x25; 1x TX 30x25; 1x TX 40x25	
		○	<b>840/1 Z Hex-Plus</b> 1x 5/64"x25; 1x 3/32"x25; 1x 1/8"x25; 1x 9/64"x25; 1x 5/32"x25; 1x 3/16"x25; 1x 7/32"x25	
		○	<b>800/1 Z</b> 1x 0,6x4,5x25; 1x 1,0x5,5x25; 1x 1,2x8,0x25	

## 8100 SA/SC 2 Zyklop Speed Ratchet Set, 1/4" drive and 1/2" drive, metric

- 43-piece set in a robust metal case

### 8100 SA/SC 2 Zyklop Speed Ratchet Set, 1/4" drive and 1/2" drive, metric



Code	EAN			
05160785001	4013288 126610			1
		□	<b>8000 A</b> 1x 1/4"x152,0	
		●	<b>8790 HMA</b> 1x 4,0x23,0; 1x 4,5x23,0; 1x 5,0x23,0; 1x 5,5x23,0; 1x 6,0x23,0; 1x 7,0x23,0; 1x 8,0x23,0; 1x 9,0x23,0; 1x 10,0x23,0; 1x 12,0x23,0; 1x 13,0x23,0	
		□	<b>8784 A1</b> 1x 1/4"x1/4"x37,0	
		□	<b>8796 LA</b> 1x 1/4"x150,0	
		□	<b>8000 C</b> 1x 1/2"x277,0	
		●	<b>8790 HMC</b> 1x 13,0x37,0; 1x 14,0x37,0; 1x 15,0x37,0; 1x 16,0x37,0; 1x 17,0x37,0; 1x 18,0x37,0; 1x 19,0x37,0; 1x 21,0x37,0; 1x 22,0x37,0; 1x 24,0x37,0	
		□	<b>8796 LC</b> 1x 1/2"x250,0	
		●	<b>816 R</b> 1x 1/4"x119	
		○	<b>800/4 Z</b> 1x 1,0x5,5x89	
		○	<b>840/4 Z Hex-Plus</b> 1x 3,0x89; 1x 4,0x89; 1x 5,0x89; 1x 6,0x89	
		+	<b>851/4 Z PH</b> 1x PH 1x89; 1x PH 2x89; 1x PH 3x89	
		+	<b>855/4 Z PZ</b> 1x PZ 1x89; 1x PZ 2x89; 1x PZ 3x89	
		+	<b>867/4 Z TORX® BO</b> 1x TX 10x89; 1x TX 15x89; 1x TX 20x89; 1x TX 25x89; 1x TX 30x89	

## Kraftform Kompakt Zyklop Speed

- Pouch for belt attachment

### Kraftform Kompakt Zyklop Speed



Code	EAN			
0500350001	121868	1/4"	152,0	1
Code	EAN			
05051045001	155313			1
		8000 A	1x 1/4"x152,0	
		8784 A1	1x 1/4"x1/4"x37,0	
		8794 LA	1x 1/4"x150,0	
		851/4 TZ PH	1x PH 1x50; 1x PH 2x50; 1x PH 3x50	
		855/4 TZ PZ	1x PZ 1x50; 1x PZ 2x50	
		867/4 Z TORX®	1x TX 10x50; 1x TX 15x50; 1x TX 20x50; 1x TX 25x50; 1x TX 27x50; 1x TX 30x50	
		800/4 Z	1x 1,0x5,5x50	
		840/4 Z Hex-Plus	1x 3,0x50; 1x 4,0x50; 1x 5,0x50; 1x 6,0x50	
		8790 HMA	1x 5,5x23,0; 1x 6,0x23,0; 1x 7,0x23,0; 1x 8,0x23,0; 1x 10,0x23,0; 1x 12,0x23,0; 1x 13,0x23,0	
		Hook and Loop Fastener Strip 70	1x 50,0x70,0	

## 8000 A Zyklop Speed Ratchet with 1/4" drive

- Combines five different types of a ratchet in one
- Flywheel design and easy-to-grip free-turning sleeve for very high working speeds
- Freely pivoting ratchet head, push button release and left/right switchover
- Fine-tooth design allows a small return angle of 5°
- Can also be used as a screwdriver

### 8000 A Zyklop Speed Ratchet with 1/4" drive



Code	EAN						
0500350001	121868	1/4"	152,0				1

### 8000 A SB Zyklop Speed Ratchet with 1/4" drive



Code	EAN						
05073260001	128034	8000 A	1x 1/4"x152,0				3

## Zyklop Metal with push-through square

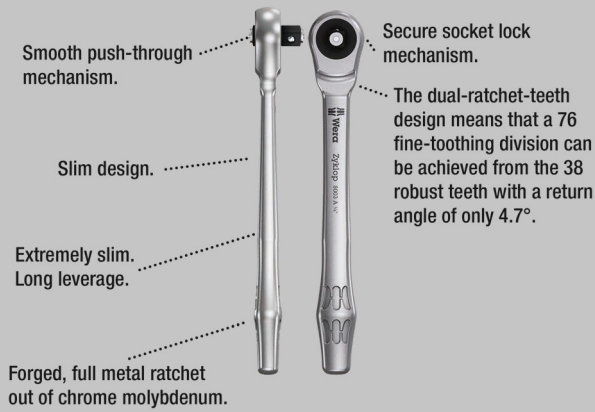

Incredibly compact set arrangement with many tools in a minimum of space. A completely new ratchet set feeling thanks to the unique textile boxes that are very robust and durable. They can be positioned upright for tidy storage on the workshop shelf. Additional surface protection due to textile outer material. Low weight and volume for simpler mobility.

Take it easy Tool Finder with colour coding according to sizes.

- Extremely slim ratchet with long lever
- Return angle of only 4.7°
- Absolutely smooth switchover of the non-detachable push-through square
- Take it easy tool finder system

## 8100 SA 7 Zyklop Metal Ratchet Set with push-through square, 1/4" drive, metric



Code	EAN			
05004017001	4013288 173898			1
		□	<b>8003 A</b> 1x 1/4"x141,0	
		●	<b>8790 HMA</b> 1x 5,0x23,0; 1x 5,5x23,0; 1x 6,0x23,0; 1x 7,0x23,0; 1x 8,0x23,0; 1x 10,0x23,0; 1x 11,0x23,0; 1x 12,0x23,0; 1x 13,0x23,0	
		□	<b>8794 LA</b> 1x 1/4"x150,0	
		□	<b>8794 A</b> 1x 1/4"x56,0	
		●	<b>8784 A1</b> 1x 1/4"x1/4"x37,0	
		+	<b>851/1 Z PH</b> 1x PH 1x25; 1x PH 2x25; 1x PH 3x25	
		+	<b>855/1 Z PZ</b> 1x PZ 1x25; 1x PZ 2x25	
		✦	<b>867/1 TORX®</b> 1x TX 10x25; 1x TX 15x25; 1x TX 20x25; 1x TX 25x25; 1x TX 27x25; 1x TX 30x25	
		○	<b>840/1 Z Hex-Plus</b> 1x 3,0x25; 1x 4,0x25; 1x 5,0x25; 1x 6,0x25	

## 8100 SA 10 Zyklop Metal Ratchet Set with push-through square, 1/4" drive, imperial



Code	EAN			
05004020001	4013288 173904			1
		□	<b>8003 A</b> 1x 1/4"x141,0	
		●	<b>8790 HMA</b> 1x 3/16"x23,0; 1x 7/32"x23,0; 1x 1/4"x23,0; 1x 9/32"x23,0; 1x 5/16"x23,0; 1x 11/32"x23,0; 1x 3/8"x23,0; 1x 7/16"x23,0; 1x 1/2"x23,0	
		□	<b>8794 LA</b> 1x 1/4"x150,0	
		□	<b>8794 A</b> 1x 1/4"x56,0	
		●	<b>8784 A1</b> 1x 1/4"x1/4"x37,0	
		+	<b>851/1 Z PH</b> 1x PH 1x25; 1x PH 2x25; 1x PH 3x25	
		+	<b>855/1 Z PZ</b> 1x PZ 1x25; 1x PZ 2x25	
		✦	<b>867/1 TORX®</b> 1x TX 10x25; 1x TX 15x25; 1x TX 20x25; 1x TX 25x25; 1x TX 27x25; 1x TX 30x25	
		○	<b>840/1 Z Hex-Plus</b> 1x 5/32"x25; 1x 3/16"x25; 1x 7/32"x25; 1x 1/4"x25	

### 8003 A Zyklop Metal Ratchet with push-through square and 1/4" drive

- For 1/4" square sockets with ball lock
- Forged, full metal ratchet (chrome-molybdenum); slim design to enable work in very confined spaces
- The dual-ratchet-teeth design means that a 76 fine-toothing division can be achieved from the 38 robust teeth with a return angle of only 4.7°
- Absolutely smooth switchover of the non-detachable push-through square

### 8003 A Zyklop Metal Ratchet with push-through square and 1/4" drive



Code	EAN	Drive	Length	Width	Height	Weight	Volume
05004003001	174017	1/4"	141,0	21	22		3

### Zyklop Metal with switch lever

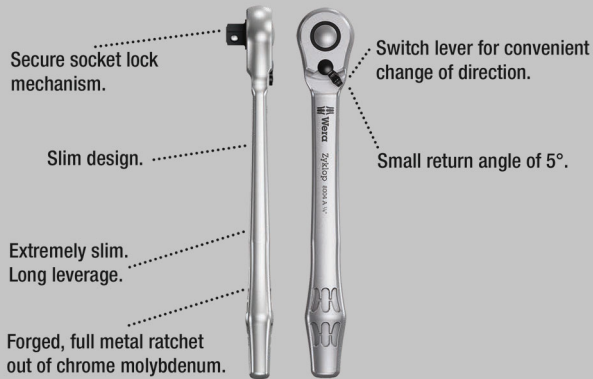

Incredibly compact set arrangement with many tools in a minimum of space. A completely new ratchet set feeling thanks to the unique textile boxes that are very robust and durable.

They can be positioned upright for tidy storage on the workshop shelf. Additional surface protection due to textile outer material. Low weight and volume for simpler mobility.

Take it easy Tool Finder with colour coding according to sizes.

- Convenient direction change thanks to switchover lever
- Extremely slim ratchet with long lever
- Return angle of only 5°

### 8100 SA 8 Zyklop Metal Ratchet Set with switch lever, 1/4" drive, metric



Code	EAN	Content	Volume
05004018001	173836	8004 A 1x 1/4"x141,0	1
		8790 HMA 1x 5,0x23,0; 1x 5,5x23,0; 1x 6,0x23,0; 1x 7,0x23,0; 1x 8,0x23,0; 1x 10,0x23,0; 1x 11,0x23,0; 1x 12,0x23,0; 1x 13,0x23,0	
		8794 LA 1x 1/4"x150,0	
		8794 A 1x 1/4"x56,0	
		8784 A1 1x 1/4"x1/4"x37,0	
		851/1 Z PH 1x PH 1x25; 1x PH 2x25; 1x PH 3x25	
		855/1 Z PZ 1x PZ 1x25; 1x PZ 2x25	
		867/1 TORX® 1x TX 10x25; 1x TX 15x25; 1x TX 20x25; 1x TX 25x25; 1x TX 27x25; 1x TX 30x25	
		840/1 Z Hex-Plus 1x 3,0x25; 1x 4,0x25; 1x 5,0x25; 1x 6,0x25	
		Hook and Loop Fastener Strip 120 1x 50,0x120,0	

### 8100 SA 11 Zyklop Metal Ratchet Set with switch lever, 1/4" drive, imperial



Code	EAN			
05004021001	173850			1
		8004 A	1x 1/4"x141,0	
		8790 HMA	1x 3/16"x23,0; 1x 7/32"x23,0; 1x 1/4"x23,0; 1x 9/32"x23,0; 1x 5/16"x23,0; 1x 11/32"x23,0; 1x 3/8"x23,0; 1x 7/16"x23,0; 1x 1/2"x23,0	
		8794 LA	1x 1/4"x150,0	
		8794 A	1x 1/4"x56,0	
		8784 A1	1x 1/4"x1/4"x37,0	
		851/1 Z PH	1x PH 1x25; 1x PH 2x25; 1x PH 3x25	
		855/1 Z PZ	1x PZ 1x25; 1x PZ 2x25	
		867/1 TORX®	1x TX 10x25; 1x TX 15x25; 1x TX 20x25; 1x TX 25x25; 1x TX 27x25; 1x TX 30x25	
		840/1 Z Hex-Plus	1x 3/32"x25; 1x 3/16"x25; 1x 7/32"x25; 1x 1/4"x25	

### 8100 SA 12 HF Zyklop Metal Ratchet Set with switch lever, 1/4" drive, metric

- Sockets with holding function for screws/bolts/nuts

### 8100 SA 12 HF Zyklop Metal Ratchet Set with switch lever, 1/4" drive, metric



Code	EAN			
05003756001	190987			1
		8004 A	1x 1/4"x141	
		8794 LA	1x 1/4"x150,0	
		8794 A	1x 1/4"x56,0	
		8790 HMA HF	1x 5,0x23,0; 1x 5,5x23,0; 1x 6,0x23,0; 1x 7,0x23,0; 1x 8,0x23,0; 1x 10,0x23,0; 1x 11,0x23,0; 1x 12,0x23,0; 1x 13,0x23,0	
		Nut Extractor	1x 14,0x43,0	
		Hook and Loop Fastener Strip 120	1x 50,0x120,0	

### 8004 A Zyklop Metal Ratchet with switch lever and 1/4" drive

- Convenient direction change thanks to switchover lever
- Extremely slim ratchet with long lever
- Return angle of only 5°
- Secure socket locking

### 8004 A Zyklop Metal Ratchet with switch lever and 1/4" drive



Code	EAN						
05004004001	174024	1/4"	141,0	19	22		3

## 8790 HMA Zyklop 1/4" socket

- 1/4" Zyklop socket
- For manual and power tool operations (non-impact)
- Knurling at lower end to enable easy gripping when used in manual applications
- Equipped with ball stop groove
- Take it easy tool finder with colour coding according to sizes

### 8790 HMA Zyklop 1/4" socket



Code	EAN		mm	mm	mm	mm		
05003501001	120083		4,0	23,0	6,9	13,0	1	
05003502001	120106		4,5	23,0	7,5	13,0	1	
05003503001	120113		5,0	23,0	8,2	13,0	1	
05003504001	120120		5,5	23,0	8,8	13,0	1	
05003505001	120137		6,0	23,0	9,4	13,0	1	
05003506001	120144		7,0	23,0	11,0	13,0	1	
05003507001	120151		8,0	23,0	12,0	13,0	1	
05003508001	120090		9,0	23,0	13,0	14,0	1	
05003509001	120168		10,0	23,0	14,5	14,5	1	
05003510001	120175		11,0	23,0	16,0	15,0	1	
05003511001	120182		12,0	23,0	17,0	16,0	1	
05003512001	120199		13,0	23,0	18,0	17,0	1	
05003513001	120205		14,0	23,0	20,0	18,0	1	
05003499001	206862		15,0	23,0	21,5	19,0	1	
05003514001	120212			3/16"	23,0	7,5	13,0	1
05003515001	120229			7/32"	23,0	8,8	13,0	1
05003516001	120236			1/4"	23,0	11,0	13,0	1
05003517001	120243			9/32"	23,0	11,0	13,0	1
05003518001	120250			5/16"	23,0	12,0	13,0	1
05003519001	120267			11/32"	23,0	13,0	14,0	1
05003520001	120274			3/8"	23,0	14,5	14,5	1
05003521001	120281			7/16"	23,0	16,0	15,0	1
05003522001	120298			1/2"	23,0	18,0	17,0	1
05003523001	120304			9/16"	23,0	20,0	18,0	1

## 8790 HMA HF Zyklop socket with 1/4" drive with holding function

- Socket (non-impact) for manual or power tool operations
- The holding function holds screws securely on the tool
- Take it easy tool finder with colour coding according to sizes
- Chrome vanadium steel, matt chrome-plated
- Equipped with ball stop groove, knurling at lower end for better gripping

### 8790 HMA HF Zyklop socket with 1/4" drive with holding function



Code	EAN		mm	mm	mm	mm	
05003717001	185631		4,0	23,0	7,0	11,0	1
05003718001	185648		4,5	23,0	7,8	11,0	1
05003719001	185655		5,0	23,0	8,9	11,0	1
05003720001	185662		5,5	23,0	9,2	11,0	1
05003721001	185679		6,0	23,0	10,5	11,0	1
05003722001	185686		7,0	23,0	11,9	11,0	1
05003723001	185693		8,0	23,0	12,9	11,0	1
05003724001	185709		9,0	23,0	14,1	12,0	1
05003725001	185716		10,0	23,0	15,6	12,5	1
05003726001	185723		11,0	23,0	17,4	13,0	1
05003727001	185730		12,0	23,0	18,4	14,0	1
05003728001	185747		13,0	23,0	19,5	15,0	1
05003729001	185754		14,0	23,0	20,8	16,0	1
05003010001	206855		15,0	23,0	21,5	18,5	1

### Belt A 1 Zyklop socket set with holding function, 1/4" drive

Typically Wera designed robust textile belt with 9 sockets taking up minimal space. A smooth Twist to Unlock mechanism ensures a secure fit and simple removal of the sockets.

Comes with Take it easy Tool Finder with colour coding according to size to enable the right tool to be selected easily and quickly. Includes a snap hook for secure fastening to a belt loop or pocket.

Sockets with holding function for particularly convenient screw-driving with reduced risk of losing the screw when approaching the workpiece.

Supplied with a non-woven reverse side and hook and loop strips for simple attachment e.g. to a wall, shelf, tool trolley and to the Wera 2go tool transport system.

- 10-piece socket set on a robust textile belt, 1/4"
- Sockets with holding function for screws/bolts/nuts
- Smooth Twist to Unlock mechanism for a secure fit and simple removal of the sockets
- Take it easy tool finder with colour coding according to sizes
- Suitable for attachment to a wall, shelf, tool trolley and to the Wera 2go System

### Belt A 1 Zyklop socket set with holding function, 1/4" drive



Code	EAN		
05003880001	4013288 190758		1
		● <b>8790 HMA HF</b> 1x 4,0x23,0; 1x 4,5x23,0; 1x 5,0x23,0; 1x 5,5x23,0; 1x 6,0x23,0; 1x 7,0x23,0; 1x 8,0x23,0; 1x 10,0x23,0; 1x 13,0x23,0	
		<b>Nut Extractor</b> 1x 14,0x43,0	
		<b>Belt A 0/9</b> 1x 39,0x238,0	
		<b>Hook and Loop Fastener Strip 30</b> 1x 30,0x200,0	

### Nut Extractor

- Simple removal of nuts contained within Wera HF sockets
- For the simple removal of nuts from 1/4", 3/8", 1/2" sockets with holding function
- Hexagonal anti-roll feature against rolling away

### Nut Extractor



	EAN							
Code	4013288	mm	mm					
05050005001	192554	14,0	43,0					1

### Belt A 4 Zyklop socket set, 1/4" drive

- 9-piece socket set on a robust textile belt, 1/4"
- For manual and power tool operations (non-impact)
- Smooth Twist to Unlock mechanism for a secure fit and simple removal of the sockets
- Take it easy tool finder with colour coding according to sizes
- Suitable for attachment to a wall, shelf, tool trolley and to the Wera 2go System

### Belt A 4 Zyklop socket set, 1/4" drive

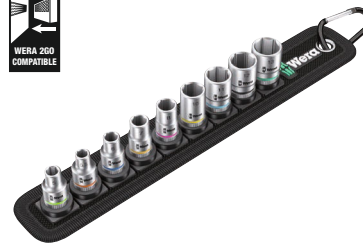

Code	EAN		
05003883001	4013288 190789		1
		● <b>8790 HMA</b> 1x 5,0x23,0; 1x 5,5x23,0; 1x 6,0x23,0; 1x 7,0x23,0; 1x 8,0x23,0; 1x 10,0x23,0; 1x 11,0x23,0; 1x 12,0x23,0; 1x 13,0x23,0	
		<b>Belt A 0/9</b> 1x 39,0x238,0	
		<b>Hook and Loop Fastener Strip 30</b> 1x 30,0x200,0	

**Magnetic socket rail A 4 Zyklop socket set, 1/4" drive**  
 Socket rail with 9 manual and machine sockets (non-impact), 1/4". A smooth rotary mechanism allows a secure hold and easy access of the sockets.

With Take it easy tool finder with colour coding by size - to help you find the required tool quickly and easily.

The rail allows temporary attachment to metallic surfaces and, with its twist-to-unlock function, ensures secure locking and unlocking of the sockets.

- 9-piece socket set on socket rail, 1/4"
- Rail with secure bit mounting and yet easy removal (twist-to-unlock) for temporary attachment on wall, shelf or workshop trolley
- Smooth Twist to Unlock mechanism for a secure fit and simple removal of the sockets
- With Take it easy tool finder: colour coding by size

**Magnetic socket rail A 4 Zyklop socket set, 1/4" drive**



Code	EAN		
05005400001	4013288 223197		1
		● <b>8790 HMA</b> 1x 5,0x23,0; 1x 5,5x23,0; 1x 6,0x23,0; 1x 7,0x23,0; 1x 8,0x23,0; 1x 10,0x23,0; 1x 11,0x23,0; 1x 12,0x23,0; 1x 13,0x23,0	
		<b>9600</b> 1x 30,0x270,0	

**Belt A Imperial 1 Zyklop In-Hex-Plus bit socket set with holding function, 1/4" drive**



Code	EAN		
05003884001	4013288 194992		1
		○ <b>8740 A</b> 1x 5/64"x28,0; 1x 3/32"x28,0; 1x 7/64"x28,0	
		○ <b>8740 A HF</b> 1x 1/8"x28,0; 1x 9/64"x28,0; 1x 5/32"x28,0; 1x 3/16"x28,0; 1x 7/32"x28,0; 1x 1/4"x28,0	
		<b>Belt A 0/9</b> 1x 39,0x238,0	
		<b>Hook and Loop Fastener Strip 30</b> 1x 30,0x200,0	

**Magnetic socket rail A Imperial 1 Zyklop socket set, 1/4" drive, imperial**

Socket rail with 9 manual and machine sockets (non-impact), 1/4". A smooth rotary mechanism allows a secure hold and easy access of the sockets.

With Take it easy tool finder with colour coding by size - to help you find the required tool quickly and easily.

The rail allows temporary attachment to metallic surfaces and, with its twist-to-unlock function, ensures secure locking and unlocking of the sockets.

- 9-piece socket set on socket rail, 1/4"
- Rail with secure bit mounting and yet easy removal (twist-to-unlock) for temporary attachment on wall, shelf or workshop trolley
- Smooth Twist to Unlock mechanism for a secure fit and simple removal of the sockets
- With Take it easy tool finder: colour coding by size

**Magnetic socket rail A Imperial 1 Zyklop socket set, 1/4" drive, imperial**

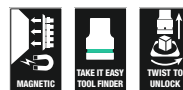

Code	EAN		
05005420001	4013288 223227		1
		● <b>8790 HMA</b> 1x 3/16"x23,0; 1x 7/32"x23,0; 1x 1/4"x23,0; 1x 9/32"x23,0; 1x 5/16"x23,0; 1x 11/32"x23,0; 1x 3/8"x23,0; 1x 7/16"x23,0; 1x 1/2"x23,0	
		<b>9600</b> 1x 30,0x270,0	



## 8790 HMA Deep 1/4" socket

Long 1/4" hand and machine socket (ISO 2725 part 3) with ball intercept ring; for external hexagonal bolts and sockets.

For use in manual and machine operation (non-impact), even with low-lying screwdriving and protruding threaded rods.

With Take it easy tool finder with colour coding by size - for easy and fast location of the required tool. Easy to grasp even with oily hands.

The hexagon profile allows the transmission of high forces and puts less strain on the edges of bolts or screw heads than a double hexagon profile.

Fine-toothed ratchets also make the use of a double hexagon profile superfluous, even in confined spaces, thanks to their small back-pivoting angle.

- Long sockets for low-lying screwdriving, often even with protruding threaded rods in small spaces
- Hexagonal profile enables precise bolting with high power transmission and preserves the profile
- Take it easy tool finder with colour coding according to sizes
- Knurling on lower end for more grip when used manually
- For manual and machine operation (non-impact), ball intercept ring
- Made of matt chromed chrome-vanadium

### 8790 HMA Deep 1/4" socket



Code	EAN		mm	mm	mm	mm	
05004500001	210258		4,0	50,0	6,7	11,8	1
05004501001	210128		5,0	50,0	8,0	11,8	1
05004502001	210241		5,5	50,0	8,6	11,8	1
05004503001	210265		6,0	50,0	9,2	11,8	1
05004504001	210272		7,0	50,0	10,8	11,8	1
05004505001	210289		8,0	50,0	11,8	11,0	1
05004506001	210296		9,0	50,0	12,8	12,0	1
05004507001	210302		10,0	50,0	14,7	12,8	1
05004508001	210319		11,0	50,0	15,8	14,0	1
05004509001	210326		12,0	50,0	16,8	15,0	1
05004510001	210333		13,0	50,0	17,8	16,0	1
05004511001	210340		14,0	50,0	19,8	17,0	1
05004512001	210357		15,0	50,0	20,8	18,0	1

## Belt A Deep 1 socket set, 1/4" drive

Robust textile belt in the typical Wera design with 9 long 1/4" manual and machine socket inserts (non-impacting) in a confined space. A smoother turning mechanism ensures a secure holding and easy removal of sockets. Includes snap hook for attaching to belt loops or bags.

With fleece backing and hook and loop fastener strips for easy attachment e.g. on wall, shelf, workshop trolley or the Wera 2go tool transport system.

Long 1/4" manual and mechanical socket wrench inserts (ISO 2725 part 3) from Wera for use in manual and machine operation (non-impacting) even with low-lying screwdriving and protruding threaded rods.

With Take it easy tool finder with colour coding by size - for easy and fast location of the required tool. Easy to grasp even with oily hands. With hexagonal profile and ball-catching groove. The hexagon profile allows the transmission of high forces and puts less strain on the edges of bolts or screw heads than a double hexagon profile.

Fine-toothed ratchets also make the use of a double hexagon profile superfluous, even in confined spaces, thanks to their small back-pivoting angle. For external hexagonal bolts and sockets.

- 9-piece socket set on a robust textile belt, 1/4"
- Smooth Twist to Unlock mechanism for a secure fit and simple removal of the sockets
- Long 1/4" socket for low-profile-fitting screw connections in tight construction spaces and for protruding threaded rods
- Hexagonal profile enables precise and profile-preserving screw-driving with high power transmission
- Take it easy tool finder with colour coding according to sizes

### Belt A Deep 1 socket set, 1/4" drive



Code	EAN		
05004525001	210371		1
		<b>8790 HMA Deep</b> 1x 5,0x50,0; 1x 5,5x50,0; 1x 6,0x50,0; 1x 7,0x50,0; 1x 8,0x50,0; 1x 10,0x50,0; 1x 11,0x50,0; 1x 12,0x50,0; 1x 13,0x50,0	
		<b>Belt A 0/9</b> 1x 39,0x238,0	
		<b>Hook and Loop Fastener Strip 30</b> 1x 30,0x200,0	

**Magnetic socket rail A Deep 1 socket set, 1/4" drive**  
 Socket rail with 9 long manual and machine sockets (non-impact), 1/4". A smooth rotary mechanism allows a secure hold and easy access of the sockets.

Long 1/4" manual and machine sockets (ISO 2725 part 3) by Wera for manual and (non-impact) machine use even at low lying couplings and protruding thread rods. With Take it easy tool finder with colour coding by size - to help you find the required tool quickly and easily.

Slip-proof for easy grip even with oily hands. With hexagon profile and ball stop groove.

The hexagon profile enables the transmission of high forces and loads the edges of the bolt or the screw head less than a double hexagon profile.

Fine-teethed ratchets also make use of a double hexagon profile superfluous, even in confined spaces, thanks to their small return angle.

For external hexagon bolts and screws. The rail allows temporary attachment to metallic surfaces and, with its twist-to-unlock function, ensures secure locking and unlocking of the sockets.

- 9-piece socket set on socket rail, 1/4"
- Rail with secure bit mounting and yet easy removal (twist-to-unlock) for temporary attachment on wall, shelf or workshop trolley
- Smooth Twist to Unlock mechanism for a secure fit and simple removal of the sockets
- Long 1/4" socket for low-profile-fitting screw connections in tight construction spaces and for protruding threaded rods
- Hexagonal profile enables precise and profile-preserving screwdriving with high power transmission

**Magnetic socket rail A Deep 1 socket set, 1/4" drive**



Code	EAN		
05005410001	223210		1
		<b>8790 HMA Deep</b> 1x 5,0x50,0; 1x 5,5x50,0; 1x 6,0x50,0; 1x 7,0x50,0; 1x 8,0x50,0; 1x 10,0x50,0; 1x 11,0x50,0; 1x 12,0x50,0; 1x 13,0x50,0	
		<b>9600</b> 1x 30,0x270,0	

**8767 A TORX® Zyklop bit socket with holding function, 1/4" drive**



	EAN							
Code	4013288			mm	mm	mm	mm	
05003390001	219602		TX 10	28,0	12,0	12,5	11,0	1
05003391001	219619		TX 20	28,0	12,0	12,5	11,0	1
05003392001	219626		TX 25	28,0	12,0	12,5	11,0	1
05003393001	219633		TX 30	28,0	12,0	12,5	11,0	1

**8767 A HF TORX® Zyklop bit socket with holding function, 1/4" drive**

- Bit socket (non-impact) for manual or machine tool operations
- The holding function holds screws securely on the tool
- Take it easy tool finder with colour coding according to sizes
- Knurling on lower end for more grip when used manually
- Chrome vanadium steel, matt chrome-plated

**8767 A HF TORX® Zyklop bit socket with holding function, 1/4" drive**



	EAN							
Code	4013288			mm	mm	mm	mm	
05003360001	186829		TX 8	28,0	12,0	12,5	11,0	1
05003361001	186843		TX 9	28,0	12,0	12,5	11,0	1
05003362001	186836		TX 10	28,0	12,0	12,5	11,0	1
05003363001	186850		TX 15	28,0	12,0	12,5	11,0	1
05003364001	186867		TX 20	28,0	12,0	12,5	11,0	1
05003365001	186874		TX 25	28,0	12,0	12,5	11,0	1
05003366001	186881		TX 25	100,0	12,0	12,5	83,0	1
05003367001	186898		TX 27	28,0	12,0	12,5	11,0	1
05003368001	186904		TX 27	100,0	12,0	12,5	83,0	1
05003369001	186911		TX 30	28,0	12,0	12,5	11,0	1
05003370001	186928		TX 30	100,0	12,0	12,5	83,0	1
05003371001	186935		TX 40	28,0	12,0	12,5	11,0	1
05003372001	186942		TX 40	100,0	12,0	12,5	83,0	1

### Belt A 3 TORX® HF Zyklop bit socket set with holding function, 1/4" drive

Typically Wera designed robust textile belt with 9 sockets taking up minimal space. A smooth Twist to Unlock mechanism ensures a secure fit and simple removal of the sockets.

Comes with Take it easy Tool Finder with colour coding according to size to enable the right tool to be selected easily and quickly. Includes a snap hook for secure fastening to a belt loop or pocket. Especially short, stable bit-sockets with all the advantages of the Wera bit technology.

Bit sockets with holding function for particularly convenient screwdriving with reduced risk of losing the screw when approaching the workpiece. Supplied with a nonwoven reverse side and hook and loop strips for simple attachment e.g. to a wall, shelf, tool trolley and to the Wera 2go tool transport system.

- 9-piece bit-socket set on a robust textile belt, 1/4"
- Bit-sockets with all the advantages of the Wera bit technology
- Bit-sockets with holding function for screws/bolts
- Smooth Twist to Unlock mechanism for a secure fit and simple removal of the sockets
- Suitable for attachment to a wall, shelf, tool trolley and to the Wera 2go System
- Take it easy tool finder with colour coding according to sizes

### Belt A 3 TORX® HF Zyklop bit socket set with holding function, 1/4" drive



Code	EAN		
05003882001	190772		1
		<b>8767 A HF</b> 1x TX 8x28,0; 1x TX 9x28,0; 1x TX 10x28,0; 1x TX 15x28,0; 1x 3,7x3,7xTX 20x28,0; 1x 4,1x4,1xTX 25x28,0; 1x 4,8x4,8xTX 27x28,0; 1x 5,4x5,4xTX 30x28,0; 1x 6,5x6,5xTX 40x28,0	
		<b>Belt A 0/9</b> 1x 39,0x238,0	
		<b>Hook and Loop Fastener Strip 30</b> 1x 30,0x200,0	

### 8767 A TORX® HF 1 Zyklop bit socket set with holding function, 1/4" drive

- Compact textile box with high robustness, low weight and volume
- Bit socket (non-impact) for manual or power tool operations
- The holding function holds screws securely on the tool
- Take it easy tool finder with colour coding according to sizes
- Knurling on lower socket end for more grip when used manually
- Long design

### 8767 A TORX® HF 1 Zyklop bit socket set with holding function, 1/4" drive



Code	EAN		
05003375001	191014		1
		<b>8767 A HF</b> 1x TX 25x100,0; 1x TX 27x100,0; 1x TX 30x100,0; 1x TX 40x100,0	
		<b>Hook and Loop Fastener Strip 70</b> 1x 50,0x70,0	

### 8740 A HF Zyklop bit socket with holding function, 1/4" drive

- Bit socket (non-impact) for manual or machine tool operations
- The holding function holds screws securely on the tool
- Hex-Plus allows socket head screws to live longer

### 8740 A HF Zyklop bit socket with holding function, 1/4" drive



Code	EAN		mm	mm	mm	mm		
05003332001	187123		3,0	28,0	12,0	12,5	1	
05003333001	187178		4,0	28,0	12,0	12,5	1	
05003334001	187185		4,0	100,0	12,0	12,5	1	
05003335001	187192		5,0	28,0	12,0	12,5	1	
05003336001	187208		5,0	100,0	12,0	12,5	1	
05003337001	187215		6,0	28,0	12,0	12,5	1	
05003338001	187222		6,0	100,0	12,0	12,5	1	
05003341001	189547		7,0	28,0	12,0	12,5	1	
05003342001	189554		7,0	100,0	12,0	12,5	1	
05003339001	187239		8,0	28,0	12,0	12,5	1	
05003340001	187246		8,0	100,0	12,0	12,5	1	
05003383001	189868			1/8"	28,0	12,0	12,5	1
05003384001	189875			9/64"	28,0	12,0	12,5	1
05003385001	189882			5/32"	28,0	12,0	12,5	1
05003386001	189899			3/16"	28,0	12,0	12,5	1
05003387001	189905			7/32"	28,0	12,0	12,5	1
05003388001	189912			1/4"	28,0	12,0	12,5	1
05003389001	189844			5/16"	28,0	12,0	12,5	1

### 8740 A Zyklop bit socket, 1/4" drive

- Bit socket (non-impact) for manual or machine tool operations
- Hex-Plus allows socket head screws to live longer

### 8740 A Zyklop bit socket, 1/4" drive

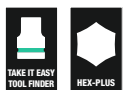

Code	EAN		mm	mm	mm	mm		
05003330001	187154		2,0	28,0	12,0	12,5	1	
05003331001	187161		2,5	28,0	12,0	12,5	1	
05003380001	189820			5/64"	28,0	12,0	12,5	1
05003381001	189837			3/32"	28,0	12,0	12,5	1
05003382001	189851			7/64"	28,0	12,0	12,5	1

### Belt A 2 Zyklop In-Hex-Plus bit socket set with holding function, 1/4" drive

Typically Wera designed robust textile belt with 8 in-hex bit-sockets taking up minimal space.

A smooth Twist to Unlock mechanism ensures a secure fit and simple removal of the sockets.

Comes with Take it easy Tool Finder with colour coding according to size to enable the right tool to be selected easily and quickly. Includes a snap hook for secure fastening to a belt loop or pocket.

Supplied with a nonwoven reverse side and hook and loop strips for simple attachment e.g. to a wall, shelf, tool trolley and to the Wera 2go tool transport system.

- 8-piece bit socket set on a robust textile belt, 1/4"
- Bit-sockets with all the advantages of the Wera bit technology
- Bit sockets with retaining function for hexagon socket screws
- Take it easy tool finder with colour coding according to sizes
- Smooth Twist to Unlock mechanism for a secure fit and simple removal of the sockets
- Suitable for attachment to a wall, shelf, tool trolley and to the Wera 2go System

### Belt A 2 Zyklop In-Hex-Plus bit socket set with holding function, 1/4" drive



Code	EAN		
05003881001	190765		1
		8740 A	1x 2,0x28,0; 1x 2,5x28,0
		8740 A HF	1x 3,0x28,0; 1x 4,0x28,0; 1x 5,0x28,0; 1x 6,0x28,0; 1x 7,0x28,0; 1x 8,0x28,0
		Belt A 0/8	1x 39,0x220,0
		Hook and Loop Fastener Strip 30	1x 30,0x200,0

### 8740 A HF 1 Zyklop bit socket set with holding function, 1/4" drive

- Compact textile box with high robustness, low weight and volume
- Bit socket (non-impact) for manual or power tool operations
- The holding function holds screws securely on the tool
- Take it easy tool finder with colour coding according to sizes
- Knurling on lower socket end for more grip when used manually
- Long design

### 8740 A HF 1 Zyklop bit socket set with holding function, 1/4" drive



Code	EAN			
05003345001	191007			1
		○	8740 A HF 1x 4,0x100,0; 1x 5,0x100,0; 1x 6,0x100,0; 1x 7,0x100,0; 1x 8,0x100,0	
			Hook and Loop Fastener Strip 70 1x 50,0x70,0	

### 8751 A Phillips Zyklop bit socket, 1/4" drive

- Extremely short

### 8751 A Phillips Zyklop bit socket, 1/4" drive



Code	EAN							
05003350001	187253	PH 1	28,0	12,0	11,0	12,5		1
05003351001	187260	PH 2	28,0	12,0	11,0	12,5		1
05003352001	187277	PH 3	28,0	12,0	11,0	12,5		1

### 8755 A Pozidriv Zyklop bit socket, 1/4" drive

- Extremely short

### 8755 A Pozidriv Zyklop bit socket, 1/4" drive



Code	EAN							
05003353001	187284	PZ 1	28,0	12,0	11,0	12,5		1
05003354001	187291	PZ 2	28,0	12,0	11,0	12,5		1
05003355001	187307	PZ 3	28,0	12,0	11,0	12,5		1

### 8700 A FL Slotted screws Zyklop bit socket, 1/4" drive

- Extremely short

### 8700 A FL Slotted screws Zyklop bit socket, 1/4" drive



Code	EAN							
05003320001	187314	0,8	5,5	28,0	12,0	11,0	11,0	1
05003321001	187321	1,0	5,5	28,0	12,0	11,0	11,0	1
05003322001	187338	1,2	6,5	28,0	12,0	11,0	11,0	1

### 8796 LA Zyklop "flexible-lock" extension with free-turning sleeve, long, 1/4"

- For 1/4" square sockets with ball lock
- Flexible lock system for either locking or rapid exchange of the attached tool
- With free-turning sleeve for rapid tightening and loosening of screws and nuts

### 8796 LA Zyklop "flexible-lock" extension with free-turning sleeve, long, 1/4"

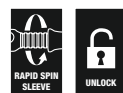

Code	EAN							
05003531001	121059	1/4"	150,0					1

### 8796 SA Zyklop "flexible-lock" extension with free-turning sleeve, short, 1/4"

- For 1/4" square sockets with ball lock
- Flexible lock system for either locking or rapid exchange of the attached tool
- With free-turning sleeve for rapid tightening and loosening of screws and nuts

### 8796 SA Zyklop "flexible-lock" extension with free-turning sleeve, short, 1/4"



Code	EAN	□	⌀						
05003530001	121042	1/4"	75,0						1

### 8794 LA Zyklop extension with free-turning sleeve, long, 1/4"

Wera Zyklop extension with easy-to-grip free-turning sleeve for rapid tightening and loosening of screws and nuts. Out of high quality chrome vanadium steel, matt chrome-plated.

### 8794 LA Zyklop extension with free-turning sleeve, long, 1/4"



Code	EAN	□	⌀						
05003526001	121073	1/4"	150,0						1

### 8794 SA Zyklop extension with free-turning sleeve, short, 1/4"

Wera Zyklop extension with easy-to-grip free-turning sleeve for rapid tightening and loosening of screws and nuts. Out of high quality chrome vanadium steel, matt chrome-plated.

### 8794 SA Zyklop extension with free-turning sleeve, short, 1/4"



Code	EAN	□	⌀						
05003525001	121066	1/4"	75,0						1

### 8789 A Zyklop sliding T-handle, 1/4"

Wera Zyklop T-handle for higher torque transfer. For 1/4" square sockets with ball lock. Adjustable drive, therefore more flexible usage. Out of high quality chrome vanadium steel, matt chrome-plated.

### 8789 A Zyklop sliding T-handle, 1/4"



Code	EAN	□	⌀						
05003524001	121493	1/4"	110,0						3

### 8795 A Zyklop universal joint, 1/4"

Wera Zyklop universal joint for 1/4" square sockets with ball lock.

### 8795 A Zyklop universal joint, 1/4"



Code	EAN	□	⌀						
05003528001	121509	1/4"	35,5						1

### 8784 A1 Zyklop bit adaptor, 1/4"

- 1/4" Zyklop adaptor with quick-release chuck for rapid bit change

#### 8784 A1 Zyklop bit adaptor, 1/4"



Code	EAN								
05003529001	121035	1/4"	1/4"	37,0					1

### 8794 A Zyklop wobble extension, 1/4"

Wobble extension for the Wera Zyklop. Swivel angle of 15° in all directions. This ensures rapid and precise work even in confined working situations.

#### 8794 A Zyklop wobble extension, 1/4"



Code	EAN								
05003527001	121080	1/4"	56,0						1

### Socket rail A (textile belt), 9 location, unloaded



Code	EAN								
05003891001	192424								1
								<b>Belt A 0/9</b> 1x 39,0x238,0	
								<b>Hook and Loop Fastener Strip 30</b> 1x 30,0x200,0	

### Socket rail A (textile belt), 8 location, unloaded



Code	EAN								
05003890001	192417							1	
								<b>Belt A 0/8</b> 1x 39,0x220,0	
								<b>Hook and Loop Fastener Strip 30</b> 1x 30,0x200,0	

### 9600 Magnetic socket rail, 1/4", empty

1 socket rail, empty. For up to 10 sockets and/or bit sockets with 1/4" drive.

The rail allows temporary attachment to metallic surfaces and, with its twist-to-unlock function, ensures secure locking and unlocking of the sockets.

- Rail with secure bit mounting and yet easy removal (twist-to-unlock) for temporary attachment on wall, shelf or workshop trolley
- Smooth Twist to Unlock mechanism for a secure fit and simple removal of the sockets
- Empty, for up to 10 sockets, 1/4"

### 9600 Magnetic socket rail, 1/4", empty

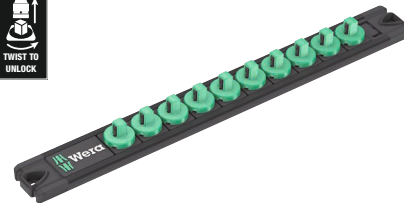
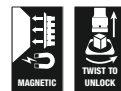

Code	EAN							
05136420001	223326	30,0	270,0					1

## Zyklop Speed - incredibly fast and incredibly flexible

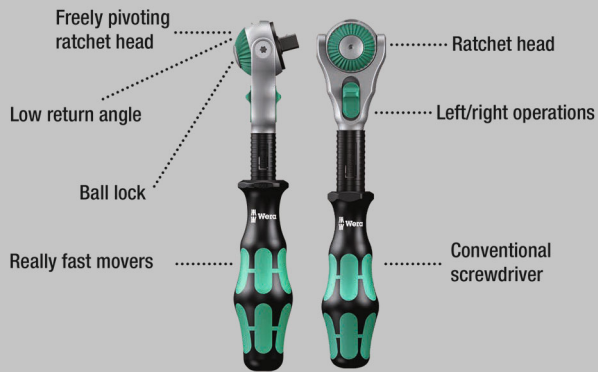

Incredibly compact set arrangement with many tools in a minimum of space. A completely new ratchet set feeling thanks to the unique textile boxes that are very robust and durable.

They can be positioned upright for tidy storage on the workshop shelf. Additional surface protection due to textile outer material. Low weight and volume for simpler mobility.

Take it easy Tool Finder with colour coding according to sizes.

- Freely pivoting ratchet head with 5 predefined locking positions
- Fine toothing with 72 teeth
- Small return angle of only 5°
- Free-turning sleeve for high working speeds
- Take it easy tool finder with colour coding according to sizes
- Compact textile box with high robustness, low weight and volume

## 8100 SB All-in Zyklop Speed ratchet set, 3/8" drive

- Easy removal of the ratchet thanks to Twist-to-unlock system

## 8100 SB All-in Zyklop Speed ratchet set, 3/8" drive



Code	EAN		
05003536001	4013288 225573		1
		8000 B 1x 3/8"x199,0	
		8794 B 1x 3/8"x76,0	
		8796 LB 1x 3/8"x200,0	
		8790 HMB HF 1x 6,0x29,0; 1x 7,0x29,0; 1x 8,0x29,0; 1x 9,0x29,0; 1x 10,0x29,0; 1x 11,0x29,0; 1x 12,0x29,0; 1x 13,0x29,0; 1x 14,0x29,0; 1x 15,0x29,0; 1x 16,0x29,0; 1x 17,0x29,0; 1x 18,0x29,0; 1x 19,0x29,0	
		8767 B HF 1x TX 10x35,0; 1x TX 15x35,0; 1x TX 20x35,0; 1x TX 25x35,0; 1x TX 27x35,0; 1x TX 30x35,0; 1x TX 40x35,0; 1x TX 45x38,5; 1x TX 50x38,5	
		8740 B HF 1x 3,0x35,0; 1x 4,0x35,0; 1x 5,0x35,0; 1x 6,0x35,0; 1x 7,0x38,5; 1x 8,0x38,5; 1x 9,0x38,5; 1x 10,0x38,5	
		Nut Extractor 1x 14,0x43,0	
		Hook and Loop Fastener Strip 240 1x 50,0x240,0	



### 8100 SB 6 Zyklop Speed Ratchet Set, 3/8" drive, metric



### 8100 SB 9 Zyklop Speed Ratchet Set, 3/8" drive, imperial



Code	EAN		
05004046001	4013288 173911		1
		<input type="checkbox"/> <b>8000 B</b> 1x 3/8"x199,0	
		<input checked="" type="checkbox"/> <b>8790 HMB</b> 1x 8,0x29,0; 1x 10,0x29,0; 1x 12,0x29,0; 1x 13,0x29,0; 1x 15,0x29,0; 1x 16,0x30,0; 1x 17,0x30,0; 1x 18,0x30,0; 1x 19,0x30,0	
		<input checked="" type="checkbox"/> <input type="checkbox"/> <b>8794 LB</b> 1x 3/8"x200,0	
		<input checked="" type="checkbox"/> <input type="checkbox"/> <b>8794 B</b> 1x 3/8"x76,0	
		<input checked="" type="checkbox"/> <input type="checkbox"/> <b>8784 B1</b> 1x 1/4"x3/8"x44,0	
		<input checked="" type="checkbox"/> <b>851/4 TZ PH</b> 1x PH 1x50; 1x PH 2x50; 1x PH 3x50	
		<input checked="" type="checkbox"/> <b>855/4 TZ PZ</b> 1x PZ 1x50; 1x PZ 2x50; 1x PZ 3x50	
		<input checked="" type="checkbox"/> <b>867/4 Z TORX®</b> 1x TX 20x50; 1x TX 25x50; 1x TX 27x50; 1x TX 30x50; 1x TX 40x50	
		<input type="checkbox"/> <b>840/4 Z Hex-Plus</b> 1x 4,0x50; 1x 5,0x50; 1x 6,0x50; 1x 8,0x50	
		<input type="checkbox"/> <b>800/4 Z</b> 1x 1,0x5,5x50	

Code	EAN		
05004049001	4013288 173980		1
		<input type="checkbox"/> <b>8000 B</b> 1x 3/8"x199,0	
		<input checked="" type="checkbox"/> <b>8790 HMB</b> 1x 1/4"x29,0; 1x 5/16"x29,0; 1x 3/8"x29,0; 1x 7/16"x29,0; 1x 1/2"x29,0; 1x 9/16"x29,0; 1x 5/8"x30,0; 1x 11/16"x30,0; 1x 3/4"x30,0	
		<input checked="" type="checkbox"/> <input type="checkbox"/> <b>8794 LB</b> 1x 3/8"x200,0	
		<input checked="" type="checkbox"/> <input type="checkbox"/> <b>8794 B</b> 1x 3/8"x76,0	
		<input checked="" type="checkbox"/> <input type="checkbox"/> <b>8784 B1</b> 1x 1/4"x3/8"x44,0	
		<input checked="" type="checkbox"/> <b>851/4 TZ PH</b> 1x PH 1x50; 1x PH 2x50; 1x PH 3x50	
		<input checked="" type="checkbox"/> <b>855/4 TZ PZ</b> 1x PZ 1x50; 1x PZ 2x50; 1x PZ 3x50	
		<input checked="" type="checkbox"/> <b>867/4 Z TORX®</b> 1x TX 20x50; 1x TX 25x50; 1x TX 27x50; 1x TX 30x50; 1x TX 40x50	
		<input type="checkbox"/> <b>840/4 Z Hex-Plus</b> 1x 3/16"x50; 1x 7/32"x50; 1x 1/4"x50; 1x 5/16"x50	
		<input type="checkbox"/> <b>800/4 Z</b> 1x 1,0x5,5x50	

## 8100 SB 2 Zyklop Speed Ratchet Set, 3/8" drive, metric

- 43-piece set in a robust metal case

### 8100 SB 2 Zyklop Speed Ratchet Set, 3/8" drive, metric



Code	EAN		
05003594001	4013288 121141		1
		<input type="checkbox"/> <b>8000 B</b> 1x 3/8"x199,0	
		<input checked="" type="checkbox"/> <b>8790 HMB</b> 1x 6,0x29,0; 1x 7,0x29,0; 1x 8,0x29,0; 1x 9,0x29,0; 1x 10,0x29,0; 1x 11,0x29,0; 1x 12,0x29,0; 1x 13,0x29,0; 1x 14,0x29,0; 1x 15,0x29,0; 1x 16,0x30,0; 1x 17,0x30,0; 1x 18,0x30,0; 1x 19,0x30,0; 1x 20,0x30,0; 1x 21,0x30,0; 1x 22,0x30,0; 1x 24,0x32,0	
		<input type="checkbox"/> <b>8789 B</b> 1x 3/8"x165,0	
		<input checked="" type="checkbox"/> <b>8794 B</b> 1x 3/8"x76,0	
		<input checked="" type="checkbox"/> <b>8795 B</b> 1x 3/8"x50,0	
		<input checked="" type="checkbox"/> <b>8784 B1</b> 1x 1/4"x3/8"x44,0	
		<input checked="" type="checkbox"/> <b>8796 SB</b> 1x 3/8"x125,0	
		<input checked="" type="checkbox"/> <b>8796 LB</b> 1x 3/8"x200,0	
		<input checked="" type="checkbox"/> <b>851/1 Z PH</b> 1x PH 2x25; 1x PH 3x25	
		<input checked="" type="checkbox"/> <b>855/1 Z PZ</b> 1x PZ 2x25; 1x PZ 3x25	
		<input checked="" type="checkbox"/> <b>867/1 Z TORX® BO</b> 1x TX 10x25; 1x TX 15x25; 1x TX 20x25; 1x TX 25x25; 1x TX 27x25; 1x TX 30x25; 1x TX 40x25	
		<input type="checkbox"/> <b>840/1 Z Hex-Plus</b> 1x 3,0x25; 1x 4,0x25; 1x 5,0x25; 1x 6,0x25; 1x 8,0x25; 1x 10,0x25	
		<input checked="" type="checkbox"/> <b>800/1 Z</b> 1x 1,0x5,5x25	

## 8100 SB 4 Zyklop Speed Ratchet Set, 3/8" drive, imperial

- 38-piece set in a robust metal case

### 8100 SB 4 Zyklop Speed Ratchet Set, 3/8" drive, imperial



Code	EAN		
05003596001	4013288 121165		1
		<input type="checkbox"/> <b>8000 B</b> 1x 3/8"x199,0	
		<input checked="" type="checkbox"/> <b>8790 HMB</b> 1x 1/4"x29,0; 1x 5/16"x29,0; 1x 11/32"x29,0; 1x 3/8"x29,0; 1x 7/16"x29,0; 1x 1/2"x29,0; 1x 9/16"x29,0; 1x 5/8"x30,0; 1x 11/16"x30,0; 1x 3/4"x30,0; 1x 13/16"x30,0; 1x 7/8"x30,0	
		<input type="checkbox"/> <b>8789 B</b> 1x 3/8"x165,0	
		<input checked="" type="checkbox"/> <b>8794 B</b> 1x 3/8"x76,0	
		<input checked="" type="checkbox"/> <b>8795 B</b> 1x 3/8"x50,0	
		<input checked="" type="checkbox"/> <b>8784 B1</b> 1x 1/4"x3/8"x44,0	
		<input checked="" type="checkbox"/> <b>8796 SB</b> 1x 3/8"x125,0	
		<input checked="" type="checkbox"/> <b>8796 LB</b> 1x 3/8"x200,0	
		<input checked="" type="checkbox"/> <b>851/1 Z PH</b> 1x PH 2x25; 1x PH 3x25	
		<input checked="" type="checkbox"/> <b>855/1 Z PZ</b> 1x PZ 2x25; 1x PZ 3x25	
		<input checked="" type="checkbox"/> <b>867/1 Z TORX® BO</b> 1x TX 10x25; 1x TX 15x25; 1x TX 20x25; 1x TX 25x25; 1x TX 27x25; 1x TX 30x25; 1x TX 40x25	
		<input checked="" type="checkbox"/> <b>800/1 Z</b> 1x 1,0x5,5x25	
		<input type="checkbox"/> <b>840/1 Z Hex-Plus</b> 1x 5/64"x25; 1x 3/32"x25; 1x 1/8"x25; 1x 9/64"x25; 1x 5/32"x25; 1x 3/16"x25; 1x 7/32"x25	

## Zyklop Speed - incredibly fast and incredibly flexible

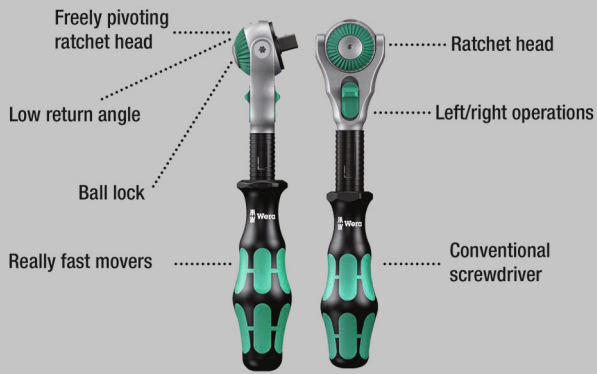

27-piece  $\frac{3}{8}$ " ratchet set for typical bicycle operations with extensive accessories:

1 Zyklop Speed ratchet with  $\frac{3}{8}$ " drive, 10 Zyklop sockets, 2 Zyklop bit sockets with 30mm and extra slim profile area for better accessibility in tight workspaces.

With Take it easy tool finder: Colour coding by size. 1 Zyklop extension (short) with fast-rotating sleeve, 1 Wobble extension, 1 bit adapter, 1 connection part  $\frac{3}{8}$ " external square head to  $\frac{1}{2}$ " external square head, 10 bits, tough, for universal use.

Incredibly compact set arrangement for many tools in a tight space thanks to the highly robust and durable textile box.

Can be placed in an upright position for clearly arranged storage in the workshop shelf. Additional surface protection due to textile outer material. Low weight and small size for better mobility.

- 27-piece  $\frac{3}{8}$ " ratchet set including fine-toothed Zyklop Speed ratchet with swivelling ratchet head, push-button release and right/left switching
- Low return angle of only  $5^\circ$  for working in a small space
- Sockets and bits for the most popular screw profiles for road bikes, mountain bikes and e-bikes
- Assortment in robust textile box with low weight for easy transport
- With adapter from  $\frac{3}{8}$ " square head socket to  $\frac{1}{2}$ " external square head for mounting special bicycle tools

## Bicycle set 7



Code	EAN		
05004175001	4013288 220608		1
		8000 B 1x $\frac{3}{8}$ "x199,0	
		8790 HMB 1x 6,0x29,0; 1x 7,0x29,0; 1x 8,0x29,0; 1x 9,0x29,0; 1x 10,0x29,0; 1x 11,0x29,0; 1x 12,0x29,0; 1x 13,0x29,0; 1x 14,0x29,0	
		8790 HMB Deep 1x 15,0x64,0	
		8740 B 1x 8,0x100,0; 1x 10,0x100,0	
		8794 B 1x $\frac{3}{8}$ "x76,0	
		8784 B1 1x $\frac{1}{4}$ "x $\frac{3}{8}$ "x44,0	
		8794 SB 1x $\frac{3}{8}$ "x125,0	
		781 B 1x 781 B/C, $\frac{1}{2}$ "x36,0x $\frac{3}{8}$ "	
		840/4 Z Hex-Plus 1x 3,0x50; 1x 4,0x50; 1x 5,0x50; 1x 6,0x50	
		867/4 Z TORX® 1x TX 10x50; 1x TX 15x50; 1x TX 20x50; 1x TX 25x50; 1x TX 27x50; 1x TX 30x50	

### 8000 B Zyklop Speed Ratchet with $\frac{3}{8}$ " drive

- Combines five different types of a ratchet in one
- Flywheel design and easy-to-grip free-turning sleeve for very high working speeds
- Freely pivoting ratchet head, push button release and left/right switchover
- Fine-tooth design allows a small return angle of  $5^\circ$
- Can also be used as a screwdriver

### 8000 B Zyklop Speed Ratchet with $\frac{3}{8}$ " drive



Code	EAN					
05003550001	4013288 121875	$\frac{3}{8}$ "	199,0			1

### 8000 B SB Zyklop Speed Ratchet with 3/8" drive



Code		EAN		3
05073261001	128041	4013288	8000 B	
		128041	1x 3/8"x199.0	

### 8100 SB 12 Zyklop Comfort Ratchet set, reversing lever, 3/8" drive, metric

16-piece Zyklop Comfort ratchet set in a light and robust, durable textile box.

The 2-component plastic sleeve of the Zyklop Comfort ratchet makes working comfortable even in the cold and at the same time protects surfaces against damage.

The Zyklop Impaktor sockets stand out with higher-than-average service life even at extreme requirements.

The required size is easily accessible due to the "Take it easy" Tool finder (colour coding by size). The Zyklop extension also makes it easy to operate hard-to-reach screws and bolts.

### 8100 SB 12 Zyklop Comfort Ratchet set, reversing lever, 3/8" drive, metric



Code		EAN		1
05005530001	227980	4013288	8010 B	
			1x 3/8"x230,0	
			<b>8790 B Impaktor</b>	
			1x 8,0x30,0; 1x 10,0x30,0; 1x 11,0x30,0; 1x 12,0x30,0; 1x 13,0x30,0; 1x 14,0x30,0; 1x 15,0x30,0; 1x 16,0x30,0; 1x 17,0x30,0; 1x 18,0x30,0; 1x 19,0x30,0; 1x 21,0x32,0; 1x 22,0x32,0; 1x 24,0x32,0	
			<b>8798 B</b>	
			1x 3/8"x152,4	

### 8100 SB 13 Zyklop Comfort Ratchet set, reversing lever, 3/8" drive, imperial

- 11-piece Zyklop Comfort ratchet set; imperial sizes

### 8100 SB 13 Zyklop Comfort Ratchet set, reversing lever, 3/8" drive, imperial



Code	EAN				
05005531001	227973				1
		<input type="checkbox"/>	<b>8010 B</b> 1x 3/8"x230,0		
		<input checked="" type="checkbox"/>	<b>8790 B Impaktor</b> 1x 1/4"x30,0; 1x 5/16"x30,0; 1x 3/8"x30,0; 1x 7/16"x30,0; 1x 1/2"x30,0; 1x 9/16"x30,0; 1x 5/8"x30,0; 1x 11/16"x30,0; 1x 3/4"x30,0		
		<input checked="" type="checkbox"/>	<b>8798 B</b> 1x 3/8"x152,4		

### 8010 B Zyklop Comfort Ratchet, with reversing lever, with 3/8" drive

Compelling Wera style Zyklop Comfort ratchet with reversing lever. Comfortable 2-component plastic sleeve. Protects sensitive surfaces. Slim design for working even in very confined spaces.

The fine toothing with 80 teeth allows for a low return angle of only 4.5°. With reversing lever to reverse rotation easily. With safe socket locking via push-button.

### 8010 B Zyklop Comfort Ratchet, with reversing lever, with 3/8" drive



Code	EAN							
05005540001	227195	3/8"	230,0					1

## Zyklop Metal with push-through square

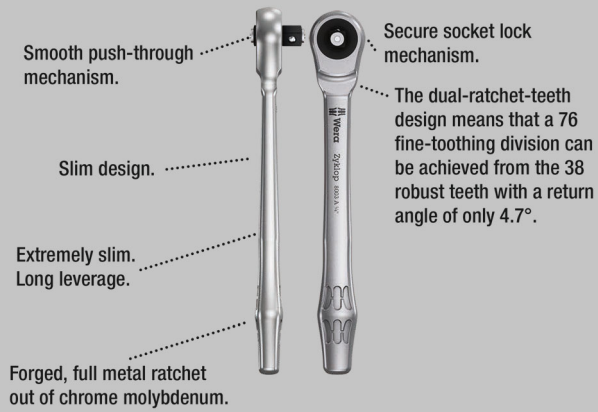

Incredibly compact set arrangement with many tools in a minimum of space. A completely new ratchet set feeling thanks to the unique textile boxes that are very robust and durable.

They can be positioned upright for tidy storage on the workshop shelf. Additional surface protection due to textile outer material. Low weight and volume for simpler mobility. Take it easy Tool Finder with colour coding according to sizes.

- Extremely slim ratchet with long lever
- Return angle of only 4.7°
- Absolutely smooth switchover of the non-detachable push-through square

## 8100 SB 7 Zyklop Metal Ratchet Set with push-through square, 3/8" drive, metric



Code	EAN		
05004047001	4013288 173867		1
		8003 B 1x 3/8"x222,0	
		8790 HMB 1x 8,0x29,0; 1x 10,0x29,0; 1x 12,0x29,0; 1x 13,0x29,0; 1x 15,0x29,0; 1x 16,0x30,0; 1x 17,0x30,0; 1x 18,0x30,0; 1x 19,0x30,0	
		8794 LB 1x 3/8"x200,0	
		8794 B 1x 3/8"x76,0	
		8784 B1 1x 1/4"x3/8"x44,0	
		851/1 Z PH 1x PH 1x25; 1x PH 2x25; 1x PH 3x25	
		855/1 Z PZ 1x PZ 1x25; 1x PZ 2x25	
		867/1 TORX® 1x TX 15x25; 1x TX 20x25; 1x TX 25x25; 1x TX 27x25; 1x TX 30x25; 1x TX 40x25	
		840/1 Z Hex-Plus 1x 3,0x25; 1x 4,0x25; 1x 5,0x25; 1x 6,0x25; 1x 8,0x25	

### 8100 SB 10 Zyklop Metal Ratchet Set with push-through square, 3/8" drive, imperial



Code	EAN			
05004050001	4013288 173935			1
		<b>8003 B</b> 1x 3/8"x222,0		
		<b>8790 HMB</b> 1x 1/4"x29,0; 1x 5/16"x29,0; 1x 3/8"x29,0; 1x 7/16"x29,0; 1x 1/2"x29,0; 1x 9/16"x29,0; 1x 5/8"x30,0; 1x 11/16"x30,0; 1x 3/4"x30,0		
		<b>8794 LB</b> 1x 3/8"x200,0		
		<b>8794 B</b> 1x 3/8"x76,0		
		<b>8784 B1</b> 1x 1/4"x3/8"x44,0		
		<b>851/1 Z PH</b> 1x PH 1x25; 1x PH 2x25; 1x PH 3x25		
		<b>855/1 Z PZ</b> 1x PZ 1x25; 1x PZ 2x25		
		<b>867/1 TORX®</b> 1x TX 15x25; 1x TX 20x25; 1x TX 25x25; 1x TX 27x25; 1x TX 30x25; 1x TX 40x25		
		<b>840/1 Z Hex-Plus</b> 1x 5/32"x25; 1x 3/16"x25; 1x 7/32"x25; 1x 1/4"x25; 1x 5/16"x25		

### 8003 B Zyklop Metal Ratchet with push-through square and 3/8" drive

- Forged, full metal ratchet (chrome-molybdenum); slim design to enable work in very confined spaces.
- The dual-ratchet-teeth design means that a 76 fine-toothing division can be achieved from the 38 robust teeth with a return angle of only 4.7°.
- Absolutely smooth switchover of the non-detachable push-through square
- For 3/8" square sockets with ball lock

### 8003 B Zyklop Metal Ratchet with push-through square and 3/8" drive



Code	EAN							
05004033001	4013288 174031	3/8"	222,0	27	29			3

## Zyklop Metal with switch lever



Incredibly compact set arrangement with many tools in a minimum of space. A completely new ratchet set feeling thanks to the unique textile boxes that are very robust and durable.

They can be positioned upright for tidy storage on the workshop shelf. Additional surface protection due to textile outer material. Low weight and volume for simpler mobility. Take it easy Tool Finder with colour coding according to sizes.

- Convenient direction change thanks to switchover lever
- Extremely slim ratchet with long lever
- Return angle of only 5°
- Compact textile box with high robustness, low weight and volume

## 8100 SB 8 Zyklop Metal Ratchet Set with switch lever, 3/8" drive, metric

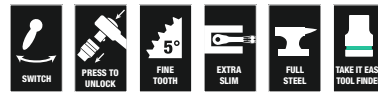

Code	EAN		
05004048001	4013288 173928		1
		<b>8004 B</b> 1x 3/8"x222,0	
		<b>8790 HMB</b> 1x 8,0x29,0; 1x 10,0x29,0; 1x 12,0x29,0; 1x 13,0x29,0; 1x 15,0x29,0; 1x 16,0x30,0; 1x 17,0x30,0; 1x 18,0x30,0; 1x 19,0x30,0	
		<b>8794 LB</b> 1x 3/8"x200,0	
		<b>8794 B</b> 1x 3/8"x76,0	
		<b>8784 B1</b> 1x 1/4"x3/8"x44,0	
		<b>851/1 Z PH</b> 1x PH 1x25; 1x PH 2x25; 1x PH 3x25	
		<b>855/1 Z PZ</b> 1x PZ 1x25; 1x PZ 2x25	
		<b>867/1 TORX®</b> 1x TX 15x25; 1x TX 20x25; 1x TX 25x25; 1x TX 27x25; 1x TX 30x25; 1x TX 40x25	
		<b>840/1 Z Hex-Plus</b> 1x 3,0x25; 1x 4,0x25; 1x 5,0x25; 1x 6,0x25; 1x 8,0x25	



### 8100 SB 11 Zyklop Metal Ratchet Set with switch lever, 3/8" drive, imperial



Code	EAN			
05004051001	173959			1
		8004 B	1x 3/8"x222,0	
		8790 HMB	1x 1/4"x29,0; 1x 5/16"x29,0; 1x 3/8"x29,0; 1x 7/16"x29,0; 1x 1/2"x29,0; 1x 9/16"x29,0; 1x 5/8"x30,0; 1x 11/16"x30,0; 1x 3/4"x30,0	
		8794 LB	1x 3/8"x200,0	
		8794 B	1x 3/8"x76,0	
		8784 B1	1x 1/4"x3/8"x44,0	
		851/1 Z PH	1x PH 1x25; 1x PH 2x25; 1x PH 3x25	
		855/1 Z PZ	1x PZ 1x25; 1x PZ 2x25	
		867/1 TORX®	1x TX 15x25; 1x TX 20x25; 1x TX 25x25; 1x TX 27x25; 1x TX 30x25; 1x TX 40x25	
		840/1 Z Hex-Plus	1x 5/32"x25; 1x 3/16"x25; 1x 7/32"x25; 1x 1/4"x25; 1x 5/16"x25	

### 8100 SB HF 1 Zyklop Metal Ratchet Set with switch lever, 3/8" drive, with holding function, metric

- Colour coding of the sockets according to size

### 8100 SB HF 1 Zyklop Metal Ratchet Set with switch lever, 3/8" drive, with holding function, metric



Code	EAN			
05003785001	195081			1
		8004 B	1x 3/8"x222,0	
		8790 HMB HF	1x 8,0x29,0; 1x 10,0x29,0; 1x 12,0x29,0; 1x 13,0x29,0; 1x 15,0x29,0; 1x 16,0x29,0; 1x 17,0x29,0; 1x 18,0x29,0; 1x 19,0x29,0	
		8794 LB	1x 3/8"x200,0	
		8794 B	1x 3/8"x76,0	
		Nut Extractor	1x 14,0x43,0	
		Hook and Loop Fastener Strip 240	1x 50,0x240,0	

### The Zyklop Metal Ratchets Switch, 3/8"

- Convenient direction change thanks to switchover lever
- Extremely slim ratchet with long lever
- Return angle of only 5°
- Secure socket locking

### 8004 B Zyklop Metal Ratchet with switch lever and 3/8" drive



Code	EAN						
05004034001	174048	3/8"	222,0	26	29		3

### 8790 B Impaktor socket with 3/8" drive

- For use with electric or pneumatic wrenches with 3/8" drive
- Impaktor technology for above-average service life
- Hexagonal profile enables precise and profile-preserving screwdriving with high power transmission
- With Take it easy tool finder: colour coding by size
- With cross-bore and ring socket for securing locking pin and locking ring of machine-operated tools

### 8790 B Impaktor socket with 3/8" drive



Code	EAN	mm	mm	mm	mm	mm	mm	mm
05005500001	227218	8,0	30,0	14,1	19,0	1		
05005501001	227225	10,0	30,0	16,6	19,0	1		
05005502001	227232	11,0	30,0	17,8	19,0	1		
05005503001	227249	12,0	30,0	18,2	19,0	1		
05005504001	227256	13,0	30,0	20,0	22,0	1		
05005505001	227263	14,0	30,0	21,0	22,0	1		
05005506001	227270	15,0	30,0	22,0	22,0	1		
05005507001	227287	16,0	30,0	22,0	24,0	1		
05005508001	227294	17,0	30,0	23,0	25,0	1		
05005509001	227300	18,0	30,0	23,0	26,0	1		
05005510001	227317	19,0	30,0	25,0	27,8	1		
05005511001	227324	21,0	32,0	27,0	30,0	1		
05005512001	227331	22,0	32,0	28,0	32,0	1		
05005513001	227348	24,0	32,0	30,0	34,0	1		
05005514001	227362		1/4"	30,0	11,0	19,0	1	
05005515001	227379		5/16"	30,0	14,1	19,0	1	
05005516001	227386		3/8"	30,0	16,6	19,0	1	
05005517001	227393		7/16"	30,0	17,8	19,0	1	
05005518001	227416		1/2"	30,0	20,0	22,0	1	
05005519001	227423		9/16"	30,0	21,0	22,0	1	
05005520001	227430		5/8"	30,0	22,0	24,0	1	
05005521001	227447		11/16"	30,0	23,0	25,0	1	
05005522001	227454		3/4"	30,0	25,0	28,0	1	
05005523001	227461		13/16"	32,0	27,0	30,0	1	
05005524001	227478		7/8"	32,0	28,0	32,0	1	
05005525001	227485		15/16"	32,0	30,0	34,0	1	
05005526001	227492		1"	32,0	32,0	36,0	1	

### 8790 HMB Zyklop 3/8" socket

- 3/8" Zyklop socket
- For manual and power tool operations (non-impact)
- Knurling at lower end to enable easy gripping when used in manual applications
- Take it easy tool finder with colour coding according to sizes

### 8790 HMB Zyklop 3/8" socket



Code	EAN	mm	mm	mm	mm	mm	mm	mm
05003551001	120311	6,0	29,0	10,5	18,0	1		
05003552001	120328	7,0	29,0	11,0	18,0	1		
05003553001	120335	8,0	29,0	12,2	18,0	1		
05003554001	120342	9,0	29,0	13,5	18,0	1		
05003555001	120359	10,0	29,0	14,5	18,0	1		
05003556001	120366	11,0	29,0	16,0	18,0	1		
05003557001	120373	12,0	29,0	17,0	18,0	1		
05003558001	120380	13,0	29,0	18,5	20,0	1		
05003559001	120397	14,0	29,0	19,5	22,0	1		
05003560001	120403	15,0	29,0	21,0	24,0	1		
05003561001	120410	16,0	30,0	22,0	24,0	1		
05003562001	120427	17,0	30,0	23,5	24,0	1		
05003563001	120434	18,0	30,0	24,5	24,0	1		
05003564001	120441	19,0	30,0	26,0	24,0	1		
05003565001	120458	20,0	30,0	28,0	25,0	1		
05003566001	120465	21,0	30,0	28,0	25,0	1		
05003567001	120472	22,0	30,0	32,0	25,0	1		
05003568001	120489	24,0	32,0	32,0	25,0	1		
05003569001	120496		1/4"	29,0	11,0	18,0	1	
05003570001	120502		5/16"	29,0	12,2	18,0	1	
05003571001	120519		11/32"	29,0	13,5	18,0	1	
05003572001	120526		3/8"	29,0	14,5	18,0	1	
05003573001	120533		7/16"	29,0	16,0	18,0	1	
05003574001	120649		1/2"	29,0	18,5	20,0	1	
05003575001	120557		9/16"	29,0	19,5	22,0	1	
05003576001	120564		5/8"	30,0	22,0	24,0	1	
05003577001	120571		11/16"	30,0	23,0	24,0	1	
05003578001	120588		3/4"	30,0	26,0	24,0	1	
05003579001	120595		13/16"	30,0	28,0	25,0	1	
05003580001	120601		7/8"	30,0	32,0	25,0	1	

## 8790 HMB HF Zyklop socket with 3/8" drive with holding function

- Socket (non-impact) for manual or power tool operations
- The holding function holds screws securely on the tool
- Take it easy tool finder with colour coding according to sizes
- Chrome vanadium steel, matt chrome-plated
- Equipped with ball stop groove, knurling at lower end for better gripping

### 8790 HMB HF Zyklop socket with 3/8" drive with holding function



Code	EAN	mm	mm	mm	mm	mm	mm	
05003740001	193919	6,0	29,0	12,7	17,5	6,5	1	
05003741001	193926	7,0	29,0	13,2	17,5	6,5	1	
05003742001	193933	8,0	29,0	14,2	17,5	6,5	1	
05003743001	193940	9,0	29,0	15,7	17,5	6,5	1	
05003744001	193957	10,0	29,0	17,0	17,5	8,0	1	
05003745001	193964	11,0	29,0	18,2	17,5	9,5	1	
05003746001	193971	12,0	29,0	19,0	17,5	9,5	1	
05003747001	193988	13,0	29,0	20,4	19,5	9,5	1	
05003748001	193995	14,0	29,0	21,5	21,5	12,5	1	
05003749001	194008	15,0	29,0	23,5	23,5	12,5	1	
05003750001	194015	16,0	29,0	24,2	23,5	12,5	1	
05003751001	194022	17,0	29,0	26,0	23,5	12,5	1	
05003752001	194039	18,0	29,0	26,5	23,5	12,5	1	
05003753001	194046	19,0	29,0	28,0	23,5	12,5	1	

## 9607 Magnetic rail B Impaktor 1

Socket rail with 10 Impaktor socket wrenches for use with electric or pneumatic wrenches with 3/8" drive. The Impaktor technology ensures a higher-than-average service life even at extreme requirements.

The hexagon profile used allows a high power transmission while simultaneously being precise and protecting the profile. With "Take it easy" Tool finder with colour coding by size - for quick and easy identification of the required tool.

The rail allows temporary attachment to metallic surfaces and, with its twist-to-unlock function, ensures secure locking and unlocking of the sockets.

- 10-piece socket set on socket rail, 3/8"
- Rail with secure socket mounting and yet easy removal (twist-to-unlock) for temporary attachment on wall, shelf or workshop trolley
- Smooth Twist to Unlock mechanism for a secure fit and simple removal of the sockets
- For use with electric or pneumatic wrenches with 3/8" drive
- Impaktor technology for above-average service life
- Hexagonal profile enables precise and profile-preserving screwdriving with high power transmission
- With cross-bore and ring socket for securing locking pin and locking ring of machine-operated tools
- With Take it easy tool finder: colour coding by size

### 9607 Magnetic rail B Impaktor 1



Code	EAN		
05005451001	227546		1
		<b>8790 B Impaktor</b> 1x 10,0x30,0; 1x 13,0x30,0; 1x 15,0x30,0; 1x 16,0x30,0; 1x 17,0x30,0; 1x 18,0x30,0; 1x 19,0x30,0; 1x 21,0x32,0; 1x 22,0x32,0; 1x 24,0x32,0	
		<b>9603</b> 1x 30,0x340,0	

## 9608 Magnetic rail B Impaktor Imperial 1

- Imperial

### 9608 Magnetic rail B Impaktor Imperial 1



Code		EAN		
05005452001		4013288 227553		1
		●	<b>8790 B Impaktor</b> 1x 1/4"x30,0; 1x 3/16"x30,0; 1x 3/8"x30,0; 1x 7/16"x30,0; 1x 1/2"x30,0; 1x 9/16"x30,0; 1x 5/8"x30,0; 1x 11/16"x30,0; 1x 3/4"x30,0	
			<b>9601</b> 1x 30,0x340,0	

## Belt B 1 Zyklop socket set with holding function, 3/8" drive

Typically Wera designed robust textile belt with 9 sockets taking up minimal space. A smooth Twist to Unlock mechanism ensures a secure fit and simple removal of the sockets. Comes with Take it easy Tool Finder with colour coding according to size to enable the right tool to be selected easily and quickly. Includes a snap hook for secure fastening to a belt loop or pocket.

Sockets with holding function for particularly convenient screw-driving with reduced risk of losing the screw when approaching the workpiece. Supplied with a non-woven reverse side and hook and loop strips for simple attachment e.g. to a wall, shelf, tool trolley and to the Wera 2go tool transport system.

- 10-piece socket set on a robust textile belt, 1/4"
- Sockets with holding function for screws/bolts/nuts
- Smooth Twist to Unlock mechanism for a secure fit and simple removal of the sockets
- Take it easy tool finder with colour coding according to sizes
- Suitable for attachment to a wall, shelf, tool trolley and to the Wera 2go System

### Belt B 1 Zyklop socket set with holding function, 3/8" drive



Code		EAN		
05003970001		4013288 194947		1
		●	<b>8790 HMB HF</b> 1x 8,0x29,0; 1x 10,0x29,0; 1x 12,0x29,0; 1x 13,0x29,0; 1x 15,0x29,0; 1x 16,0x29,0; 1x 17,0x29,0; 1x 18,0x29,0; 1x 19,0x29,0	
			<b>Nut Extractor</b> 1x 14,0x43,0	
			<b>Belt B 0/9</b> 1x 45,0x310,0	
			<b>Hook and Loop Fastener Strip 30</b> 1x 30,0x200,0	

### Belt B 4 Zyklop socket set, 3/8" drive

- 9-piece socket set on a robust textile belt, 3/8"
- For manual and power tool operations (non-impact)
- Smooth Twist to Unlock mechanism for a secure fit and simple removal of the sockets
- Take it easy tool finder with colour coding according to sizes
- Suitable for attachment to a wall, shelf, tool trolley and to the Wera 2go System

### Belt B 4 Zyklop socket set, 3/8" drive



Code		EAN		
		4013288		
05003973001	194978			1
		●	<b>8790 HMB</b> 1x 8,0x29,0; 1x 10,0x29,0; 1x 12,0x29,0; 1x 13,0x29,0; 1x 15,0x29,0; 1x 16,0x30,0; 1x 17,0x30,0; 1x 18,0x30,0; 1x 19,0x30,0	
			<b>Belt B 0/9</b> 1x 45,0x310,0	
			<b>Hook and Loop Fastener Strip 30</b> 1x 30,0x200,0	

### Magnetic socket rail B 4 Zyklop socket set, 3/8" drive

Socket rail with 9 manual and machine sockets (non-impact), 3/8". A smooth rotary mechanism allows a secure hold and easy access of the sockets.

With Take it easy tool finder with colour coding by size - to help you find the required tool quickly and easily.

The rail allows temporary attachment to metallic surfaces and, with its twist-to-unlock function, ensures secure locking and unlocking of the sockets.

- 9-piece socket set on socket rail, 3/8"
- Rail with secure bit mounting and yet easy removal (twist-to-unlock) for temporary attachment on wall, shelf or workshop trolley
- Smooth Twist to Unlock mechanism for a secure fit and simple removal of the sockets
- With Take it easy tool finder: colour coding by size

### Magnetic socket rail B 4 Zyklop socket set, 3/8" drive



Code		EAN		
		4013288		
05005430001	223234			1
		●	<b>8790 HMB</b> 1x 8,0x29,0; 1x 10,0x29,0; 1x 12,0x29,0; 1x 13,0x29,0; 1x 15,0x29,0; 1x 16,0x30,0; 1x 17,0x30,0; 1x 18,0x30,0; 1x 19,0x30,0	
			<b>9601</b> 1x 30,0x340,0	

### Magnetic socket rail B Imperial 1 Zyklop socket set 3/8" drive, imperial

Socket rail with 9 manual and machine sockets (non-impact), 3/8". A smooth rotary mechanism allows a secure hold and easy access of the sockets.

With Take it easy tool finder with colour coding by size - to help you find the required tool quickly and easily. The rail allows temporary attachment to metallic surfaces and, with its twist-to-unlock function, ensures secure locking and unlocking of the sockets.

- 9-piece socket set on socket rail, 3/8"
- Rail with secure bit mounting and yet easy removal (twist-to-unlock) for temporary attachment on wall, shelf or workshop trolley
- Smooth Twist to Unlock mechanism for a secure fit and simple removal of the sockets
- With Take it easy tool finder: colour coding by size

### Magnetic socket rail B Imperial 1 Zyklop socket set 3/8" drive, imperial



Code	EAN		
05005450001	223258		1
		<b>8790 HMB</b> 1x 1/4"x29,0; 1x 5/16"x29,0; 1x 11/32"x29,0; 1x 3/8"x29,0; 1x 7/16"x29,0; 1x 1/2"x29,0; 1x 9/16"x29,0; 1x 5/8"x30,0; 1x 3/4"x30,0	
		<b>9601</b> 1x 30,0x340,0	

### 8790 HMB Deep 3/8" socket

Long 3/8" hand and machine socket (ISO 2725 part 3) with ball intercept ring; for external hexagonal bolts and sockets. For use in manual and machine operation (non-impact), even with low-lying screwdriving and protruding threaded rods.

With Take it easy tool finder with colour coding by size - for easy and fast location of the required tool. Easy to grasp even with oily hands. The hexagon profile allows the transmission of high forces and puts less strain on the edges of bolts or screw heads than a double hexagon profile.

Fine-toothed ratchets also make the use of a double hexagon profile superfluous, even in confined spaces, thanks to their small back-pivoting angle.

- Long sockets for low-lying screwdriving, often even with protruding threaded rods in small spaces
- Hexagonal profile enables precise bolting with high power transmission and preserves the profile
- Take it easy tool finder with colour coding according to sizes
- Knurling at lower end to enable easy gripping when used in manual applications
- For manual and machine operation (non-impact), ball intercept ring
- Made of matt chromed chrome-vanadium

### 8790 HMB Deep 3/8" socket



Code	EAN		mm	mm	mm	mm	
05004530001	210388		8,0	64,0	12,2	17,0	1
05004531001	210395		9,0	64,0	13,5	17,0	1
05004532001	210401		10,0	64,0	14,5	17,0	1
05004533001	210418		11,0	64,0	15,7	17,0	1
05004534001	210425		12,0	64,0	16,5	18,0	1
05004535001	210432		13,0	64,0	19,0	17,0	1
05004536001	210449		14,0	64,0	20,0	18,0	1
05004537001	210456		15,0	64,0	22,0	20,0	1
05004538001	210463		16,0	64,0	22,0	20,0	1
05004539001	210470		17,0	64,0	24,0	22,0	1
05004540001	210487		18,0	64,0	26,0	23,0	1
05004541001	210494		19,0	64,0	26,0	23,0	1
05004542001	210500		20,0	64,0	28,0	25,0	1
05004543001	210517		21,0	64,0	28,0	25,0	1
05004544001	210524		22,0	64,0	30,0	26,0	1

### Belt B Deep 1 socket set, 3/8" drive

Robust textile belt in the typical Wera design with 9 long 3/8" manual and machine socket inserts (non-impacting) in a confined space. A smoother turning mechanism ensures a secure holding and easy removal of sockets. Includes snap hook for attaching to belt loops or bags. With fleece backing and hook and loop fastener strips for easy attachment e.g. on wall, shelf, workshop trolley or the Wera 2go tool transport system.

Long 3/8" manual and mechanical socket wrench inserts (ISO 2725 part 3) from Wera for use in manual and machine operation (non-impacting) even with low-lying screwdriving and protruding threaded rods.

With Take it easy tool finder with colour coding by size - for easy and fast location of the required tool. Easy to grasp even with oily hands. With hexagonal profile and ball-catching groove. The hexagon profile allows the transmission of high forces and puts less strain on the edges of bolts or screw heads than a double hexagon profile.

Fine-toothed ratchets also make the use of a double hexagon profile superfluous, even in confined spaces, thanks to their small back-pivoting angle. For external hexagonal bolts and sockets.

- 9-piece socket set on robust textile belt 3/8"
- Smooth Twist to Unlock mechanism for a secure fit and simple removal of the sockets
- Long 3/8" socket for low-profile-fitting screw connections in tight construction spaces and for protruding threaded rods
- Hexagonal profile enables precise and profile-preserving screwdriving with high power transmission
- Take it easy tool finder with colour coding according to sizes

### Magnetic socket rail B Deep 1 socket set, 3/8" drive

Socket rail with 9 long manual and machine sockets (non-impacting), 3/8". A smooth rotary mechanism allows a secure hold and easy access of the sockets.

Long 3/8" manual and machine sockets (ISO 2725 part 3) by Wera for manual and (non-impact) machine use even at low lying couplings and protruding thread rods.

With Take it easy tool finder with colour coding by size - to help you find the required tool quickly and easily.

Slip-proof for easy grip even with oily hands. With hexagon profile and ball stop groove. The hexagon profile enables the transmission of high forces and loads the edges of the bolt or the screw head less than a double hexagon profile.

Fine-teethed ratchets also make use of a double hexagon profile superfluous, even in confined spaces, thanks to their small return angle. For external hexagonal bolts and screws.

The rail allows temporary attachment to metallic surfaces and, with its twist-to-unlock function, ensures secure locking and unlocking of the sockets.

- 9-piece socket set on socket rail, 3/8"
- Rail with secure bit mounting and yet easy removal (twist-to-unlock) for temporary attachment on wall, shelf or workshop trolley
- Smooth Twist to Unlock mechanism for a secure fit and simple removal of the sockets
- Long 3/8" socket for low-profile-fitting screw connections in tight construction spaces and for protruding threaded rods
- Hexagonal profile enables precise and profile-preserving screwdriving with high power transmission

### Belt B Deep 1 socket set, 3/8" drive



Code	EAN		
05004545001	210555		1
		● 8790 HMB Deep 1x 8,0x64,0; 1x 10,0x64,0; 1x 12,0x64,0; 1x 13,0x64,0; 1x 15,0x64,0; 1x 16,0x64,0; 1x 17,0x64,0; 1x 18,0x64,0; 1x 19,0x64,0	
		Belt B 0/9 1x 45,0x310,0	
		Hook and Loop Fastener Strip 30 1x 30,0x200,0	

### Magnetic socket rail B Deep 1 socket set, 3/8" drive



Code	EAN		
05005440001	223241		1
		● 8790 HMB Deep 1x 8,0x64,0; 1x 10,0x64,0; 1x 12,0x64,0; 1x 13,0x64,0; 1x 15,0x64,0; 1x 16,0x64,0; 1x 17,0x64,0; 1x 18,0x64,0; 1x 19,0x64,0	
		9601 1x 30,0x340,0	

### 8767 B HF TORX® Zyklop bit socket with holding function, 3/8" drive

- Bit socket (non-impact) for manual or machine tool operations
- The holding function holds screws securely on the tool
- Take it easy tool finder with colour coding according to sizes
- Knurling on lower end for more grip when used manually
- Chrome vanadium steel, matt chrome-plated

### 8767 B HF TORX® Zyklop bit socket with holding function, 3/8" drive



Code	EAN						
Code	4013288			mm	mm	mm	
05003059001	189097		TX 10	35,0	12,0	17,5	1
05003060001	188830		TX 15	35,0	12,0	17,5	1
05003061001	188847		TX 20	35,0	12,0	17,5	1
05003062001	188854		TX 25	35,0	12,0	17,5	1
05003063001	188861		TX 25	107,0	12,0	17,5	1
05003064001	188878		TX 27	35,0	12,0	17,5	1
05003065001	188885		TX 27	107,0	12,0	17,5	1
05003066001	188892		TX 30	35,0	12,0	17,5	1
05003067001	188908		TX 30	107,0	12,0	17,5	1
05003068001	188915		TX 40	35,0	12,0	17,5	1
05003069001	188922		TX 40	107,0	12,0	17,5	1
05003070001	188939		TX 45	38,5	12,0	17,5	1
05003071001	188946		TX 45	100,0	12,0	17,5	1
05003072001	188953		TX 50	38,5	12,0	17,5	1
05003073001	188960		TX 50	100,0	12,0	17,5	1

### 8767 B TORX® Zyklop Bit socket with 3/8" drive, with extra slim profile area

- Bit socket (non-impact) for manual or machine tool operations
- The holding function holds screws securely on the tool
- With Take it easy tool finder: colour coding by size
- Knurling on lower end for more grip when used manually.
- Chrome vanadium steel, matt chrome-plated

### 8767 B TORX® Zyklop Bit socket with 3/8" drive, with extra slim profile area



Code	EAN						
Code	4013288			mm	mm	mm	
05003074001	227102		TX 25	107,0	12,0	17,5	1
05003075001	227119		TX 30	107,0	12,0	17,5	1



### Belt B 3 TORX® HF Zyklop bit socket set with holding function, 3/8" drive

Typically Wera designed robust textile belt with 9 sockets taking up minimal space. A smooth Twist to Unlock mechanism ensures a secure fit and simple removal of the sockets.

Comes with Take it easy Tool Finder with colour coding according to size to enable the right tool to be selected easily and quickly. Includes a snap hook for secure fastening to a belt loop or pocket. Especially short, stable bit-sockets with all the advantages of the Wera bit technology.

Bit sockets with holding function for particularly convenient screwdriving with reduced risk of losing the screw when approaching the workpiece. Supplied with a nonwoven reverse side and hook and loop strips for simple attachment e.g. to a wall, shelf, tool trolley and to the Wera 2go tool transport system.

- 9-piece bit-socket set on a robust textile belt, 3/8"
- Bit-sockets with all the advantages of the Wera bit technology
- Bit-sockets with holding function for screws/bolts
- Smooth Twist to Unlock mechanism for a secure fit and simple removal of the sockets
- Suitable for attachment to a wall, shelf, tool trolley and to the Wera 2go System

### Belt B 3 TORX® HF Zyklop bit socket set with holding function, 3/8" drive

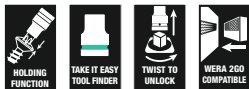

Code	EAN		
05003972001	4013288 194961		1
		<b>8767 B HF</b> 1x TX 10x35,0; 1x TX 15x35,0; 1x TX 20x35,0; 1x TX 25x35,0; 1x TX 27x35,0; 1x TX 30x35,0; 1x TX 40x35,0; 1x TX 45x38,5; 1x TX 50x38,5	
		<b>Belt B 0/9</b> 1x 45,0x310,0	
		<b>Hook and Loop Fastener Strip 30</b> 1x 30,0x200,0	

### 8767 B TORX® HF 1 Zyklop bit socket set with holding function, 3/8" drive

- Bit sockets with holding function for TORX® screws
- The holding function holds screws securely on the tool
- Take it easy tool finder with colour coding according to sizes
- Knurling on lower socket end for more grip when used manually

### 8767 B TORX® HF 1 Zyklop bit socket set with holding function, 3/8" drive

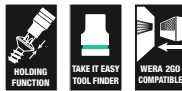

Code	EAN		
05003185001	4013288 195074		1
		<b>8767 B HF</b> 1x TX 25x107,0; 1x TX 27x107,0; 1x TX 30x107,0; 1x TX 40x107,0; 1x TX 45x100,0; 1x TX 50x100,0	
		<b>Hook and Loop Fastener Strip 120</b> 1x 50,0x120,0	

### 8740 B HF Zyklop bit socket with holding function, 3/8" drive

- Bit socket (non-impact) for manual or machine tool operations
- The holding function holds screws securely on the tool
- Take it easy tool finder with colour coding according to sizes

### 8740 B HF Zyklop bit socket with holding function, 3/8" drive



Code	EAN	mm	mm	mm	mm	mm	mm
05003030001	188557	3,0	35,0	12,0	17,5	1	
05003031001	188564	4,0	35,0	12,0	17,5	1	
05003032001	188571	4,0	107,0	12,0	17,5	1	
05003033001	188649	5,0	35,0	12,0	17,5	1	
05003034001	188656	5,0	107,0	12,0	17,5	1	
05003035001	188663	6,0	35,0	12,0	17,5	1	
05003036001	188731	6,0	107,0	12,0	17,5	1	
05003037001	188748	7,0	38,5	12,0	17,5	1	
05003038001	188755	7,0	100,0	12,0	17,5	1	
05003039001	188779	8,0	38,5	12,0	17,5	1	
05003040001	188786	8,0	100,0	12,0	17,5	1	
05003041001	188793	9,0	38,5	12,0	17,5	1	
05003042001	188809	9,0	100,0	12,0	17,5	1	
05003043001	188816	10,0	38,5	12,0	17,5	1	
05003044001	188823	10,0	100,0	12,0	17,5	1	
05003080001	193407	1/8"	35,0	12,0	17,5	1	
05003081001	193414	1/8"	107,0	12,0	17,5	1	
05003082001	193421	9/64"	35,0	12,0	17,5	1	
05003083001	193438	5/32"	35,0	12,0	17,5	1	
05003084001	193445	5/32"	107,0	12,0	17,5	1	
05003085001	193452	3/16"	35,0	12,0	17,5	1	
05003086001	193551	3/16"	107,0	12,0	17,5	1	
05003087001	193568	7/32"	35,0	12,0	17,5	1	
05003088001	193575	7/32"	107,0	12,0	17,5	1	
05003089001	193612	1/4"	35,0	12,0	17,5	1	
05003090001	193629	1/4"	107,0	12,0	17,5	1	
05003091001	193636	5/16"	38,5	12,0	17,5	1	
05003092001	193643	5/16"	100,0	12,0	17,5	1	
05003093001	193650	3/8"	38,5	12,0	17,5	1	
05003094001	193667	3/8"	100,0	12,0	17,5	1	

### 8740 B Zyklop Bit socket with 3/8" drive, with extra slim profile area

- Bit socket (non-impact) for manual or machine tool operations
- The holding function holds screws securely on the tool
- With Take it easy tool finder: colour coding by size

### 8740 B Zyklop Bit socket with 3/8" drive, with extra slim profile area

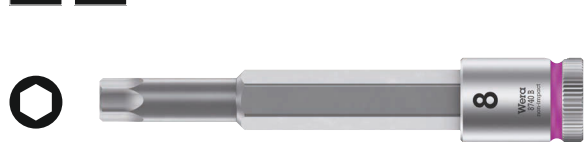

Code	EAN	mm	mm	mm	mm	mm	mm
05003050001	227058	4,0	107,0	12,0	17,5	81,5	1
05003051001	227065	5,0	107,0	12,0	17,5	81,5	1
05003052001	227072	6,0	107,0	12,0	17,5	81,5	1
05003054001	227089	8,0	100,0	12,0	17,5	74,5	1
05003056001	227096	10,0	100,0	12,0	17,5	74,5	1

### Belt B 2 Zyklop In-Hex-Plus bit socket set with holding function, 3/8" drive

Typically Wera designed robust textile belt with 8 in-hex bit-sockets taking up minimal space. A smooth Twist to Unlock mechanism ensures a secure fit and simple removal of the sockets.

Comes with Take it easy Tool Finder with colour coding according to size to enable the right tool to be selected easily and quickly.

Includes a snap hook for secure fastening to a belt loop or pocket. Supplied with a nonwoven reverse side and hook and loop strips for simple attachment e.g. to a wall, shelf, tool trolley and to the Wera 2go tool transport system.

- 8-piece bit socket set on a robust textile belt, 3/8"
- Bit-sockets with all the advantages of the Wera bit technology
- Bit-sockets with holding function for screws/bolts
- Smooth Twist to Unlock mechanism for a secure fit and simple removal of the sockets
- Suitable for attachment to a wall, shelf, tool trolley and to the Wera 2go System

### Belt B 2 Zyklop In-Hex-Plus bit socket set with holding function, 3/8" drive



Code	EAN		
05003971001	4013288 194954		1
		<b>8740 B HF</b> 1x 3,0x35,0; 1x 4,0x35,0; 1x 5,0x35,0; 1x 6,0x35,0; 1x 7,0x38,5; 1x 8,0x38,5; 1x 9,0x38,5; 1x 10,0x38,5	
		<b>Belt B 0/8</b> 1x 45,0x275,0	
		<b>Hook and Loop Fastener Strip 30</b> 1x 30,0x200,0	

### 8740 B HF 1 Zyklop bit socket set with holding function, 3/8" drive

- Compact textile box with high robustness, low weight and volume
- Bit socket (non-impact) for manual or power tool operations
- The holding function holds screws securely on the tool
- Take it easy tool finder with colour coding according to sizes
- Knurling on lower socket end for more grip when used manually
- Long design

### 8740 B HF 1 Zyklop bit socket set with holding function, 3/8" drive



Code	EAN		
05003180001	4013288 195050		1
		<b>8740 B HF</b> 1x 4,0x107,0; 1x 5,0x107,0; 1x 6,0x107,0; 1x 7,0x100,0; 1x 8,0x100,0; 1x 9,0x100,0; 1x 10,0x100,0	
		<b>Hook and Loop Fastener Strip 120</b> 1x 50,0x120,0	

### 8740 B HF Imperial 1 Zyklop bit socket set with holding function, 3/8" drive

- Long version
- Imperial

### 8740 B HF Imperial 1 Zyklop bit socket set with holding function, 3/8" drive



<b>Code</b>	<b>EAN</b>			
05003181001	195067			1
			<b>8740 B HF</b> 1x 1/8"x107,0; 1x 5/32"x107,0; 1x 3/16"x107,0; 1x 7/32"x107,0; 1x 1/4"x107,0; 1x 5/16"x100,0; 1x 3/8"x100,0	
			<b>Hook and Loop Fastener Strip 120</b> 1x 50,0x120,0	

### Belt B Imperial 1 Zyklop In-Hex-Plus bit socket set with holding function, 3/8" drive

Typically Wera designed robust textile belt with 8 in-hex bit-sockets taking up minimal space. A smooth Twist to Unlock mechanism ensures a secure fit and simple removal of the sockets.

Comes with Take it easy Tool Finder with colour coding according to size to enable the right tool to be selected easily and quickly.

Includes a snap hook for secure fastening to a belt loop or pocket. Supplied with a nonwoven reverse side and hook and loop strips for simple attachment e.g. to a wall, shelf, tool trolley and to the Wera 2go tool transport system.

- 8-piece bit socket set on a robust textile belt, 3/8"
- Bit-sockets with all the advantages of the Wera bit technology
- Bit-sockets with holding function for screws/bolts
- Smooth Twist to Unlock mechanism for a secure fit and simple removal of the sockets
- Suitable for attachment to a wall, shelf, tool trolley and to the Wera 2go System
- Imperial

### Belt B Imperial 1 Zyklop In-Hex-Plus bit socket set with holding function, 3/8" drive



<b>Code</b>	<b>EAN</b>			
05003974001	194985			1
			<b>8740 B HF</b> 1x 1/8"x35,0; 1x 9/64"x35,0; 1x 5/32"x35,0; 1x 3/16"x35,0; 1x 7/32"x35,0; 1x 1/4"x35,0; 1x 5/16"x38,5; 1x 3/8"x38,5	
			<b>Belt B 0/8</b> 1x 45,0x275,0	
			<b>Hook and Loop Fastener Strip 30</b> 1x 30,0x200,0	

### Bicycle set 8

7-piece bit socket set with 3/8" drive for typical bicycle operations. Bit sockets with 30mm long and extra slim profile area for better accessibility in tight workspaces. The knurling facilitates manual screwdriving without slipping.

With Take it easy tool finder with colour coding by size - to help you find the required tool quickly and easily.

- Bit sockets with holding function for the most common TORX® and Hex screws
- The holding function holds screws securely on the tool
- With Take it easy tool finder: colour coding by size
- Knurling on lower socket end for more grip when used manually
- In a robust folding bag for easy transport

### Bicycle set 8



Code		EAN							
05004176001		4013288 220622							1
		♻️	<b>8767 B</b>						
			1x TX 25x107,0; 1x TX 30x107,0						
		⊙	<b>8740 B</b>						
			1x 4,0x107,0; 1x 5,0x107,0; 1x 6,0x107,0; 1x 8,0x100,0; 1x 10,0x100,0						
			<b>Hook and Loop Fastener Strip 120</b>						
			1x 50,0x70,0						

### 8796 LB Zyklop „flexible-lock“ extension with free-turning sleeve, long, 3/8"

- For 3/8" square sockets with ball lock
- Flexible lock system for either locking or rapid exchange of the attached tool
- With free-turning sleeve for rapid tightening and loosening of screws and nuts

### 8796 LB Zyklop „flexible-lock“ extension with free-turning sleeve, long, 3/8"



Code		EAN							
05003592001		4013288 121325		3/8"	200,0				1

### 8796 SB Zyklop „flexible-lock“ extension with free-turning sleeve, short, 3/8"

- Flexible lock system for either locking or rapid exchange of the attached tool
- For 3/8" square sockets with ball lock
- With free-turning sleeve for rapid tightening and loosening of screws and nuts

### 8796 SB Zyklop „flexible-lock“ extension with free-turning sleeve, short, 3/8"



Code		EAN							
05003591001		4013288 121318		3/8"	125,0				1

### 8794 LB Zyklop extension with free-turning sleeve, long, 3/8"

Wera Zyklop extension with easy-to-grip free-turning sleeve for rapid tightening and loosening of screws and nuts. Out of high quality chrome vanadium steel, matt chrome-plated.

#### 8794 LB Zyklop extension with free-turning sleeve, long, 3/8"



Code	EAN	□	↑						
05003583001	121288	3/8"	200,0						1

### 8794 SB Zyklop extension with free-turning sleeve, short, 3/8"

Wera Zyklop extension with easy-to-grip free-turning sleeve for rapid tightening and loosening of screws and nuts. Out of high quality chrome vanadium steel, matt chrome-plated.

#### 8794 SB Zyklop extension with free-turning sleeve, short, 3/8"



Code	EAN	□	↑						
05003582001	121271	3/8"	125,0						1

### 8789 B Zyklop sliding T-handle, 3/8"

Wera Zyklop T-handle for higher torque transfer. For 3/8" square sockets with ball lock. Adjustable drive for more flexible usage. Out of high quality chrome vanadium steel, matt chrome-plated.

#### 8789 B Zyklop sliding T-handle, 3/8"



Code	EAN	□	↑						
05003581001	121516	3/8"	165,0						3

### 8795 B Zyklop universal joint, 3/8"

Wera Zyklop universal joint for 3/8" square sockets with ball lock.

#### 8795 B Zyklop universal joint, 3/8"



Code	EAN	□	↑						
05003585001	121523	3/8"	50,0						1

### 8794 B Zyklop wobble extension, 3/8"

Wobble extension for the Wera Zyklop. Swivel angle of 15° in all directions. This ensures rapid and precise work even in confined working situations.

#### 8794 B Zyklop wobble extension, 3/8"



Code	EAN	□	↑						
05003584001	121295	3/8"	76,0						1

### 8784 B1 Zyklop bit adaptor, 3/8"

- 3/8" Zyklop adaptor with quick-release chuck for rapid bit change

#### 8784 B1 Zyklop bit adaptor, 3/8"



Code	EAN	□	□	↑					
05003590001	121301	1/4"	3/8"	44,0					1

### Socket rail B (textile belt), 8 location, unloaded



Code	EAN		
05003980001	4013288 195005		1
		<b>Belt B 0/8</b> 1x 45,0x275,0	
		<b>Hook and Loop Fastener Strip 30</b> 1x 30,0x200,0	

### Socket rail B (textile belt), 9 location, unloaded



Code	EAN		
05003981001	4013288 195012		1
		<b>Belt B 0/9</b> 1x 45,0x310,0	
		<b>Hook and Loop Fastener Strip 30</b> 1x 30,0x200,0	

### 9601 Magnetic socket rail, 3/8", empty

1 socket rail, empty. For up to 10 sockets and/or bit sockets with 3/8" drive.

The rail allows temporary attachment to metallic surfaces and, with its twist-to-unlock function, ensures secure locking and unlocking of the sockets.

- Rail with secure bit mounting and yet easy removal (twist-to-unlock) for temporary attachment on wall, shelf or workshop trolley
- Smooth Twist to Unlock mechanism for a secure fit and simple removal of the sockets
- Empty, for up to 10 sockets, 3/8"



### 9601 Magnetic socket rail, 3/8", empty

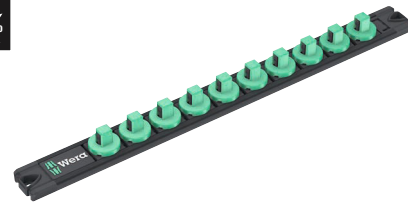

Code	EAN	mm	mm				
05136421001	4013288 223333	30,0	340,0				1

## Zyklop Speed - incredibly fast and incredibly flexible

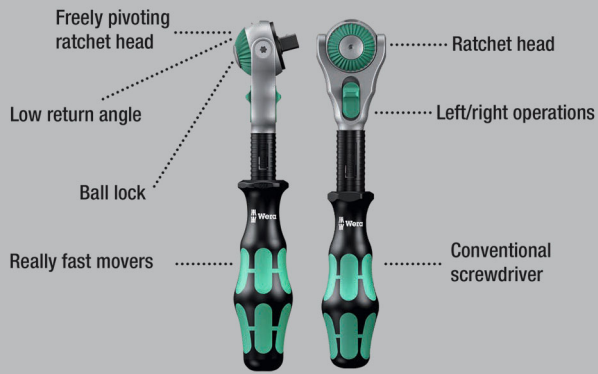

Incredibly compact set arrangement with many tools in a minimum of space. A completely new ratchet set feeling thanks to the unique textile boxes that are very robust and durable.

They can be positioned upright for tidy storage on the workshop shelf. Additional surface protection due to textile outer material. Low weight and volume for simpler mobility. Take it easy Tool Finder with colour coding according to sizes.

- Freely pivoting ratchet head with 5 predefined locking positions
- Fine tothing with 72 teeth
- Small return angle of only 5°
- Free-turning sleeve for high working speeds
- Take it easy tool finder with colour coding according to sizes
- Compact textile box with high robustness, low weight and volume

## 8100 SC 6 Zyklop Speed Ratchet Set, 1/2" drive, metric



Code	EAN		
05004076001	4013288 173874		1
		<b>8000 C</b> 1x 1/2"x277,0	
		<b>8790 HMC</b> 1x 10,0x37,0; 1x 11,0x37,0; 1x 12,0x37,0; 1x 13,0x37,0; 1x 14,0x37,0; 1x 15,0x37,0; 1x 16,0x37,0; 1x 17,0x37,0; 1x 18,0x37,0; 1x 19,0x37,0	
		<b>8794 LC</b> 1x 1/2"x250,0	
		<b>8794 C</b> 1x 1/2"x52,0	
		<b>8784 C2</b> 1x 9/16"x1/2"x50,0	
		<b>851/2 Z PH</b> 1x PH 2x32; 1x PH 3x32	
		<b>855/2 Z PZ</b> 1x PZ 2x32; 1x PZ 3x32	
		<b>867/2 Z TORX®</b> 1x TX 20x35; 1x TX 25x35; 1x TX 30x35; 1x TX 40x35; 1x TX 45x35; 1x TX 50x35	
		<b>840/2 Z</b> 1x 5x30; 1x 6x30; 1x 8x30; 1x 10x30	



## 8100 SC 9 Zyklop Speed Ratchet Set, 1/2" drive, imperial



Code	EAN			
05004079001	4013288 173997			1
		8000 C	1x 1/2"x277,0	
		8790 HMC	1x 3/8"x37,0; 1x 7/16"x37,0; 1x 1/2"x37,0; 1x 9/16"x37,0; 1x 19/32"x37,0; 1x 5/8"x37,0; 1x 11/16"x37,0; 1x 3/4"x37,0; 1x 25/32"x37,0; 1x 13/16"x37,0	
		8794 LC	1x 1/2"x250,0	
		8794 C	1x 1/2"x52,0	
		8784 C2	1x 5/16"x1/2"x50,0	
		851/2 Z PH	1x PH 2x32; 1x PH 3x32	
		855/2 Z PZ	1x PZ 2x32; 1x PZ 3x32	
		867/2 Z TORX®	1x TX 20x35; 1x TX 25x35; 1x TX 30x35; 1x TX 40x35; 1x TX 45x35; 1x TX 50x35	
		840/2 Z	1x 7/32"x30; 1x 1/4"x30; 1x 5/16"x30; 1x 3/8"x30	

## 8100 SC 2 Zyklop Speed Ratchet Set, 1/2" drive, metric

- 37-piece set in a robust metal case

## 8100 SC 2 Zyklop Speed Ratchet Set, 1/2" drive, metric



Code	EAN			
05003645001	4013288 121189			1
		8000 C	1x 1/2"x277,0	
		8790 HMC	1x 10,0x37,0; 1x 11,0x37,0; 1x 12,0x37,0; 1x 13,0x37,0; 1x 14,0x37,0; 1x 15,0x37,0; 1x 16,0x37,0; 1x 17,0x37,0; 1x 18,0x37,0; 1x 19,0x37,0; 1x 20,0x37,0; 1x 21,0x37,0; 1x 22,0x37,0; 1x 24,0x37,0; 1x 27,0x40,0; 1x 30,0x42,0; 1x 32,0x42,0	
		8789 C	1x 1/2"x250,0	
		8794 C	1x 1/2"x52,0	
		8795 C	1x 1/2"x69,0	
		8784 C2	1x 5/16"x1/2"x50,0	
		8796 SC	1x 1/2"x125,0	
		8796 LC	1x 1/2"x250,0	
		851/2 Z PH	1x PH 3x32	
		855/2 Z PZ	1x PZ 3x32	
		867/2 Z TORX®	1x TX 20x35; 1x TX 25x35; 1x TX 30x35; 1x TX 40x35; 1x TX 45x35; 1x TX 50x35; 1x TX 55x35	
		840/2 Z	1x 5x30; 1x 6x30; 1x 8x30; 1x 10x30	

## 8100 SC 4 Zyklop Speed Ratchet Set, 1/2" drive, imperial

- 38-piece set in a robust metal case

### 8100 SC 4 Zyklop Speed Ratchet Set, 1/2" drive, imperial



Code	EAN		
05003647001	121202		1
		<b>8000 C</b> 1x 1/2"x277,0	
		<b>8790 HMC</b> 1x 3/8"x37,0; 1x 7/16"x37,0; 1x 1/2"x37,0; 1x 9/16"x37,0; 1x 19/32"x37,0; 1x 5/8"x37,0; 1x 11/16"x37,0; 1x 3/4"x37,0; 1x 25/32"x37,0; 1x 13/16"x37,0; 1x 7/8"x37,0; 1x 15/16"x37,0; 1x 31/32"x37,0; 1x 1"x40,0; 1x 1 1/16"x40,0; 1x 1 1/8"x40,0; 1x 1 3/16"x42,0; 1x 1 1/4"x42,0	
		<b>8789 C</b> 1x 1/2"x250,0	
		<b>8794 C</b> 1x 1/2"x52,0	
		<b>8795 C</b> 1x 1/2"x69,0	
		<b>8784 C2</b> 1x 5/16"x1/2"x50,0	
		<b>8796 SC</b> 1x 1/2"x125,0	
		<b>8796 LC</b> 1x 1/2"x250,0	
		<b>851/2 Z PH</b> 1x PH 3x32	
		<b>855/2 Z PZ</b> 1x PZ 3x32	
		<b>867/2 Z TORX®</b> 1x TX 20x35; 1x TX 25x35; 1x TX 30x35; 1x TX 40x35; 1x TX 45x35; 1x TX 50x35; 1x TX 55x35	
		<b>840/2 Z</b> 1x 7/32"x30; 1x 1/4"x30; 1x 5/16"x30; 1x 3/8"x30	

## 8000 C Zyklop Speed Ratchet with 1/2" drive

- Combines five different types of a ratchet in one
- Flywheel design and easy-to-grip free-turning sleeve for very high working speeds
- Freely pivoting ratchet head, push button release and left/right switchover
- Fine-tooth design allows a small return angle of 5°
- Can also be used as a screwdriver

### 8000 C Zyklop Speed Ratchet with 1/2" drive



Code	EAN						
05003600001	121882	1/2"	277,0				1

### 8000 C SB Zyklop Speed Ratchet with 1/2" drive



Code	EAN			
05073262001	128058	8000 C	1x 1/2"x277,0	3

## Zyklop Hybrid - longer for more torque

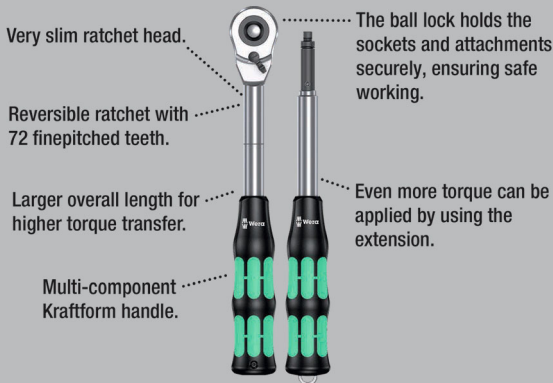

Zyklop Hybrid ratchet set, 1/2" drive, metric. Including Zyklop Hybrid ratchet and Hybrid handle extension.

- Switchover lever for convenient direction change
- Fine-pitched with 72 teeth for a return angle of only 5°
- Compact textile box with high robustness, low weight and volume
- Colour coding of the sockets according to size
- Smooth Twist to Unlock mechanism for a secure fit and simple removal of the sockets

### 8006 SC 1 Zyklop Hybrid Ratchet Set, 1/2" drive, metric

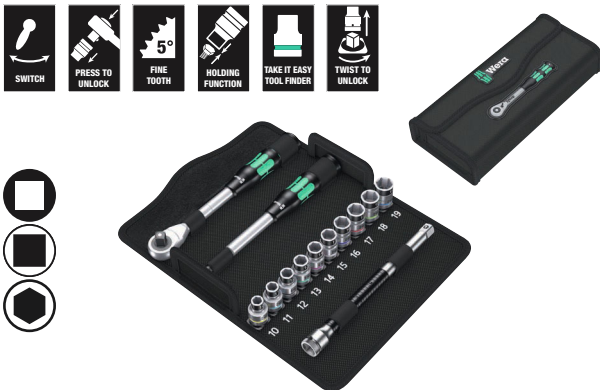

Code	EAN			
05004090001	4013288 182159			1
		8006 C	1x 1/2"x281,0	
		8797 C	1x 271,0	
		8794 LC	1x 1/2"x250,0	
		8790 HMC HF	1x 10,0x37,0; 1x 11,0x37,0; 1x 12,0x37,0; 1x 13,0x37,0; 1x 14,0x37,0; 1x 15,0x37,0; 1x 16,0x37,0; 1x 17,0x37,0; 1x 18,0x37,0; 1x 19,0x37,0	
		Hook and Loop Fastener Strip 240	1x 50,0x240,0	

## Zyklop Hybrid Set

Zyklop Hybrid ratchet set, 1/2" drive, metric. Including Zyklop Hybrid ratchet and Hybrid handle extension, extension and 10 sockets.

- Zyklop Hybrid ratchet with long overall length (leverage effect) and slim ratchet head
- Fine-pitched with 72 teeth for a return angle of only 5°
- Extension with unlocking pin

### Zyklop Hybrid Set

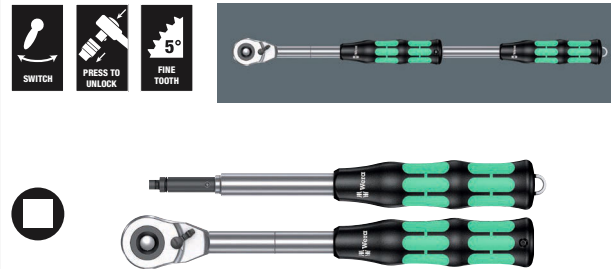

Code	EAN			
05004095001	4013288 184320			1
		8006 C	1x 1/2"x281,0	
		8797 C	1x 271,0	

### 8006 C Zyklop Hybrid Ratchet with switch lever and 1/2" drive

Zyklop Hybrid ratchet with switchover lever and 1/2" drive, low weight, ergonomic Kraftform handle with slim head design, long lever and with an extension option.

### 8006 C Zyklop Hybrid Ratchet with switch lever and 1/2" drive

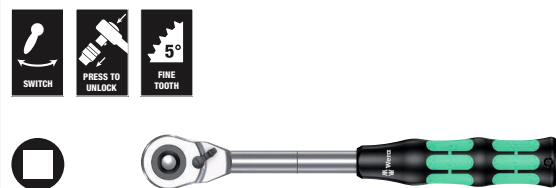

Code	EAN						
05003780001	4013288 184214	1/2"	281,0	34	37		3

### 8797 C Zyklop Hybrid extension

- Can be used with Zyklop Hybrid 8006 C
- To increase the torque to be applied
- Multi-component Kraftform handle optimised to withstand pressure and tensile loads
- With unlocking pin
- Blade out of tough, tempered chrome-molybdenum steel

### 8797 C Zyklop Hybrid extension



	EAN	⌀	ℓ						
Code	4013288	mm	mm						
05003781001	183200	271,0	134,0						1

### Zyklop Metal with push-through square

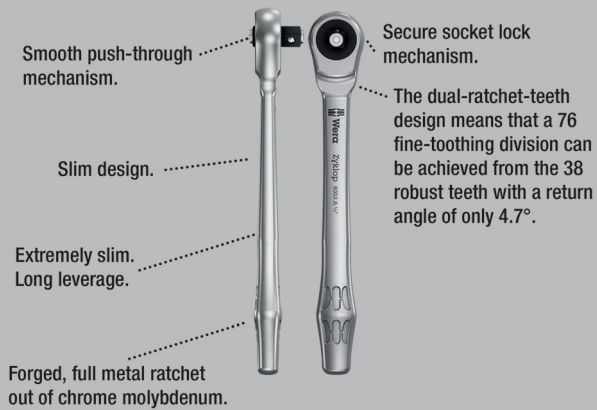

Incredibly compact set arrangement with many tools in a minimum of space. A completely new ratchet set feeling thanks to the unique textile boxes that are very robust and durable.

They can be positioned upright for tidy storage on the workshop shelf. Additional surface protection due to textile outer material. Low weight and volume for simpler mobility.

Take it easy Tool Finder with colour coding according to sizes.

- Extremely slim ratchet with long lever
- Return angle of only 4.7°
- Absolutely smooth switchover of the non-detachable push-through square
- Take it easy tool finder system

### 8100 SC 7 Zyklop Metal Ratchet Set with push-through square, 1/2" drive, metric



Code	EAN			
05004077001	173942			1
		⊖	<b>8003 C</b> 1x 1/2"x281,0	
		⊙	<b>8790 HMC</b> 1x 10,0x37,0; 1x 11,0x37,0; 1x 12,0x37,0; 1x 13,0x37,0; 1x 14,0x37,0; 1x 15,0x37,0; 1x 16,0x37,0; 1x 17,0x37,0; 1x 18,0x37,0; 1x 19,0x37,0	
		⊖	<b>8794 LC</b> 1x 1/2"x250,0	
		⊖	<b>8794 C</b> 1x 1/2"x52,0	
		⊙	<b>8784 C2</b> 1x 9/16"x1/2"x50,0	
		+	<b>851/2 Z PH</b> 1x PH 2x32; 1x PH 3x32	
		⊕	<b>867/2 Z TORX®</b> 1x TX 20x35; 1x TX 25x35; 1x TX 27x35; 1x TX 30x35; 1x TX 40x35; 1x TX 45x35; 1x TX 50x35; 1x TX 55x35	
		⊖	<b>840/2 Z</b> 1x 5x30; 1x 6x30; 1x 8x30; 1x 10x30	

## 8100 SC 10 Zyklop Metal Ratchet Set with push-through square, 1/2" drive, imperial



Code	EAN			
05004080001	4013288 173966			1
		□	8003 C 1x 1/2"x281,0	
		●	8790 HMC 1x 3/8"x37,0; 1x 7/16"x37,0; 1x 1/2"x37,0; 1x 9/16"x37,0; 1x 19/32"x37,0; 1x 5/8"x37,0; 1x 11/16"x37,0; 1x 3/4"x37,0; 1x 25/32"x37,0; 1x 13/16"x37,0	
		◻	8794 LC 1x 1/2"x250,0	
		◻	8794 C 1x 1/2"x52,0	
		●	8784 C2 1x 5/16"x1/2"x50,0	
		+	851/2 Z PH 1x PH 2x32; 1x PH 3x32	
		+	867/2 Z TORX® 1x TX 20x35; 1x TX 25x35; 1x TX 27x35; 1x TX 30x35; 1x TX 40x35; 1x TX 45x35; 1x TX 50x35; 1x TX 55x35	
		○	840/2 Z 1x 7/32"x30; 1x 1/4"x30; 1x 5/16"x30; 1x 3/8"x30	

### 8003 C Zyklop Metal Ratchet with push-through square and 1/2" drive

- Forged, full metal ratchet (chrome-molybdenum); slim design to enable work in very confined spaces.
- The dual-ratchet-teeth design means that a 76 fine-toothing division can be achieved from the 38 robust teeth with a return angle of only 4.7°.
- Absolutely smooth switchover of the non-detachable push-through square
- For 1/2" square sockets with ball lock

### 8003 C Zyklop Metal Ratchet with push-through square and 1/2" drive



Code	EAN	□	mm	mm	mm	
05004063001	4013288 174055	1/2"	281,0	36	37	3

## Zyklop Metal with switch lever

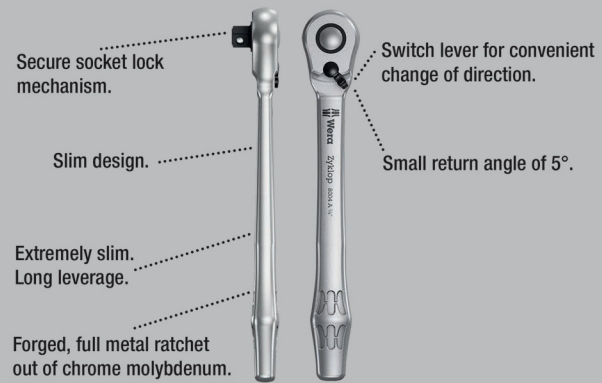

Incredibly compact set arrangement with many tools in a minimum of space. A completely new ratchet set feeling thanks to the unique textile boxes that are very robust and durable.

They can be positioned upright for tidy storage on the workshop shelf. Additional surface protection due to textile outer material. Low weight and volume for simpler mobility.

Take it easy Tool Finder with colour coding according to sizes.

- Convenient direction change thanks to switchover lever
- Extremely slim ratchet with long lever
- Return angle of only 5°

## 8100 SC 8 Zyklop Metal Ratchet Set with switch lever, 1/2" drive, metric



Code	EAN			
05004078001	4013288 173881			1
		□	8004 C 1x 1/2"x281,0	
		●	8790 HMC 1x 10,0x37,0; 1x 11,0x37,0; 1x 12,0x37,0; 1x 13,0x37,0; 1x 14,0x37,0; 1x 15,0x37,0; 1x 16,0x37,0; 1x 17,0x37,0; 1x 18,0x37,0; 1x 19,0x37,0	
		◻	8794 LC 1x 1/2"x250,0	
		◻	8794 C 1x 1/2"x52,0	
		●	8784 C2 1x 5/16"x1/2"x50,0	
		+	851/2 Z PH 1x PH 2x32; 1x PH 3x32	
		+	867/2 Z TORX® 1x TX 20x35; 1x TX 25x35; 1x TX 27x35; 1x TX 30x35; 1x TX 40x35; 1x TX 45x35; 1x TX 50x35; 1x TX 55x35	
		○	840/2 Z 1x 5x30; 1x 6x30; 1x 8x30; 1x 10x30	

### 8100 SC 11 Zyklop Metal Ratchet Set with switch lever, 1/2" drive, imperial



Code	EAN				
05004081001	173973				1
		8004 C	1x 1/2"x281,0		
		8790 HMC	1x 3/8"x37,0; 1x 7/16"x37,0; 1x 1/2"x37,0; 1x 9/16"x37,0; 1x 19/32"x37,0; 1x 5/8"x37,0; 1x 11/16"x37,0; 1x 3/4"x37,0; 1x 25/32"x37,0; 1x 13/16"x37,0		
		8794 LC	1x 1/2"x250,0		
		8794 C	1x 1/2"x52,0		
		8784 C2	1x 5/16"x1/2"x50,0		
		851/2 Z PH	1x PH 2x32; 1x PH 3x32		
		867/2 Z TORX®	1x TX 20x35; 1x TX 25x35; 1x TX 27x35; 1x TX 30x35; 1x TX 40x35; 1x TX 45x35; 1x TX 50x35; 1x TX 55x35		
		840/2 Z	1x 7/32"x30; 1x 1/4"x30; 1x 5/16"x30; 1x 3/8"x30		

### 8004 C Zyklop Metal Ratchet with switch lever and 1/2" drive

- Convenient direction change thanks to switchover lever
- Extremely slim ratchet with long lever
- Return angle of only 5°
- Secure socket locking

### 8004 C Zyklop Metal Ratchet with switch lever and 1/2" drive



Code	EAN						
05004064001	174062	1/2"	281,0	34	37		3

### 8790 C Impaktor socket with 1/2" drive

Impaktor socket for use with electric or pneumatic impact wrenches with 12.5mm = 1/2" drive. The Impaktor technology ensures above-average service life even under extreme conditions.

With Take it easy tool finder with colour coding by size - for easy and fast location of the required tool. With hexagonal profile and grooved socket.

The hexagon profile allows the transmission of high forces and puts less strain on the edges of bolts or screw heads than a double hexagon profile. For hexagon headed bolts, screws and nuts.

- For use with electric or pneumatic powered impact wrenches with 12.5mm = 1/2" drive
- Impaktor technology for above-average service life
- Hexagonal profile enables precise and profile-preserving screwdriving with high power transmission
- With Take it easy tool finder: colour coding by size
- With cross-bore and ring socket for securing locking pin and locking ring of machine-operated tools

### 8790 C Impaktor socket with 1/2" drive



Code	EAN						
05004570001	210012		13,0	38,0	21,0	24,0	1
05004571001	210029		14,0	38,0	22,0	24,0	1
05004572001	210036		15,0	38,0	24,0	24,0	1
05004573001	210043		16,0	38,0	24,0	24,0	1
05004574001	210050		17,0	38,0	26,0	26,0	1
05004575001	210067		18,0	38,0	28,0	28,0	1
05004576001	210074		19,0	38,0	28,0	28,0	1
05004577001	210081		20,0	38,0	26,0	30,0	1
05004578001	210098		21,0	38,0	26,0	30,0	1

### Belt C Impaktor 1 socket set, 1/2" drive

Robust textile belt in the typical Wera design with nine Impaktor socket wrench plug-ins for missions in confined spaces. A smooth Twist to Unlock mechanism ensures a secure fit and simple removal of the sockets. Including snap hook for attachment on belt loops or bags.

With fleece backing and hook and loop fastener strips for easy attachment e.g. on wall, shelf, workshop trolley and Wera 2go tool transport system. Impaktor sockets for use with electric or pneumatic powered impact wrenches with 12.5mm = 1/2" drive.

Impaktor technology ensures above-average service life, even under extreme conditions. With Take it easy tool finder with colour coding by size - for easy and fast location of the required tool. With hexagonal profile and grooved socket.

The hexagon profile allows the transmission of high forces and puts less strain on the edges of bolts or screw heads than a double hexagon profile. For external hexagonal bolts and sockets.

- 9-piece socket set on robust textile belt 1/2"
- Smooth Twist to Unlock mechanism for a secure fit and simple removal of the sockets
- Particularly suitable for use with customary impact drivers
- With Take it easy tool finder: colour coding by size
- Suitable for attachment to a wall, shelf, tool trolley and to the Wera 2go System

### Magnetic socket rail C Impaktor 1 socket set, 1/2" drive

Socket rail with 9 Impaktor sockets for use with electric or pneumatic wrenches with 12.5 mm = 1/2" drive.

The Impaktor technology ensures a higher-than-average service life even at extreme requirements.

The hexagon profile used allows a high power transmission while simultaneously being precise and protecting the profile.

With Take it easy tool finder with colour coding by size - to help you find the required tool quickly and easily.

The rail allows temporary attachment to metallic surfaces and, with its twist-to-unlock function, ensures secure locking and unlocking of the sockets.

- 9-piece socket set on socket rail, 1/2"
- For use with electric or pneumatic powered impact wrenches with 12.5mm = 1/2" drive
- Impaktor technology for above-average service life
- Hexagonal profile enables precise and profile-preserving screwdriving with high power transmission
- With cross-bore and ring socket for securing locking pin and locking ring of machine-operated tools

#### Belt C Impaktor 1 socket set, 1/2" drive



Code	EAN		
05004580001	210104		1
		● 8790 C Impaktor 1x 13,0x38,0; 1x 14,0x38,0; 1x 15,0x38,0; 1x 16,0x38,0; 1x 17,0x38,0; 1x 18,0x38,0; 1x 19,0x38,0; 1x 20,0x38,0; 1x 21,0x38,0	
		Belt C Impaktor 0/9 1x 71,0x210,0	
		Hook and Loop Fastener Strip 30 1x 30,0x200,0	

#### Magnetic socket rail C Impaktor 1 socket set, 1/2" drive

Code	EAN		
05005490001	223289		1
		● 8790 C Impaktor 1x 13,0x38,0; 1x 14,0x38,0; 1x 15,0x38,0; 1x 16,0x38,0; 1x 17,0x38,0; 1x 18,0x38,0; 1x 19,0x38,0; 1x 20,0x38,0; 1x 21,0x38,0	
		9602 1x 30,0x370,0	

### 8790 C Impaktor Deep socket with 1/2" drive

Long Impaktor socket for use with electric or pneumatic wrenches with 12.5 mm = 1/2" drive. For use even at low lying couplings and protruding thread rods.

The Impaktor technology ensures a higher-than-average service life even at extreme requirements. With Take it easy tool finder with colour coding by size – to help you find the required tool quickly and easily.

With hexagon profile with socket and well. With hexagon profile with socket and well. The hexagon profile enables the transmission of high forces and loads the edges of the bolt or the screw head less than a double hexagon profile. For external hexagon bolts and screws.

- Robust Impaktor sockets for extremely high stress; for use with electric or pneumatic wrenches with 12.5 mm = 1/2" drive
- Long socket wrenches for low lying couplings, also suitable for fitting, protruding thread rods in confined spaces
- With cross-bore and ring socket for securing locking pin and locking ring of machine-operated tools

### 8790 C Impaktor Deep socket with 1/2" drive



Code	EAN		mm	mm	mm	mm	
05004830001	221926		13,0	83,0	21,0	24,0	1
05004831001	221933		14,0	83,0	22,0	24,0	1
05004832001	221940		15,0	83,0	24,0	24,0	1
05004833001	221957		16,0	83,0	24,0	24,0	1
05004834001	221964		17,0	83,0	26,0	26,0	1
05004835001	221995		18,0	83,0	28,0	28,0	1
05004836001	222008		19,0	83,0	28,0	28,0	1
05004837001	222015		21,0	83,0	30,0	27,0	1
05004838001	222107		22,0	83,0	32,0	28,0	1
05004839001	222114		24,0	83,0	34,0	30,0	1
05004840001	222121		27,0	83,0	38,0	33,0	1

### 8790 C Impaktor Deep Set 1

Set with 11 Impaktor Deep sockets for use with electric or pneumatic wrenches with 12.5 mm = 1/2" drive. Long design for low-lying couplings and protruding thread rods.

The Impaktor technology ensures a higher-than-average service life even at extreme requirements.

The hexagon profile used allows a high power transmission while simultaneously being precise and protecting the profile. With Take it easy tool finder with colour coding by size - for quick and easy identification of the required tool .

- Long 1/2" sockets for low-profile-fitting screw connections in tight construction spaces and for protruding threaded rods
- For use with electric or pneumatic powered impact wrenches with 12.5mm = 1/2" drive
- Impaktor technology for above-average service life
- Hexagonal profile enables precise and profile-preserving screwdriving with high power transmission
- With cross-bore and ring socket for securing locking pin and locking ring of machine-operated tools
- With Take it easy tool finder: colour coding by size
- In a robust textile box

### 8790 C Impaktor Deep Set 1

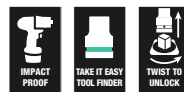

Code	EAN		
05004841001	224088		1
		<b>8790 C Impaktor Deep</b> 1x 13,0x83,0; 1x 14,0x83,0; 1x 15,0x83,0; 1x 16,0x83,0; 1x 17,0x83,0; 1x 18,0x83,0; 1x 19,0x83,0; 1x 21,0x83,0; 1x 22,0x83,0; 1x 24,0x83,0; 1x 27,0x83,0	



## 8790 HMC Zyklop socket with 1/2" drive

- 1/2" inch Zyklop socket
- For manual and power tool operations (non-impact)
- Knurling at lower end to enable easy gripping when used in manual applications
- Equipped with ball stop groove
- Take it easy tool finder with colour coding according to sizes

### 8790 HMC Zyklop socket with 1/2" drive



Code	EAN		mm	mm	mm	mm	mm	
05003601001	120618		10,0	37,0	15,5	24,0	1	
05003602001	120625		11,0	37,0	16,5	24,0	1	
05003603001	120656		12,0	37,0	17,5	24,0	1	
05003604001	120663		13,0	37,0	19,0	24,0	1	
05003605001	120670		14,0	37,0	20,0	24,0	1	
05003606001	120687		15,0	37,0	21,0	24,0	1	
05003607001	120694		16,0	37,0	22,5	24,0	1	
05003608001	120700		17,0	37,0	24,0	26,0	1	
05003609001	120717		18,0	37,0	25,0	26,0	1	
05003610001	120724		19,0	37,0	26,5	26,0	1	
05003611001	120731		20,0	37,0	28,0	26,0	1	
05003612001	120748		21,0	37,0	29,0	26,0	1	
05003613001	120755		22,0	37,0	30,5	26,0	1	
05003614001	120762		24,0	37,0	33,0	28,0	1	
05003615001	120779		27,0	40,0	36,5	32,0	1	
05003616001	120786		30,0	42,0	40,0	34,0	1	
05003617001	120793		32,0	42,0	42,0	36,0	1	
05003618001	120809			37,0	15,5	24,0	1	3/8"
05003619001	120816			37,0	16,5	24,0	1	7/16"
05003620001	120823			37,0	19,0	24,0	1	1/2"
05003621001	120830			37,0	20,0	24,0	1	9/16"
05003622001	120847			37,0	21,0	24,0	1	19/32"
05003623001	120854			37,0	22,5	24,0	1	5/8"
05003624001	120861			37,0	25,5	26,0	1	11/16"
05003625001	120878			37,0	26,5	26,0	1	3/4"
05003626001	120885			37,0	28,0	26,0	1	25/32"
05003627001	120892			37,0	29,0	26,0	1	13/16"
05003628001	120908			37,0	30,5	26,0	1	7/8"
05003629001	120915			37,0	33,0	28,0	1	15/16"
05003630001	120922			37,0	33,0	28,0	1	31/32"
05003631001	120939			40,0	36,5	32,0	1	1"
05003632001	120946			40,0	36,5	32,0	1	1 1/16"
05003633001	120953			40,0	40,0	34,0	1	1 1/8"
05003634001	120960			42,0	40,0	34,0	1	1 3/16"
05003635001	120977			42,0	42,0	36,0	1	1 1/4"

## 8790 HMC HF Zyklop socket with 1/2" drive with holding function

- Socket (non-impact) for manual or power tool operations
- The holding function holds screws securely on the tool
- Take it easy tool finder with colour coding according to sizes
- Chrome vanadium steel, matt chrome-plated
- Equipped with ball stop groove, knurling at lower end for better gripping

### 8790 HMC HF Zyklop socket with 1/2" drive with holding function



Code	EAN		mm	mm	mm	mm	mm	mm	
05003730001	180957		10,0	37,0	17,8	23,5	10,4	1	
05003731001	180964		11,0	37,0	18,8	23,5	10,4	1	
05003732001	180971		12,0	37,0	20,4	23,5	11,4	1	
05003733001	181022		13,0	37,0	21,4	23,5	11,4	1	
05003734001	181039		14,0	37,0	22,6	23,5	11,4	1	
05003735001	181046		15,0	37,0	23,6	23,5	12,0	1	
05003736001	181053		16,0	37,0	25,0	23,5	12,0	1	
05003737001	181060		17,0	37,0	26,8	23,5	12,5	1	
05003738001	181077		18,0	37,0	28,0	23,5	12,5	1	
05003739001	181084		19,0	37,0	29,2	23,5	14,0	1	

### Belt C 1 Zyklop socket set with holding function, 1/2" drive

Typically Wera designed robust textile belt with 6 sockets taking up minimal space. A smooth Twist to Unlock mechanism ensures a secure fit and simple removal of the sockets.

Comes with Take it easy Tool Finder with colour coding according to size to enable the right tool to be selected easily and quickly.

Includes a snap hook for secure fastening to a belt loop or pocket. Sockets with holding function for particularly convenient screwdriving with reduced risk of losing the screw when approaching the workpiece.

Supplied with a non-woven reverse side and hook and loop strips for simple attachment e.g. to a wall, shelf, tool trolley and to the Wera 2go tool transport system.

- 7-piece socket set on a robust textile belt, 1/2"
- Sockets with holding function for screws/bolts/nuts
- Smooth Twist to Unlock mechanism for a secure fit and simple removal of the sockets
- Take it easy tool finder with colour coding according to sizes
- Suitable for attachment to a wall, shelf, tool trolley and to the Wera 2go System

### Belt C 1 Zyklop socket set with holding function, 1/2" drive



Code	EAN		
05003995001	204400		1
		● <b>8790 HMC HF</b> 1x 10,0x37,0; 1x 13,0x37,0; 1x 15,0x37,0; 1x 16,0x37,0; 1x 17,0x37,0; 1x 19,0x37,0	
		<b>Nut Extractor</b> 1x 14,0x43,0	
		<b>Belt C 0/6</b> 1x 45,0x275,0	
		<b>Hook and Loop Fastener Strip 30</b> 1x 30,0x200,0	

### Magnetic socket rail C Imperial 1 Zyklop socket set, 1/2" drive, imperial

Socket rail with 9 manual and machine socket wrench inserts (non-impact), 1/2". A smooth rotary mechanism allows a secure hold and easy access of the sockets.

With Take it easy tool finder with colour coding by size - to help you find the required tool quickly and easily.

The rail allows temporary attachment to metallic surfaces and, with its twist-to-unlock function, ensures secure locking and unlocking of the sockets.

- 9-piece socket set on socket rail, 1/2"
- Rail with secure bit mounting and yet easy removal (twist-to-unlock) for temporary attachment on wall, shelf or workshop trolley
- Smooth Twist to Unlock mechanism for a secure fit and simple removal of the sockets
- With Take it easy tool finder: colour coding by size

### Magnetic socket rail C Imperial 1 Zyklop socket set, 1/2" drive, imperial



Code	EAN		
05005480001	223296		1
		● <b>8790 HMC</b> 1x 3/8"x37,0; 1x 7/16"x37,0; 1x 1/2"x37,0; 1x 9/16"x37,0; 1x 5/8"x37,0; 1x 11/16"x37,0; 1x 3/4"x37,0; 1x 7/8"x37,0; 1x 1"x40,0	
		<b>9602</b> 1x 30,0x370,0	

### 8790 HMC HF 1 Zyklop socket set with 1/2" drive, with holding function

Socket set with holding function for particularly convenient screwdriving with reduced risk of losing the screw when addressing the workpiece.

- Compact textile box with high robustness, low weight and volume
- Bit socket (non-impact) for manual or power tool operations
- The holding function holds screws securely on the tool
- Take it easy tool finder with colour coding according to sizes
- Knurling on lower socket end for more grip when used manually

### 8790 HMC HF 1 Zyklop socket set with 1/2" drive, with holding function



Code	EAN			
05004203001	184238			1
		<b>8790 HMC HF</b> 1x 10,0x37,0; 1x 11,0x37,0; 1x 12,0x37,0; 1x 13,0x37,0; 1x 14,0x37,0; 1x 15,0x37,0; 1x 16,0x37,0; 1x 17,0x37,0; 1x 18,0x37,0; 1x 19,0x37,0		
		<b>Hook and Loop Fastener Strip 120</b> 1x 50,0x120,0		

### 8790 C Wheel Impaktor Socket with 1/2" drive

Impaktor socket, 1/2", for use with impact wrenches, with rotating smooth plastic sleeve for higher working speed, better accuracy during screwdriving and additional rim protection.

- For use with electric or pneumatic impact wrenches with 12.5mm = 1/2" drive
- Robust Impaktor design for extremely high stresses
- Hexagonal profile enables precise and profile-preserving screwdriving with high power transmission
- Take it easy tool finder with colour coding according to sizes

### 8790 C Wheel Impaktor Socket with 1/2" drive



Code	EAN						
05004590001	210739		17,0	85,0	30,0		1
05004591001	210746		19,0	85,0	30,0		1
05004592001	210753		21,0	85,0	32,0		1

### Wheel Impaktor C Set 1 Socket set, 1/2" drive

Three 1/2" Impaktor socket wrench plug-ins, for use with impact wrenches; with rotating smooth plastic sleeve for higher working speed and additional rim protection. Internal plastic insert to protect the wheel bolt surface.

#### Wheel Impaktor C Set 1 Socket set, 1/2" drive



Code		EAN		
05004595001		210760	4013288	1
			8790 C Wheel Impaktor	
			1x 17,0x85,0x30,0; 1x 19,0x85,0x30,0;	
			1x 21,0x85,0x32,0	

### 8790 HMC Deep socket with 1/2" drive

Long 1/2" hand and machine socket (ISO 2725 part 3) with ball intercept ring; for external hexagonal bolts and sockets. For use in manual and machine operation (non-impact), even with low-lying screwdriving and protruding threaded rods.

With Take it easy tool finder with colour coding by size - for easy and fast location of the required tool. Easy to grasp even with oily hands.

The hexagon profile allows the transmission of high forces and puts less strain on the edges of bolts or screw heads than a double hexagon profile. Fine-toothed ratchets also make the use of a double hexagon profile superfluous, even in confined spaces, thanks to their small back-pivoting angle.

- Long sockets for low-lying screwdriving, often even with protruding threaded rods in small spaces
- Hexagonal profile enables precise bolting with high power transmission and preserves the profile
- Knurling at lower end to enable easy gripping when used in manual applications
- Made of matt chromed chrome-vanadium

#### 8790 HMC Deep socket with 1/2" drive



Code	EAN	mm	mm	mm	mm	
05004550001	210562	10,0	83,0	15,5	21,8	1
05004551001	210579	11,0	83,0	16,7	22,0	1
05004552001	210586	12,0	83,0	18,0	22,0	1
05004553001	210593	13,0	83,0	19,2	22,0	1
05004554001	210609	14,0	83,0	20,5	22,0	1
05004555001	210616	15,0	83,0	22,0	20,7	1
05004556001	210623	16,0	83,0	22,0	20,7	1
05004557001	210630	17,0	83,0	24,0	22,2	1
05004558001	210647	18,0	83,0	26,0	23,2	1
05004559001	210654	19,0	83,0	26,0	23,2	1
05004560001	210661	20,0	83,0	28,0	25,2	1
05004561001	210678	21,0	83,0	28,0	25,2	1
05004562001	210685	22,0	83,0	30,0	27,2	1
05004563001	210692	24,0	83,0	32,0	28,2	1

### Belt C Deep 1 socket set, 1/2" drive

- 6-piece socket set on robust textile belt, 1/2"
- Smooth Twist to Unlock mechanism for a secure fit and simple removal of the sockets
- Long 1/2" socket for low-profile-fitting screw connections in tight construction spaces and for protruding threaded rods
- Hexagonal profile enables precise and profile-preserving screwdriving with high power transmission
- Take it easy tool finder with colour coding according to sizes

### Belt C Deep 1 socket set, 1/2" drive



Code		EAN		
		4013288		
05004565001	210708			1
			<b>8790 HMC Deep</b> 1x 10,0x83,0; 1x 13,0x83,0; 1x 15,0x83,0; 1x 16,0x83,0; 1x 17,0x83,0; 1x 19,0x83,0	
			<b>Belt C 0/6</b> 1x 45,0x275,0	
			<b>Hook and Loop Fastener Strip 30</b> 1x 30,0x200,0	

### Magnetic socket rail C Deep 1 socket set, 1/2" drive

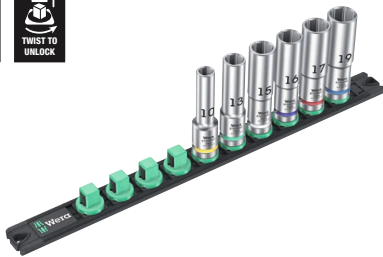

Code		EAN		
		4013288		
05005470001	223272			1
			<b>8790 HMC Deep</b> 1x 10,0x83,0; 1x 13,0x83,0; 1x 15,0x83,0; 1x 16,0x83,0; 1x 17,0x83,0; 1x 19,0x83,0	
			<b>9602</b> 1x 30,0x370,0	

### 8790 HMC Deep Socket wrench insert with cutout shaft, with 1/2" drive

Socket for external hexagon bolts and screws, 1/2", long design. Slotted on the side for installing panel connectors.

With ball stop groove. For manual and machine-operated tools (non-impact).

- Slotted on the side for installing top- and side-wired panel connectors

### 8790 HMC Deep Socket wrench insert with cutout shaft, with 1/2" drive



	EAN							
Code	4013288	mm	mm	mm	mm	mm		
05138007001	233547	17,0	76,0	24,0	24,0	10,0		1

### 8767 C HF TORX® Zyklop bit socket with 1/2" drive with holding function

- Bit socket (non-impact) for manual or machine tool operations
- The holding function holds screws securely on the tool
- Take it easy tool finder with colour coding according to sizes
- Knurling on lower end for more grip when used manually
- Chrome vanadium steel, matt chrome-plated

### 8767 C HF TORX® Zyklop bit socket with 1/2" drive with holding function

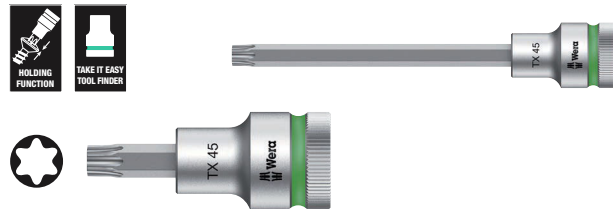

Code	EAN			mm	mm	mm	mm	
05003830001	183316		TX 20	60,0	16,4	23,5	21,5	1
05003850001	183545		TX 20	140,0	16,4	23,5	101,5	1
05003831001	183323		TX 25	60,0	16,4	23,5	21,5	1
05003851001	183552		TX 25	140,0	16,4	23,5	101,5	1
05003832001	183330		TX 27	60,0	16,4	23,5	21,5	1
05003852001	183569		TX 27	140,0	16,4	23,5	101,5	1
05003833001	183347		TX 30	60,0	16,4	23,5	21,5	1
05003853001	183576		TX 30	140,0	16,4	23,5	101,5	1
05003834001	183354		TX 40	60,0	16,4	23,5	21,5	1
05003854001	183583		TX 40	140,0	16,4	23,5	101,5	1
05003835001	183361		TX 45	60,0	16,4	23,5	21,5	1
05003855001	184443		TX 45	140,0	16,4	23,5	101,5	1
05003836001	183378		TX 50	60,0	21,4	23,5	21,5	1
05003856001	183606		TX 50	140,0	21,4	23,5	101,5	1
05003837001	183385		TX 55	60,0	21,4	23,5	21,5	1
05003857001	183613		TX 55	140,0	21,4	23,5	101,5	1
05003838001	183392		TX 60	60,0	21,4	23,5	21,5	1
05003858001	183620		TX 60	140,0	21,4	23,5	101,5	1

### Belt C 3 TORX® HF Zyklop bit socket set with holding function, 1/2" drive

Typically Wera designed robust textile belt with 6 in-hex bit-sockets taking up minimal space. A smooth Twist to Unlock mechanism ensures a secure fit and simple removal of the sockets.

Comes with Take it easy Tool Finder with colour coding according to size to enable the right tool to be selected easily and quickly. Includes a snap hook for secure fastening to a belt loop or pocket.

Supplied with a nonwoven reverse side and hook and loop strips for simple attachment e.g. to a wall, shelf, tool trolley and to the Wera 2go tool transport system.

- 6-piece socket set on robust textile belt, 1/2"
- Bit-sockets with all the advantages of the Wera bit technology
- Bit-sockets with holding function for screws/bolts
- Smooth Twist to Unlock mechanism for a secure fit and simple removal of the sockets
- Suitable for attachment to a wall, shelf, tool trolley and to the Wera 2go System

### Belt C 3 TORX® HF Zyklop bit socket set with holding function, 1/2" drive



Code	EAN		
05003997001	204882		1
		<b>8767 C HF</b> 1x TX 25x60,0; 1x TX 30x60,0; 1x TX 40x60,0; 1x TX 45x60,0; 1x TX 50x60,0; 1x TX 55x60,0	
		<b>Belt C 0/6</b> 1x 45,0x275,0	
		<b>Hook and Loop Fastener Strip 30</b> 1x 30,0x200,0	

**Magnetic socket rail C 4 Zyklop socket set, 1/2" drive**  
 Socket rail with 9 manual and machine sockets (non-impact), 1/2". A smooth rotary mechanism allows a secure hold and easy access of the sockets.

With Take it easy tool finder with colour coding by size - to help you find the required tool quickly and easily.

The rail allows temporary attachment to metallic surfaces and, with its twist-to-unlock function, ensures secure locking and unlocking of the sockets.

- 9-piece socket set on socket rail, 1/2"
- Rail with secure bit mounting and yet easy removal (twist-to-unlock) for temporary attachment on wall, shelf or workshop trolley
- Smooth Twist to Unlock mechanism for a secure fit and simple removal of the sockets
- With Take it easy tool finder: colour coding by size

**Magnetic socket rail C 4 Zyklop socket set, 1/2" drive**



Code	EAN		
05005460001	4013288 223265		1
		● <b>8790 HMC</b> 1x 10,0x37,0; 1x 12,0x37,0; 1x 13,0x37,0; 1x 14,0x37,0; 1x 15,0x37,0; 1x 16,0x37,0; 1x 17,0x37,0; 1x 18,0x37,0; 1x 19,0x37,0	
		<b>9602</b> 1x 30,0x370,0	

**8767 C TORX® HF 1 Zyklop bit socket set with 1/2" drive, with holding function**

- Compact textile box with high robustness, low weight and volume

**8767 C TORX® HF 1 Zyklop bit socket set with 1/2" drive, with holding function**



Code	EAN		
05004202001	4013288 184276		1
		● <b>8767 C HF</b> 1x TX 20x60,0; 1x TX 25x60,0; 1x TX 27x60,0; 1x TX 30x60,0; 1x TX 40x60,0; 1x TX 45x60,0; 1x TX 50x60,0; 1x TX 55x60,0; 1x TX 60x60,0	

**8767 C TORX® HF 2 Zyklop bit socket set with 1/2" drive, with holding function**

- Compact textile box with high robustness, low weight and volume
- Long version

**8767 C TORX® HF 2 Zyklop bit socket set with 1/2" drive, with holding function**



Code	EAN		
05004211001	4013288 185464		1
		● <b>8767 C HF</b> 1x TX 20x140,0; 1x TX 25x140,0; 1x TX 27x140,0; 1x TX 30x140,0; 1x TX 40x140,0; 1x TX 45x140,0	
		<b>Hook and Loop Fastener Strip 120</b> 1x 50,0x120,0	

### 8767 C TORX® HF 3 Zyklop bit socket set with 1/2" drive, with holding function

- Compact textile box with high robustness, low weight and volume
- Long version

### 8767 C TORX® HF 3 Zyklop bit socket set with 1/2" drive, with holding function



Code	EAN		
05004212001	185471		1
		<b>8767 C HF</b> 1x TX 20x140,0; 1x TX 25x140,0; 1x TX 27x140,0; 1x TX 30x140,0; 1x TX 40x140,0; 1x TX 45x140,0; 1x TX 50x140,0; 1x TX 55x140,0; 1x TX 60x140,0	
		<b>Hook and Loop Fastener Strip 120</b> 1x 50,0x120,0	

### 8740 C HF Zyklop bit socket with 1/2" drive with holding function

- Bit socket (non-impact) for manual or machine tool operations
- The holding function holds screws securely on the tool
- Take it easy tool finder with colour coding according to sizes
- Knurling on lower end for more grip when used manually
- Chrome vanadium steel, matt chrome-plated

### 8740 C HF Zyklop bit socket with 1/2" drive with holding function



Code	EAN		mm	mm	mm	mm	mm	
05003820001	183217		4,0	60,0	14,0	21,5	21,5	1
05003840001	183484		4,0	140,0	14,0	21,5	101,5	1
05003821001	183224		5,0	60,0	14,0	21,5	21,5	1
05003841001	183491		5,0	140,0	14,0	21,5	101,5	1
05003822001	183231		6,0	60,0	14,0	21,5	21,5	1
05003842001	183507		6,0	140,0	14,0	21,5	101,5	1
05003823001	183248		7,0	60,0	14,0	23,5	21,5	1
05003843001	183514		7,0	140,0	14,0	23,5	101,5	1
05003824001	183255		8,0	60,0	16,0	23,5	21,5	1
05003844001	183521		8,0	140,0	16,0	23,5	101,5	1
05003825001	183262		10,0	60,0	16,0	23,5	21,5	1
05003845001	183538		10,0	140,0	16,0	23,5	101,5	1
05003826001	183279		12,0	60,0	21,0	23,5	23,0	1
05003827001	183286		14,0	60,0	22,0	23,5	23,0	1
05003828001	183293		17,0	60,0	24,5	25,5	23,0	1
05003829001	183309		19,0	60,0	26,5	27,5	23,0	1



### Belt C 2 Zyklop In-Hex-Plus bit socket set with holding function, 1/2" drive

Typically Wera designed robust textile belt with 6 in-hex bit-sockets taking up minimal space.

A smooth Twist to Unlock mechanism ensures a secure fit and simple removal of the sockets.

Comes with Take it easy Tool Finder with colour coding according to size to enable the right tool to be selected easily and quickly. Includes a snap hook for secure fastening to a belt loop or pocket.

Supplied with a nonwoven reverse side and hook and loop strips for simple attachment e.g. to a wall, shelf, tool trolley and to the Wera 2go tool transport system.

- 6-piece socket set on robust textile belt, 1/2"
- Bit-sockets with all the advantages of the Wera bit technology
- Bit-sockets with holding function for screws/bolts
- Smooth Twist to Unlock mechanism for a secure fit and simple removal of the sockets
- Suitable for attachment to a wall, shelf, tool trolley and to the Wera 2go System

### Belt C 2 Zyklop In-Hex-Plus bit socket set with holding function, 1/2" drive



<b>Code</b>	<b>EAN</b>		
05003996001	4013288 204424		1
		○ <b>8740 C HF</b> 1x 4,0x60,0; 1x 5,0x60,0; 1x 6,0x60,0; 1x 7,0x60,0; 1x 8,0x60,0; 1x 10,0x60,0	
		<b>Belt C 0/6</b> 1x 45,0x275,0	
		<b>Hook and Loop Fastener Strip 30</b> 1x 30,0x200,0	

### 8740 C HF 1 Zyklop bit socket set with 1/2" drive, with holding function

- Compact textile box with high robustness, low weight and volume

### 8740 C HF 1 Zyklop bit socket set with 1/2" drive, with holding function



<b>Code</b>	<b>EAN</b>		
05004201001	4013288 184283		1
		○ <b>8740 C HF</b> 1x 4,0x60,0; 1x 5,0x60,0; 1x 6,0x60,0; 1x 7,0x60,0; 1x 8,0x60,0; 1x 10,0x60,0; 1x 12,0x60,0; 1x 14,0x60,0; 1x 17,0x60,0	
		<b>Hook and Loop Fastener Strip 120</b> 1x 50,0x120,0	

### 8740 C HF 2 Zyklop bit socket set with 1/2" drive, with holding function

- Compact textile box with high robustness, low weight and volume
- Long version

### 8740 C HF 2 Zyklop bit socket set with 1/2" drive, with holding function



<b>Code</b>	<b>EAN</b>		
05004210001	4013288 185457		1
		○ <b>8740 C HF</b> 1x 4,0x140,0; 1x 5,0x140,0; 1x 6,0x140,0; 1x 7,0x140,0; 1x 8,0x140,0; 1x 10,0x140,0	
		<b>Hook and Loop Fastener Strip 120</b> 1x 50,0x120,0	

### 9529 C SB 1/2" Step wrench

- 5 steps (3/8", 7/16", 1/2", 16 and 21 mm)
- For 1/2" ratchets
- Chrome vanadium steel

### 9529 C SB 1/2" Step wrench

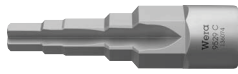

Code	EAN	mm							
05136074001	228390	88,0							1

### 8796 LC Zyklop „flexible-lock“ extension with free-turning sleeve, long, 1/2"

- For 1/2" square sockets with ball lock
- Flexible lock system for either locking or rapid exchange of the attached tool
- With free-turning sleeve for rapid tightening and loosening of screws and nuts

### 8796 LC Zyklop „flexible-lock“ extension with free-turning sleeve, long, 1/2"



Code	EAN	mm							
05003643001	121462	1/2"	250,0						1

### 8796 SC Zyklop „flexible-lock“ extension with free-turning sleeve, short, 1/2"

- For 1/2" square sockets with ball lock
- Flexible lock system for either locking or rapid exchange of the attached tool
- With free-turning sleeve for rapid tightening and loosening of screws and nuts

### 8796 SC Zyklop „flexible-lock“ extension with free-turning sleeve, short, 1/2"



Code	EAN	mm							
05003642001	121455	1/2"	125,0						1

### 8794 LC Zyklop extension with free-turning sleeve, long, 1/2"

Wera Zyklop extension with easy-to-grip free-turning sleeve for rapid tightening and loosening of screws and nuts. Out of high quality chrome vanadium steel, matt chrome-plated.

### 8794 LC Zyklop extension with free-turning sleeve, long, 1/2"



Code	EAN	mm							
05003638001	121431	1/2"	250,0						1

**8794 SC Zyklop extension with free-turning sleeve, short, 1/2"**  
 Wera Zyklop extension with easy-to-grip free-turning sleeve for rapid tightening and loosening of screws and nuts. Out of high quality chrome vanadium steel, matt chrome-plated.

**8794 SC Zyklop extension with free-turning sleeve, short, 1/2"**



Code	EAN	□	⌀						
05003637001	121424	1/2"	125,0						1

**8789 C Zyklop sliding T-handle, 1/2"**  
 Wera Zyklop T-handle for higher torque transfer. For 1/2" square sockets with ball lock. Adjustable drive for more flexible usage. Out of high quality chrome vanadium steel, matt chrome-plated.

**8789 C Zyklop sliding T-handle, 1/2"**



Code	EAN	□	⌀						
05003636001	121530	1/2"	250,0						3

**8795 C Zyklop universal joint, 1/2"**  
 Wera Zyklop universal joint for 1/2" square sockets with ball lock.

**8795 C Zyklop universal joint, 1/2"**



Code	EAN	□	⌀						
05003640001	121547	1/2"	69,0						1

**8794 C Zyklop wobble extension, 1/2"**  
 Wobble extension for the Wera Zyklop. Swivel angle of 15° in all directions. This ensures rapid and precise work even in confined working situations.

**8794 C Zyklop wobble extension, 1/2"**



Code	EAN	□	⌀						
05003639001	121448	1/2"	52,0						1

**8784 C2 Zyklop bit adaptor, 1/2", 5/16"**  
 Adaptor from square to hex. For 5/16" hex bits as per DIN ISO 1173-C 8 and Wera connecting series 2; with quick-release chuck.

**8784 C2 Zyklop bit adaptor, 1/2", 5/16"**



Code	EAN	⬡	□	⌀					
05003641001	119353	5/16"	1/2"	50,0					1

### 8009 Zyklop Pocket Set 1

Compact Zyklop ratchet with bit magazine for the pocket. Magnetic direct mounting for 1/4" bits and 3/8" sockets. Rapid tool change thanks to the non-locking mounting.

As the head is lockable at 0°, 15° and 90°, the tool can be used as a ratchet and as a ratchet screwdriver. The fine tooththing with 72 teeth allows for a low return angle of 5°.

Wide range of applications thanks to 12 bits integrated in the handle. The robust ratchet mechanism allows for ample torque. Perfect combination of a Zyklop ratchet with a 12-piece screwdriver set.

- Compact Zyklop ratchet with integrated bit magazine
- Thanks to it's clever design the ratchet head doubles up as both a 3/8" square drive ratchet for sockets, and integral 1/4" hexagon drive for screwdriver bits
- Freely pivoting ratchet head with 5 predefined locking positions
- Fine tooth reversible ratchet (72 teeth) for a low return angle of only 5°
- Captive and freely swivelling bit magazine for easy removal and secure storage of the bits

### 8009 Zyklop Pocket Set 1



Code	EAN		
05004280001	4013288 221834		1
		<input type="checkbox"/> <b>8009</b> 1x 3/8"x1/4"x133,0	
		<input checked="" type="checkbox"/> <b>851/1 BTZ</b> 1x PH 1x25; 1x PH 2x25	
		<input checked="" type="checkbox"/> <b>855/1 BTZ</b> 1x PZ 1x25; 1x PZ 2x25	
		<input checked="" type="checkbox"/> <b>867/1 TORX® BTZ</b> 1x TX 10x25; 1x TX 15x25; 1x TX 20x25; 1x TX 25x25	
		<input checked="" type="checkbox"/> <b>840/1 BTZ</b> 1x 3,0x25; 1x 4,0x25; 1x 5,0x25; 1x 6,0x25	

### 8009 Zyklop Pocket Imperial Set 1



Code	EAN		
05004282001	4013288 221841		1
		<input checked="" type="checkbox"/> <b>8009</b> 1x 3/8"x1/4"x133,0	
		<input checked="" type="checkbox"/> <b>851/1 BTZ</b> 1x PH 1x25; 1x PH 2x25	
		<input checked="" type="checkbox"/> <b>867/1 TORX® BTZ</b> 1x TX 10x25; 1x TX 15x25; 1x TX 20x25; 1x TX 25x25	
		<input checked="" type="checkbox"/> <b>840/1 Z</b> 1x 1/8"x25; 1x 5/32"x25; 1x 3/16"x25; 1x 1/4"x25	
		<input type="checkbox"/> <b>868/1 Z</b> 1x # 1x25; 1x # 2x25	

## 8009 Zyklop Pocket Set 2

Compact Zyklop ratchet with bit magazine for the pocket. Magnetic direct mounting for 1/4" bits and 3/8" sockets. Rapid tool change thanks to the non-locking mounting. As the head is lockable at 0°, 15° and 90°, the tool can be used as a ratchet and as a ratchet screwdriver.

The fine toothing with 72 teeth allows for a low return angle of 5°. Wide range of applications thanks to 12 bits integrated in the handle. The robust ratchet mechanism allows for ample torque. Perfect combination of a Zyklop ratchet with a 12-piece screwdriver set.

The 75 mm long universal holder for 1/4" bits can be used as an extension. Including sockets in the commonest dimensions. One robust textile holster 9468 to be attached to the belt and docked onto the Wera 2go system.

- Compact Zyklop ratchet with integrated bit magazine
- The magnetic direct mounting simultaneously turns the 3/8" ratchet into a bit ratchet screwdriver with 1/4" bit mounting
- Freely pivoting ratchet head with 5 predefined locking positions
- Fine tooth reversible ratchet (72 teeth) for a low return angle of only 5°
- Captive and freely swivelling bit magazine for easy removal and secure storage of the bits
- Universal holder with stainless steel sleeve and strong permanent magnet, can be used as extension
- Robust textile holster to be attached to the belt and docked onto the Wera 2go system

## 8009 Zyklop Pocket Set 2



Code	EAN		
05004281001	4013288 223050		1
		<b>8009</b> 1x 3/8"x1/4"x133,0	
		<b>893/1/1</b> 1x 1/4"x75	
		<b>851/1 BTZ</b> 1x PH 1x25; 1x PH 2x25	
		<b>855/1 BTZ</b> 1x PZ 1x25; 1x PZ 2x25	
		<b>867/1 TORX® BTZ</b> 1x TX 10x25; 1x TX 15x25; 1x TX 20x25; 1x TX 25x25	
		<b>840/1 BTZ</b> 1x 3,0x25; 1x 4,0x25; 1x 5,0x25; 1x 6,0x25	
		<b>8790 HMB</b> 1x 8,0x29,0; 1x 10,0x29,0; 1x 13,0x29,0	
		<b>9468</b> 1x 155,0x65,0	
		<b>Hook and Loop Fastener Strip 70</b> 1x 50,0x70,0	

## 8009 Zyklop Pocket Imperial Set 2



## Zyklop Pocket

Comprehensive and space-saving ratchet/screwdriver combination. Compact Zyklop ratchet with bit magazine for the pocket. Magnetic direct mounting for 1/4" bits and 3/8" sockets. Rapid tool change thanks to the non-locking mounting. As the head is lockable at 0°, 15° and 90°, the tool can be used as a ratchet and as a ratchet screwdriver. The fine tooththing with 72 teeth allows for a low return angle of 5°.

Wide range of applications thanks to 12 bits integrated in the handle. The robust ratchet mechanism allows for ample torque. Perfect combination of a Zyklop ratchet with a 12-piece screwdriver set.

The 75 mm long universal holder for 1/4" bits can be used as an extension. Including sockets in the commonest dimensions. In a textile box, which can be docked onto the Wera 2go system.

- Compact Zyklop ratchet with integrated bit magazine
- The magnetic direct mounting simultaneously turns the 3/8" ratchet into a bit ratchet screwdriver with 1/4" bit mounting
- Freely pivoting ratchet head with 5 predefined locking positions
- Fine tooth reversible ratchet (72 teeth) for a low return angle of only 5°
- Captive and freely swivelling bit magazine for easy removal and secure storage of the bits

Code	EAN		
05004283001	4013288 223067		1
		<b>8009</b> 1x 3/8"x1/4"x133,0	
		<b>893/1/1</b> 1x 1/4"x75	
		<b>851/1 BTZ</b> 1x PH 1x25; 1x PH 2x25	
		<b>867/1 TORX® BTZ</b> 1x TX 10x25; 1x TX 15x25; 1x TX 20x25; 1x TX 25x25	
		<b>840/1 Z</b> 1x 1/8"x25; 1x 5/32"x25; 1x 3/16"x25; 1x 1/4"x25	
		<b>868/1 Z</b> 1x # 1x25; 1x # 2x25	
		<b>8790 HMB</b> 1x 5/16"x29,0; 1x 3/8"x29,0; 1x 1/2"x29,0	
		<b>9468</b> 1x 155,0x65,0	
		<b>Hook and Loop Fastener Strip 70</b> 1x 50,0x70,0	

### 8009 Zyklop Pocket Set 3



Code	EAN			
05004284001	227560			1
		8009	1x 3/8"x1/4"x133,0	
		8794 SB	1x 3/8"x125,0	
		893/1/1	1x 1/4"x75	
		8790 HMB	1x 6,0x29,0; 1x 7,0x29,0; 1x 8,0x29,0; 1x 9,0x29,0; 1x 10,0x29,0; 1x 11,0x29,0; 1x 12,0x29,0; 1x 13,0x29,0; 1x 14,0x29,0; 1x 15,0x29,0; 1x 16,0x30,0; 1x 17,0x30,0	
		851/1 BTZ	1x PH 1x25; 1x PH 2x25	
		855/1 BTZ	1x PZ 1x25; 1x PZ 2x25	
		867/1 TORX® BTZ	1x TX 10x25; 1x TX 15x25; 1x TX 20x25; 1x TX 25x25	
		840/1 BTZ	1x 3,0x25; 1x 4,0x25; 1x 5,0x25; 1x 6,0x25	
		Hook and Loop Fastener Strip 120	1x 50,0x120,0	

### 8009 Zyklop Pocket Set 4



Code	EAN			
05004285001	227591			1
		8009	1x 3/8"x1/4"x133,0	
		8794 SB	1x 3/8"x125,0	
		893/1/1	1x 1/4"x75	
		8790 HMB	1x 8,0x29,0; 1x 9,0x29,0; 1x 10,0x29,0; 1x 12,0x29,0; 1x 14,0x29,0; 1x 16,0x30,0; 1x 1/4"x29,0; 1x 3/16"x29,0; 1x 3/8"x29,0; 1x 7/16"x29,0; 1x 1/2"x29,0; 1x 9/16"x29,0	
		851/1 BTZ	1x PH 1x25; 1x PH 2x25	
		867/1 TORX® BTZ	1x TX 10x25; 1x TX 15x25	
		800/1 BTZ	1x 0,8x5,5x25; 1x 1,2x6,5x25	
		840/1 BTZ	1x 4,0x25; 1x 6,0x25	
		840/1 Z	1x 3/16"x25; 1x 1/4"x25	
		868/1 Z	1x # 1x25; 1x # 2x25	
		Hook and Loop Fastener Strip 120	1x 50,0x120,0	

## Koloss - this ratchet is the best!

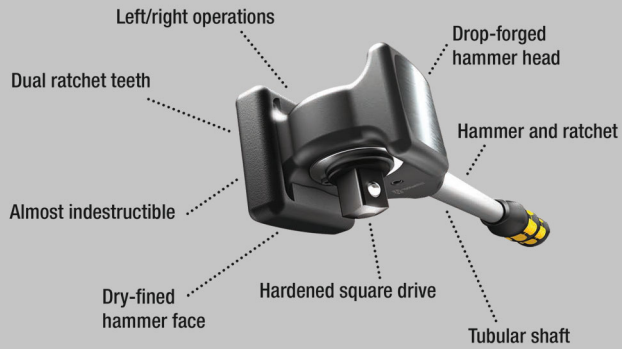

The ratchet that can also be safely and officially used as a hammer. The Koloss is a reversible, heavy-duty ratchet that can be used with a load of at least 600 Newton metres. The dual ratchet teeth and the minimum return angle of only 6° ensure rapid and precise screwdriving even in confined situations.

And the best thing: absolutely no impact on the hammer faces, however hard, can destroy the ratchet mechanism.

Multi-component Kraftform handle optimised to withstand pressure, impact and tensile loads; take-up for Koloss extension 8780 C and Koloss centring pin 8781 C at end of handle. Also included in the set: 1 pad to protect materials and surface areas, 1 Koloss extension for the transfer of even more torque, 1 unlocking pin and 1 holster – so the Koloss can always be at hand.

- For loads of at least 600 Newton metres
- Push-through square drive for right/left switchover
- Including hammer function
- Multi-component Kraftform handle optimised to withstand pressure, impact and tensile loads
- Fine-pitched ratchet mechanism, small return angle of 6°

### 8002 C Koloss All Inclusive Set with ½" drive



Code	EAN		
	4013288		
05133862001	162403		1
		<b>8002 C</b> 1x ½"x341,0	
		<b>8782 C</b> 1x 2x50,0	
		<b>8780 C</b> 1x 341,0x137	
		<b>8000 E</b> 1x 40,5	
		<b>8000 HLF</b> 1x 175,0x75,0	

### 8002 C Koloss ½" with ½" drive



Code	EAN		
	4013288		
05003692001	144607		1
		<b>8002 C</b> 1x ½"x341,0	
		<b>8782 C</b> 1x 2x50,0	
		<b>8000 HLF</b> 1x 175,0x75,0	



### 8780 C Koloss extension

Extension for the Wera Koloss out of tough, tempered chrome-molybdenum steel. Can be used as an extension with the Wera Koloss 8002 C to increase the torque to be applied. Multi-component Kraftform handle optimised to withstand pressure, impact and tensile loads. Safety instructions laser-engraved for permanent recognition.

### 8780 C Koloss extension



	EAN	⌀	⌀							
Code	4013288	mm	mm							
05003695001	144614	341,0	137							1

### 8781 C Koloss centring pin

Centring pin for the Wera Koloss. To align lugs or drill holes. Conical pin, tough, hardened chrome-molybdenum steel.

### 8781 C Koloss centring pin



	EAN	⌀	⌀							
Code	4013288	mm	mm							
05003696001	144683	50	135,0							1

### 8782 C Koloss pad set

Protective pads for the Wera Koloss. To protect materials and surfaces of workpieces. Flexible thermoplastic, elastomer material offering permanent elasticity and maximum protection.

### 8782 C Koloss pad set



	EAN	#	mm							
Code	4013288	#	mm							
05003697001	144690	2	50,0							1

### 8000 E Unlocking pin



	EAN	⌀								
Code	4013288	mm								
05136400001	194633	40,5								1

### Socket rail C (textile belt), 6 location, unloaded

- Empty socket belt for 6 sockets/bit sockets, 1/2"
- Includes a convenient snap hook
- Smooth Twist to Unlock mechanism for a secure fit and simple removal of the sockets
- Suitable for attachment to a wall, shelf, tool trolley and to the Wera 2go System

### Socket rail C (textile belt), 6 location, unloaded



Code	EAN									
	4013288									
05003892001	205797									1

**Belt C 0/6**  
1x 45,0x275,0

**Hook and Loop Fastener Strip 30**  
1x 30,0x200,0

### 9602 Magnetic socket rail, 1/2", empty

1 socket rail, empty. For up to 10 sockets and/or bit sockets with 1/2" drive.

The rail allows temporary attachment to metallic surfaces and, with its twist-to-unlock function, ensures secure locking and unlocking of the sockets.

- Rail with secure bit mounting and yet easy removal (twist-to-unlock) for temporary attachment on wall, shelf or workshop trolley
- Smooth Twist to Unlock mechanism for a secure fit and simple removal of the sockets
- Empty, for up to 10 sockets, 1/2"

### 9602 Magnetic socket rail, 1/2", empty

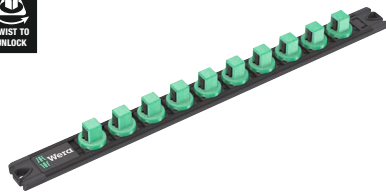
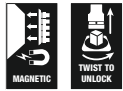

Code	EAN	mm	mm						
05136422001	223340	30,0	370,0						1

### Socket rail C Impaktor (textile belt), 9 location, unloaded



Code	EAN			
05003893001	211484			1
		<b>Belt C Impaktor 0/9</b> 1x 71,0x210,0		
		<b>Hook and Loop Fastener Strip 30</b> 1x 30,0x200,0		

### Zyklop Mini - beauty in strength

**Zyklop Mini 1**  
Thumbwheel for rapid fastening.

**Zyklop Mini 2**  
The Zyklop Mini 2 is suitable for the direct attachment of the special Wera Zyklop sockets 8790 FA. These sockets feature a very low height, ideal for confined working spaces.

**Zyklop Mini 3**  
Mini ratchet suitable for direct mounting of 1/4" sockets.



**Zyklop Mini 1 & 2 & 3**  
Fine tooth mechanism (60 teeth), small return angle of only 6° – ideal for precision work.

**Zyklop Mini 1 & 2 & 3**  
Easy switching between left/right operations.

**Zyklop Mini 1 & 2 & 3**  
Its slim design makes it ideal for all particularly confined working situations.

Wera Zyklop Mini 1: a symbiosis of strength and stylishness. Incredibly robust due to its drop-forged, full-steel design. Can withstand torque forces up to 65 Nm.

The petite sizing is particularly suited for work in confined spaces. The thumbwheel allows fast screwdriving. Comes in a set in the proven Wera Bit-Check with socket adaptor and belt clip. Simple tool removal and reinsertion is ensured, very robust and durable.

- Bit-Checks convince due to their functionality in a minimum of space
- Wera Mini ratchet for particularly fast screwdriving even in confined spaces
- Ideal for working in confined spaces
- Tough viscous bits for universal use
- In handy and robust Bit-Check

## Bit-Check 30 Zyklus Mini 1



## Bit-Check 30 Zyklus Mini 2



Code	EAN			
05073640001	144652			1
		<b>8001 A</b> 1x 1/4"x87,0		
		<b>870/1</b> 1x 1/4"x25 <sup>1)</sup>		
		<b>889/4/1 K</b> 1x 1/4"x50		
		<b>851/1 TZ PH</b> 2x PH 1x25; 3x PH 2x25; 1x PH 3x25		
		<b>855/1 TH PZ</b> 1x PZ 1x25; 3x PZ 2x25; 1x PZ 3x25		
		<b>867/1 TZ TORX®</b> 1x TX 10x25; 1x TX 15x25; 1x TX 20x25; 1x TX 25x25; 1x TX 30x25; 1x TX 40x25		
		<b>867/1 Z TORX® B0</b> 1x TX 10x25; 1x TX 15x25; 1x TX 20x25; 1x TX 25x25; 1x TX 30x25		
		<b>800/1 TZ</b> 1x 1,0x5,5x25		
		<b>840/1 Z Hex-Plus</b> 1x 3,0x25; 1x 4,0x25; 1x 5,0x25; 1x 6,0x25; 1x 8,0x25		

<sup>1)</sup>With friction ball; for manual nut spinner sockets

Code	EAN			
05346293001	145765			1
		<b>8001 A</b> 1x 1/4"x87,0		
		<b>889/4/1 K</b> 1x 1/4"x50		
		<b>870/1</b> 1x 1/4"x25 <sup>1)</sup>		
		<b>851/1 TZ PH</b> 2x PH 1x25; 3x PH 2x25; 1x PH 3x25		
		<b>867/1 TZ TORX®</b> 1x TX 10x25; 1x TX 15x25; 1x TX 20x25; 1x TX 25x25; 1x TX 30x25; 1x TX 40x25		
		<b>867/1 Z TORX® B0</b> 1x TX 10x25; 1x TX 15x25; 1x TX 20x25; 1x TX 25x25; 1x TX 30x25		
		<b>840/1 Z Hex-Plus</b> 1x 3/32"x25; 1x 1/8"x25; 1x 5/32"x25; 1x 3/16"x25; 1x 1/4"x25		
		<b>800/1 TZ</b> 1x 1,0x5,5x25		
		<b>868/1 Z</b> 1x # 1x25; 3x # 2x25; 1x # 3x25		

<sup>1)</sup>With friction ball; for manual nut spinner sockets

## Kraftform Kompakt Zyklus Mini 2

Ratchets and screws in a Kraftform Kompakt format. These drop-forged, full-steel ratchets, Zyklus Mini 1 and 2, combine filigree design with incredible robustness.

For particularly rapid screwdriving in confined working situations. Zyklus Mini 1 or Zyklus Mini 2 can be used whenever screwdriving with power tools or conventional hand tools is unfeasible for lack of space. 1 bit ratchet Zyklus Mini 1; suitable for the take-up of bits with 1/4" hexagon head drive as per DIN ISO 1173-C 6.3 and E 6.3 and Wera connecting series 1 and 4; also possible to use 1/4" sockets by attaching the Wera adaptor 870/1. 1 socket ratchet Zyklus Mini 2; suitable for the direct attachment of Wera Zyklus special sockets 8790 FA.

### Kraftform Kompakt Zyklus Mini 2



Code	EAN		
05135918001	4013288 182180		1
		<b>8001 A</b> 1x 1/4"x87,0	
		<b>8005 Zyklus Mini 2 Ratchet</b> 1x 107	
		<b>813</b> 1x 1/4"x78	
		<b>870/1</b> 1x 1/4"x25 <sup>1)</sup>	
		<b>851/1 Z PH</b> 1x PH 1x25; 1x PH 2x25	
		<b>855/1 Z PZ</b> 1x PZ 1x25; 1x PZ 2x25	
		<b>867/1 TORX®</b> 1x TX 10x25; 1x TX 15x25; 1x TX 20x25; 1x TX 25x25; 1x TX 30x25; 1x TX 40x25	
		<b>840/1 Z Hex-Plus</b> 1x 3,0x25; 1x 4,0x25; 1x 5,0x25; 1x 6,0x25	
		<b>8790 FA</b> 1x 4,0; 1x 5,0; 1x 5,5; 1x 6,0; 1x 7,0; 1x 8,0; 1x 10,0; 1x 12,0; 1x 13,0	
		<b>Hook and Loop Fastener Strip 120</b> 1x 50,0x120,0	

<sup>1)</sup>With friction ball; for manual nut spinner sockets

## Tool-Check PLUS

Combination tool consisting of a ratchet, bits, sockets and holder in a minimum of space. Ideal as a universal companion for a whole host of screwdriving applications. High quality bit holder with Kraftform Plus handle for pleasant, ergonomic working that prevents blisters and calluses. Hard gripping zones for high working speeds whereas soft zones ensure high torque transfer. Mini ratchet for rapid working when fastening jobs with a power tool or conventional hand tools are not feasible due to insufficient space. Rapid changeover from left to right direction and vice versa by using the switchover lever. Fast work possible by turning the thumbwheel (with the thumb) on the ratchet head. Simplest operation even with just one hand. Ergonomic ratchet head/lever: Kraftform geometry with perfectly shaped contact areas for the fingers.

The direct bit take-up in the ratchet head makes for a mini tool design and is ideal for low working heights. The small return angle of 6° allows for precise work. Robust drop-forged, full steel design. Torque of over 65 Nm.

The Rapidaptor bit holder with free-turning sleeve: can be used as an extension; for rapid bit change without any special tools – even the very smallest bits with just a single hand. Tough viscous bits for universal use. Sockets for both manual as well as power tool operations for almost all applications.

Take it easy Tool Finder with colour coding according to size - for simple and rapid accessing of the required tool. Featuring a good grip to allow easy pick-up even with oily hands. Ball stop groove, for hex head bolts and nuts; chrome vanadium steel, matt chrome-plated.

## Tool-Check PLUS



Code	EAN			
05056490001	4013288			1
	173003			
		<b>8001 A</b> 1x 1/4"x87,0		
		<b>813</b> 1x 1/4"x78		
		<b>889/4/1 K</b> 1x 1/4"x50		
		<b>870/1</b> 1x 1/4"x25 <sup>1)</sup>		
		<b>8790 HMA</b> 1x 5,5x23,0; 1x 6,0x23,0; 1x 7,0x23,0; 1x 8,0x23,0; 1x 10,0x23,0; 1x 12,0x23,0; 1x 13,0x23,0		
		<b>851/1 TZ PH</b> 2x PH 1x25; 3x PH 2x25; 1x PH 3x25		
		<b>855/1 TH PZ</b> 1x PZ 1x25; 3x PZ 2x25; 1x PZ 3x25		
		<b>867/1 TZ TORX®</b> 1x TX 10x25; 1x TX 15x25; 1x TX 20x25; 1x TX 25x25; 1x TX 30x25; 1x TX 40x25		
		<b>867/1 Z TORX® BO</b> 1x TX 10x25; 1x TX 15x25; 1x TX 20x25; 1x TX 25x25; 1x TX 30x25		
		<b>840/1 Z Hex-Plus</b> 1x 3,0x25; 1x 4,0x25; 1x 5,0x25; 1x 6,0x25; 1x 8,0x25		
		<b>800/1 TZ</b> 1x 1,0x5,5x25		

<sup>1)</sup> With friction ball; for manual nut spinner sockets

<sup>2)</sup> Discontinued item. New version available from 1 June 2025.

## Tool-Check PLUS Imperial



Code	EAN			
05056491001	4013288			1
	178756			
		<b>8001 A</b> 1x 1/4"x87,0		
		<b>813</b> 1x 1/4"x78		
		<b>889/4/1 K</b> 1x 1/4"x50		
		<b>870/1</b> 1x 1/4"x25 <sup>1)</sup>		
		<b>8790 HMA</b> 1x 3/16"x23,0; 1x 1/4"x23,0; 1x 5/16"x23,0; 1x 11/32"x23,0; 1x 3/8"x23,0; 1x 7/16"x23,0; 1x 1/2"x23,0		
		<b>851/1 TZ PH</b> 2x PH 1x25; 3x PH 2x25; 1x PH 3x25		
		<b>800/1 TZ</b> 1x 1,0x5,5x25		
		<b>867/1 TZ TORX®</b> 1x TX 10x25; 1x TX 15x25; 1x TX 20x25; 1x TX 25x25; 1x TX 30x25; 1x TX 40x25		
		<b>867/1 Z TORX® BO</b> 1x TX 10x25; 1x TX 15x25; 1x TX 20x25; 1x TX 25x25; 1x TX 30x25		
		<b>840/1 Z Hex-Plus</b> 1x 3/32"x25; 1x 1/8"x25; 1x 5/32"x25; 1x 3/16"x25; 1x 1/4"x25		
		<b>868/1 V</b> 1x # 1x25; 3x # 2x25; 1x # 3x25		

<sup>1)</sup> With friction ball; for manual nut spinner sockets

<sup>2)</sup> Discontinued item. New version available from 1 June 2025.

## Tool-Check 1 SB

- 1/4" bit ratchet, tough-absorbing bits, Rapidaptor holder, adaptor and 1/4" sockets
- Ideal for working in confined spaces
- Tough viscous bits for universal use
- Use of 1/4" sockets also possible with the Wera adaptor 870/1
- Take it easy tool finder: colour coding according to profile and size

### Tool-Check 1 SB



Code	EAN		
05073220001	162526		1
		8001 A 1x 1/4"x87,0	
		870/1 1x 1/4"x25 <sup>1)</sup>	
		889/4/1 K 1x 1/4"x50	
		851/1 TZ PH 2x PH 1x25; 3x PH 2x25; 1x PH 3x25	
		855/1 TH PZ 1x PZ 1x25; 3x PZ 2x25; 1x PZ 3x25	
		867/1 TZ TORX® 1x TX 10x25; 1x TX 15x25; 1x TX 20x25; 1x TX 25x25; 1x TX 30x25; 1x TX 40x25	
		867/1 Z TORX® B0 1x TX 10x25; 1x TX 15x25; 1x TX 20x25; 1x TX 25x25; 1x TX 30x25	
		800/1 TZ 1x 1,0x5,5x25	
		840/1 Z Hex-Plus 1x 3,0x25; 1x 4,0x25; 1x 5,0x25; 1x 6,0x25; 1x 8,0x25	
		8790 HMA 1x 5,5x23,0; 1x 6,0x23,0; 1x 7,0x23,0; 1x 8,0x23,0; 1x 10,0x23,0; 1x 12,0x23,0; 1x 13,0x23,0	

<sup>1)</sup> With friction ball; for manual nut spinner sockets

<sup>2)</sup> Discontinued item. New version available from 1 June 2025.

## Tool-Check Automotive 1



Code	EAN		
05200995001	165343		1
		8001 A 1x 1/4"x87,0	
		870/1 1x 1/4"x25 <sup>1)</sup>	
		889/4/1 K 1x 1/4"x50	
		851/1 TZ PH 1x PH 1x25; 1x PH 2x25; 1x PH 3x25	
		867/1 TZ TORX® 1x TX 10x25; 1x TX 15x25; 1x TX 20x25; 1x TX 25x25; 1x TX 30x25; 1x TX 40x25	
		867/1 Z TORX® B0 1x TX 10x25; 1x TX 15x25; 1x TX 20x25; 1x TX 25x25; 1x TX 30x25	
		800/1 TZ 1x 1,0x5,5x25	
		840/1 Z Hex-Plus 1x 3,0x25; 1x 4,0x25; 1x 5,0x25; 1x 6,0x25; 1x 8,0x25	
		860/1 XZN 1x M 4x25; 1x M 5x25; 1x M 6x25; 1x M 8x25	
		873/1 Five Lobe 1x 20x25; 1x 25x25; 1x 27x25; 1x 30x25	
		8790 HMA 1x 5,5x23,0; 1x 6,0x23,0; 1x 7,0x23,0; 1x 8,0x23,0; 1x 10,0x23,0; 1x 12,0x23,0; 1x 13,0x23,0	

<sup>1)</sup> With friction ball; for manual nut spinner sockets

<sup>2)</sup> Discontinued item. New version available from 1 June 2025.

### Bit-Check 10 Zyklop Mini BiTorsion 1

Many tools in a minimum of space. The sorting according to drive and size allows rapid accessing of the bits.

The Wera Mini ratchet: drop-forged, full-steel design. Fine-pitched mechanism with 60 teeth that allows a small return angle of only 6° for precise work. Simple left/right switchover. Ergonomically-designed ratchet head and lever.

- 1/4" Mini ratchet and tough viscous bits

#### Bit-Check 10 Zyklop Mini BiTorsion 1



Code	EAN		
05057418001	4013288 195951		1
		<b>8001 A</b> 1x 1/4"x87,0	
		<b>851/1 BTZ PH</b> 1x PH 1x25; 1x PH 2x25	
		<b>855/1 BTZ PZ</b> 1x PZ 1x25; 1x PZ 2x25	
		<b>867/1 TORX® BTZ</b> 1x TX 15x25; 1x TX 20x25; 1x TX 25x25	
		<b>840/1 BTZ Hex-Plus</b> 1x 4,0x25; 1x 5,0x25	

### Bit-Check 10 Zyklop Mini 1

Many tools in a minimum of space. The sorting according to drive and size allows rapid accessing of the bits. The Wera Mini ratchet: drop-forged, full-steel design.

Fine-pitched mechanism with 60 teeth that allows a small return angle of only 6° for precise work. Simple left/right switchover. Ergonomically-designed ratchet head and lever.

- Tough viscous bits for universal use

#### Bit-Check 10 Zyklop Mini 1



Code	EAN		
05073645001	4013288 168115		1
		<b>8001 A</b> 1x 1/4"x87,0	
		<b>851/1 Z PH</b> 1x PH 1x25; 1x PH 2x25	
		<b>855/1 Z PZ</b> 1x PZ 1x25; 1x PZ 2x25	
		<b>867/1 TORX®</b> 1x TX 15x25; 1x TX 20x25; 1x TX 25x25	
		<b>840/1 Z Hex-Plus</b> 1x 4,0x25; 1x 5,0x25	

## Bicycle Set 1

Bicycle repair shops and passionate cyclists love screwdriving on a bicycle. With their Bicycle Set 1, the screwdriving tool specialist Wera offers an assortment of tools that is very mobile thanks to its compact and design-oriented textile folding bag, and offers solutions for the most common screwdriving situations when working with bicycles.

The sturdy bag contains the bit ratchet Zyklop Mini 1 and 10 bits with all the benefits of Wera-Bit technology, specially adapted to the most common screw connections on a bicycle.

With the glass fibre reinforced plastic tyre levers, the tyres can be safely levered off the rim without damaging the rim.

- Compact 14-piece screwdriving tool set for bicycle applications, also for mobile use
- Practical range for DIY assembly work and repairs
- Suitable tools for the most common bolt profiles on road bikes, mountain bikes and e-bikes
- Robust, surface-friendly, compact textile folding bag
- Set including Mini bit ratchet, extension and two tyre levers with additional functions

## Bicycle Set 1



Code	EAN		
05004170001	4013288 207623		1
		<b>8001 A</b> 1x 1/4"x87,0	
		<b>3899/4/1</b> 1x 1/4"x100	
		<b>851/1 Z PH</b> 1x PH 2x25	
		<b>867/1 TORX®</b> 1x TX 10x25; 1x TX 25x25	
		<b>840/1 Z Hex-Plus</b> 1x 2,0x25; 1x 2,5x25; 1x 3,0x25; 1x 4,0x25; 1x 5,0x25; 1x 6,0x25; 1x 8,0x25	
		<b>9502</b> 1x 105.0	
		<b>9503</b> 1x 105.0	
		<b>Hook and Loop Fastener Strip 70</b> 1x 50,0x70,0	



## Bicycle Set 3

Juego de herramientas para la bicicleta, con carraca, puntas, vasos así como un mango porta-puntas – todo en un espacio sumamente reducido. Es un acompañante universal perfecto que ofrece toda una variedad de aplicaciones para trabajos en uniones atornilladas de bicicletas. El mango porta-puntas es de altísima calidad, el mango es de tipo “Kraftform Plus” que permite un trabajo agradable y sumamente ergonómico ya que evita la formación de ampollas y callosidades en las manos. Las zonas de agarre duras sirven para las altas velocidades de trabajo mientras que las zonas blandas proporcionan una alta transmisión del par de giro. La carraca de puntas permite un trabajo muy rápido en aquellos casos en los cuales no es posible atornillar a máquina, o con ayuda de otros útiles corrientes, por ejemplo, por falta de espacio. La conmutación del sentido de giro de izquierda a derecha y al revés, se realiza de forma muy rápida por medio de la palanca de conmutación. El giro rápido manual se realiza (con el pulgar) con el borde estriado en la cabeza de la carraca. El manejo es supersencillo, incluso con una sola mano. La cabeza de la carraca y la palanca que lleva la carraca son ergonómicas: están fabricadas con base en la geometría tipo “Kraftform” que ofrece unas superficies de apoyo perfectas para los dedos del usuario.

Por el hecho de que la toma de las puntas se realiza directamente en la cabeza de la carraca fue posible desarrollar unas herramientas sumamente compactas que son ideales para espacios de trabajo muy reducidos. El ángulo de recuperación es muy pequeño: tan solo mide 6° lo que permite un trabajo sumamente preciso. La carraca está elaborada completamente en acero forjado en estampa y es sumamente robusta. Los pares de giro superan los 65 Nm. El porta-puntas es de tipo Rapidaptor con manguito de giro rápido: se puede utilizar como prolongación y permite un cambio de las puntas ultrarrápido sin tener que utilizar herramienta adicional, incluso en el caso de las puntas de tamaño mínimo, y todo con una sola mano. Las puntas son duras y resistentes y sirven para la utilización universal. Los vasos son adecuados para trabajos manuales y mecánicos, y se prestan para casi todas las aplicaciones posibles. El juego lleva el sistema de búsqueda de herramienta “Take it easy” con marcas a color según el tamaño, para encontrar la herramienta que se necesita de forma más sencilla y rápida. El agarre es excelente y permite trabajar sin problema alguno incluso con las manos llenas de aceite. Con una ranura de retención de bola. Para tornillos y tuercas de hexágono exterior. De cromo-vanadio cromado en tono mate.

- Juego compacto de herramientas de atornillado de 41 piezas para aplicaciones en bicicletas, también durante los desplazamientos
- Un juego práctico para la realización autónoma de trabajos de montaje y reparaciones
- Las herramientas llevan los perfiles de tornillos más usuales en bicicletas, bicis de montaña y bicicletas eléctricas
- Con el sistema de búsqueda de herramienta “Take it easy”: con marcas a color según el tamaño correspondiente
- El estuche es robusto, compacto, de material textil, pesa muy poco y cuida las superficies en las que se deposita
- Incluye dos llaves de neumáticos con funciones adicionales

## Bicycle Set 3



Code	EAN		
05004172001	4013288 211248		1
		8001 A 1x 1/4"x87,0	
		813 1x 1/4"x78	
		889/4/1 K 1x 1/4"x50	
		870/1 1x 1/4"x25 <sup>1)</sup>	
		8790 HMA 1x 5,5x23,0; 1x 6,0x23,0; 1x 7,0x23,0; 1x 8,0x23,0; 1x 10,0x23,0; 1x 13,0x23,0; 1x 15,0x23,0	
		851/1 TZ PH 1x PH 1x25; 2x PH 2x25; 1x PH 3x25	
		867/1 TZ TORX® 1x TX 10x25; 1x TX 15x25; 2x TX 20x25; 2x TX 25x25; 1x TX 27x25; 1x TX 30x25; 1x TX 40x25	
		800/1 TZ 1x 0,5x4,0x25; 1x 0,6x4,5x25; 1x 1,0x5,5x25	
		840/1 Z Hex-Plus 1x 2,0x25; 1x 2,5x25; 1x 3,0x25; 1x 4,0x25; 1x 5,0x25; 1x 6,0x25; 1x 8,0x25	
		842/1 Z 1x 2,5x25; 1x 3,0x25; 1x 4,0x25; 1x 5,0x25; 1x 6,0x25	
		9502 1x 105.0	
		9503 1x 105.0	
		Cinta autoadhesiva 120 1x 50,0x120,0	

<sup>1)</sup> Con bola; para llaves de vaso de uso manual

<sup>2)</sup> Artículos de caducidad. Los artículos sucesores estarán disponibles a partir del 01.06.2025

## Bicycle Set 3 A

Juego de herramientas para la bicicleta con carraca, puntas, vasos y un porta-puntas en un espacio muy compacto. Se trata de un acompañante perfecto y universal que incluye toda una variedad de aplicaciones para trabajos en uniones atornilladas. Un elemento muy especial: el juego incluye dos bolsos - el bolso para todo el juego completo, y un estuche más pequeño de material suave para llevar herramienta de forma segura durante el viaje en bici y guardarla dentro de la camiseta de ciclista. El estuche de material suave además dispone de presillas para alojar cartuchos de CO2 (los cartuchos no están incluidos en el juego).

El juego lleva herramienta práctica para la cadena de la bici (tronchacademas y soportacademas) que sirven para reparar la cadena de las bicicletas.

El porta-puntas de alta calidad con el mango Kraffform Plus permite un trabajo agradable y ergonómico. La carraca de puntas sirve para un trabajo rápido en el caso de que, a causa de falta de espacio, no sea posible utilizar la máquina de atornillar, o herramienta manual normal, para realizar los trabajos en uniones atornilladas. Con ayuda de la palanca de reenvío es posible conmutar de forma rápida entre la marcha hacia la izquierda y la marcha hacia la derecha y viceversa. Por medio de la rueda moleteada en la cabeza de la carraca se puede realizar un movimiento de giro rápido (con el dedo pulgar). Incluso con una sola mano el manejo es extremadamente fácil. La cabeza y la palanca de la carraca son ergonómicas ya que las superficies de apoyo para los dedos disponen de la geometría perfecta tipo Kraffform. Gracias a la toma directa de la punta en la cabeza de la carraca se consigue un tamaño reducido de la herramienta y así se tienen unas alturas de trabajo mínimas. El ángulo de retorno es de tan solo 6° lo cual permite un trabajo muy preciso. La herramienta ha sido construida de forma robusta de acero macizo forjado en estampa. Los pares de giro son de más de 65 Nm. El porta-puntas Rapidaptor dispone de un casquillo de giro rápido: se puede utilizar como prolongación, para un cambio superrápido de las puntas sin herramientas auxiliares, incluso de las puntas más pequeñas y con una sola mano.

Vasos Zyklop con marcas a color y sellos según el tamaño – para encontrar el vaso preciso de forma fácil y rápida. En el extremo posterior, el moleteado sirve para poder agarrar los vasos mejor, incluso con las manos llenas de aceite. Con ranura de captación de bolas. Para tornillos y tuercas de hexágono exterior. Fabricados de cromo-vanadio de cromo mate.

Con ayuda de los desmontaneumáticos de plástico reforzados con fibra de vidrio, es posible levantar los neumáticos de la llanta haciendo palanca, de una forma segura y sin dañar la llanta. Un desmontaneumático dispone de un extractor de válvulas, y el otro con toma de puntas de 1/4".

- Juego compacto de herramientas de atornillado de 41 piezas para aplicaciones en bicicletas, también durante los desplazamientos
- Un juego práctico para la realización autónoma de trabajos de montaje y reparaciones
- Las herramientas llevan los perfiles de tornillos más usuales en bicicletas, bicis de montaña y bicicletas eléctricas
- Con el sistema de búsqueda de herramienta „Take it easy”: con marcas de colores según el tamaño correspondiente
- El estuche es robusto, compacto, de material textil, pesa muy poco y cuida las superficies en las que se deposita
- Incluye dos llaves de neumáticos con funciones adicionales

## Bicycle Set 3 A



Code	EAN		
05004183001	4013288 227607		1
		8001 A 1x 1/4"x87,0	
		813 1x 1/4"x78	
		3899/4/1 1x 1/4"x100	
		889/4/1 K 1x 1/4"x50	
		870/1 1x 1/4"x25 <sup>1)</sup>	
		8790 HMA 1x 5,5x23,0; 1x 6,0x23,0; 1x 8,0x23,0; 1x 9,0x23,0; 1x 10,0x23,0; 1x 13,0x23,0; 1x 15,0x23,0	
		851/1 TZ 1x PH 1x25; 1x PH 2x25	
		867/1 TZ TORX® 1x TX 10x25; 1x TX 15x25; 1x TX 20x25; 1x TX 25x25; 1x TX 27x25; 1x TX 30x25	
		800/1 TZ 1x 0,5x4,0x25; 1x 0,6x4,5x25	
		840/1 Z 1x 2,0x25; 1x 2,5x25; 1x 3,0x25; 1x 4,0x25; 1x 5,0x25; 1x 6,0x25; 1x 8,0x25	
		842/1 Z 1x 2,5x25; 1x 3,0x25; 1x 4,0x25; 1x 5,0x25; 1x 6,0x25	
		9502 1x 105,0	
		9503 1x 105,0	
		9513 Remache de cadena	
		9512 Gancho de fijación de la cadena	
		9481 1x 203,0x85,0	
		9480 1x 90,0x135,0	
		Cinta autoadhesiva 120 1x 50,0x120,0	

<sup>1)</sup> Con bola; para llaves de vaso de uso manual

<sup>2)</sup> Artículos de caducidad. Los artículos sucesores estarán disponibles a partir del 01.06.2025

## Bicycle Set 9

A lot of bicycle tools in a small space. The sorting of the 9 stainless steel bits by profile and size allows quick access to the right tool. With one Wera Zyklop Mini 1 bit ratchet in a drop-forged solid steel design.





The fine toothing mechanism with 60 teeth allows a small return angle of 6° for precise working. The knurl allows fast screwdriving in cramped situations, when there is no space for ratcheting. Easy left/right switching.

Ergonomically shaped ratchet head and lever. With Take it easy tool finder with colour coding by size - to help you find the required tool quickly and easily.

- 10-piece Zyklop Mini set
- Mini ratchet suitable for direct mounting of 1/4" nuts
- Drop-forged full steel design for torques exceeding 65 Nm
- Fine-pitched ratchet mechanism and small return angle of 6°
- Stainless Steel Bits

## Bicycle Set 9



Code	EAN		
05004177001	4013288 220646		1
		 <b>8001 A</b> 1x 1/4"x87,0	
		 <b>3851/1 TS PH</b> 1x PH 2x25	
		 <b>3867/1 TS TORX®</b> 1x TX 10x25; 1x TX 25x25	
		 <b>3840/1 TS</b> 1x 2,0x25; 1x 2,5x25; 1x 3,0x25; 1x 4,0x25; 1x 5,0x25; 1x 6,0x25	

### 8001 A Zyklop Mini 1 Bit Ratchet 1/4" SB with 1/4" drive

The Wera Mini ratchet. Simple operation, even with just one hand, in confined working spaces. Drop-forged, full-steel design and fine-pitched mechanism with 60 teeth that allows a small return angle of 6° for precise working.

The thumbwheel allows rapid fastening in confined situations when there is no space for ratcheting.

Easy left/right switchover. Ergonomically designed ratchet head and lever. Suitable for 1/4" bit and socket take-up.

- Suitable for direct take-up of bits with 1/4" hex head drive
- Drop-forged, full-steel design
- Torque of over 65 Nm
- Fine-pitched ratchet mechanism and small return angle of 6°
- Ideal for working in confined spaces

### 8001 A Zyklop Mini 1 Bit Ratchet 1/4" SB with 1/4" drive



Code	EAN				
05073230001	144638				1
		● 8001 A	1x 1/4"x87,0		
		○ 870/1	1x 1/4"x25 <sup>1)</sup>		

<sup>1)</sup>With friction ball; for manual nut spinner sockets

### 8005 Zyklop Mini 2 Ratchet

Zyklop Mini 2 for the direct take-up of special Wera Zyklop sockets. Combines filigree design with incredible robustness. For particularly rapid screwdriving even in confined working spaces. The Zyklop Mini 2 is the preferred choice whenever fastening with a power tool or conventional hand tool is impossible due to a lack of space.

- Direct attachment of special Zyklop sockets
- Small return angle of 6° for precise working
- Simple left/right switchover
- Ideal for confined working situations

### 8005 Zyklop Mini 2 Ratchet



Code	EAN	⌀								
05003660001	179616	107								1

### 8008 A Zyklop Mini 3 Ratchet with 1/4" drive

The Wera Zyklop Mini 3 ratchet for 1/4" sockets. Simplest operation even with just one hand in confined screwdriving challenges. Drop-forged full steel design.

Fine tooth mechanism with 60 teeth allows a small return angle of 6° for precise work.

The knurled wheel allows fast screwdriving in tight spaces when there is no room for ratcheting. Simple left/right switching. Ergonomically shaped ratchet head and lever.

- Mini ratchet suitable for direct mounting of 1/4" nuts
- Drop-forged full steel design for torques exceeding 65 Nm
- Fine-pitched ratchet mechanism and small return angle of 6°
- Simple left/right switchover
- Ideal for working in confined spaces

### 8008 A Zyklop Mini 3 Ratchet with 1/4" drive



	EAN							
Code	4013288		mm					
05003793001	211699	1/4"	87,0					1

### 8790 FA Zyklop socket with 1/4" and Hexagon 11 drive

Zyklop socket with 1/4" and hex drive for manual jobs with a 1/4" ratchet.

### 8790 FA Zyklop socket with 1/4" and Hexagon 11 drive



	EAN						
Code	4013288	mm	mm	mm	mm	mm	
05003665001	179623	4,0	9,5	6,4	11,8	18,0	1
05003666001	179630	4,5	9,5	7,0	11,8	18,0	1
05003667001	179647	5,0	9,5	7,6	11,8	18,0	1
05003668001	179654	5,5	9,5	8,2	11,8	18,0	1
05003669001	179661	6,0	9,5	9,2	11,8	18,0	1
05003670001	183408	7,0	9,5	10,4	11,8	18,0	1
05003675001	179678	8,0	9,5	11,5	11,8	18,0	1
05003690001	179685	10,0	9,5	13,8	11,8	18,0	1
05003684001	183415	12,0	9,5	16,8	11,8	18,0	1
05003685001	179692	13,0	9,5	17,8	11,8	18,0	1





# Joker Wrenches & Spanners

## Joker - Can.Do.Everything.Better.



High quality, metric, combination ratchet wrench by Wera. Everything that a wrench has to be able to do. And a whole lot more. Faster, better, stylish. Yes, a real Joker. The new generation of combination ratchet wrenches.

Suitable for hexagon socket screws, bolts or nuts. Comes with holding function, thanks to the metal plate in the jaw, which reduces the risk of dropping nuts and bolts. The replaceable metal plate in the jaw secures nuts and bolts with its extra hard teeth and reduces the danger of slipping.

The integrated limit stop prevents any slipping around the bolt head and allows higher torque to be applied. The double-hex geometry makes for a positive connection with nuts or bolts and reduces the risk of slipping. A return angle of only 30° at the open end prevents any time consuming flipping of the wrench. The ratchet mechanism at the ring end, with an exceptional, fine-tooth mechanism – 80 teeth in all – enables flexibility even in very confined working spaces.

The specially forged geometry ensures high torque transfer and strength. The ratchet is manufactured out of high performance chrome molybdenum steel with nickel-chrome coating for high corrosion protection. Take it easy Tool Finder with colour coding according to sizes.

- Practical holding function thanks to the metal plate in the jaw
- Limit stop prevents any slipping
- The double-hex geometry reduces the risk of slipping
- Return angle of only 30°
- Take it easy tool finder with colour coding according to sizes

## 6000 Joker Ratcheting combination wrenches



	EAN							
Code	4013288		mm	mm	mm	mm	mm	
05073268001	167309		8	144	20	5,5	18	3
05073270001	164360		10	159	22	5,5	21	3
05073271001	167316		11	165	25	6,3	22	3
05073272001	167323		12	170,7	26,3	6,6	25	3
05073273001	164377		13	177	27,3	7	25	3
05073274001	167330		14	188	29,3	7,5	28	3
05073275001	167347		15	200	32,3	7,8	28,5	3
05073276001	167392		16	212	35	8,2	32,7	3
05073277001	164384		17	224	37,2	8,5	32,7	3
05073278001	167408		18	235	39	9	33,8	3
05073279001	164391		19	246	42	9,5	34,8	3

## 6000 Joker Ratcheting combination wrenches, Imperial



	EAN							
Code	4013288			mm	mm	mm	mm	
05073280001	167354		5/16"	144	20	5,5	18	3
05073281001	167361		3/8"	159	22	5,5	21	3
05073282001	167378		7/16"	165	25	6,3	22	3
05073283001	167385		1/2"	177	27,3	7	25	3
05073284001	167415		9/16"	188	29,3	7,5	28	3
05073285001	167422		5/8"	212	35	8,2	32,7	3
05073286001	167439		11/16"	235	39	9	33,8	3
05073287001	167446		3/4"	246	42	9,5	34,8	3



### 9630 Magnetic rail 6000 Joker 1 Ratcheting combination wrenches set

- 11-piece set
- With its strong magnet, the rail holds securely to metal surfaces. It can also be bolted to the wall
- The clips hold the tools perfectly

### 9630 Magnetic rail 6000 Joker 1 Ratcheting combination wrenches set



Code	EAN		
05020014001	228949		1
		<b>6000 Joker</b> 1x 8x144; 1x 10x159; 1x 11x165; 1x 12x170,7; 1x 13x177; 1x 14x188; 1x 15x200; 1x 16x212; 1x 17x224; 1x 18x235; 1x 19x246	
		<b>9610</b> 1x 30,0x370,0	

### 9631 Magnetic rail 6000 Joker 2 Ratcheting combination wrenches set

- 5-piece set

### 9631 Magnetic rail 6000 Joker 2 Ratcheting combination wrenches set

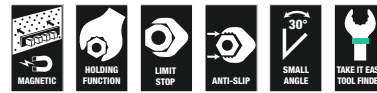

Code	EAN		
05020015001	229847		1
		<b>6000 Joker</b> 1x 8x144; 1x 10x159; 1x 13x177; 1x 17x224; 1x 19x246	
		<b>9610</b> 1x 30,0x370,0	

### 9632 Magnetic rail 6000 Joker Imperial 1 Ratcheting combination wrenches set

- 8-piece set

### 9632 Magnetic rail 6000 Joker Imperial 1 Ratcheting combination wrenches set



Code	EAN		
05020016001	229861		1
		<b>6000 Joker Imperial</b> 1x 5/16"x144; 1x 3/8"x159; 1x 7/16"x165; 1x 1/2"x177; 1x 9/16"x188; 1x 5/8"x212; 1x 11/16"x235; 1x 3/4"x246	
		<b>9610</b> 1x 30,0x370,0	

### 6000 Joker 11 Set 1 of ratcheting combination wrenches

- In robust pouch

#### 6000 Joker 11 Set 1 of ratcheting combination wrenches



<b>Code</b>	<b>EAN</b>		
05020013001	4013288 167521		1
<b>6000 Joker</b> 1x 8x144; 1x 10x159; 1x 11x165; 1x 12x170,7; 1x 13x177; 1x 14x188; 1x 15x200; 1x 16x212; 1x 17x224; 1x 18x235; 1x 19x246			

### 6000 Joker 8 Imperial Set 1 Set of ratcheting combination wrenches, Imperial

- In robust pouch

#### 6000 Joker 8 Imperial Set 1 Set of ratcheting combination wrenches, Imperial

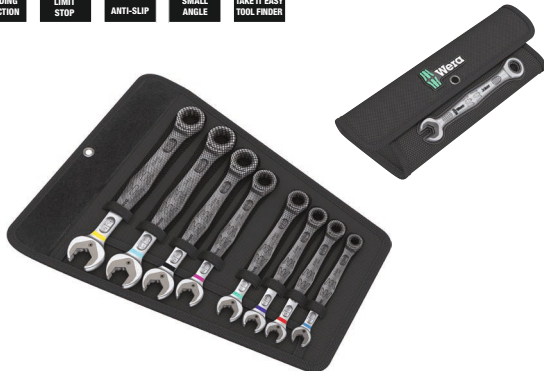

<b>Code</b>	<b>EAN</b>		
05020012001	4013288 167514		1
<b>6000 Joker Imperial</b> 1x 5/16"x144; 1x 3/8"x159; 1x 7/16"x165; 1x 1/2"x177; 1x 9/16"x188; 1x 5/8"x212; 1x 11/16"x235; 1x 3/4"x246			

### 6000/6002 Joker 6 Set 1 Set of ratcheting combination / double open-ended wrenches

- The Joker double open-ended wrench is ideally suited for locking down nuts and bolts.
- In robust pouch

#### 6000/6002 Joker 6 Set 1 Set of ratcheting combination / double open-ended wrenches



<b>Code</b>	<b>EAN</b>		
05020022001	4013288 173034		1
<b>6000 Joker</b> 1x 10x159; 1x 13x177; 1x 17x224; 1x 19x246 <b>6002 Joker Double</b> 1x 10x13x167; 1x 17x19x235			

### 6000 Joker 4 Set 1 Set of ratcheting combination wrenches

- In robust pouch

#### 6000 Joker 4 Set 1 Set of ratcheting combination wrenches



<b>Code</b>	<b>EAN</b>		
05073290001	4013288 164407		1
<b>6000 Joker</b> 1x 10x159; 1x 13x177; 1x 17x224; 1x 19x246			

## 6000 Joker 4 Imperial Set 1 Set of ratcheting combination wrenches, Imperial

- In robust pouch

### 6000 Joker 4 Imperial Set 1 Set of ratcheting combination wrenches, Imperial



Code	EAN		
05073295001	167460		1
<b>6000 Joker Imperial</b>			
1x 7/16"x165; 1x 1/2"x177; 1x 9/16"x188; 1x 3/4"x246			
<b>Hook and Loop Fastener Strip 120</b>			
1x 50,0x120,0			

## 6001 Joker Switch

Joker ratcheting combination wrenches with angled ratchet head and switch lever. The metal plate in the jaw provides for the holding function which reduces the risk of losing nuts and bolts.

The integrated limit stop can prevent any slipping from the bolt head downwards and enables higher torque to be applied.

The exchangeable metal plate in the jaw securely holds nuts and bolts with its extra hard teeth and reduces the risk of slipping.

The double-hex geometry delivers a very positive connection with nuts or bolts and again provides for a lower risk of any slipping. The low return angle of only 30° at the jaw end avoids any time-consuming flipping of the wrench when fastening.

The reversible ratchet mechanism at the ring end with its fine toothing (80 teeth) ensures great flexibility even in confined spaces. Audibly precise ratchet mechanism.

Additionally, the robust two-piece locking element provides for an extreme stability. Comes with a 15° angled ratchet end for secure work even at high torque. The special forged geometry allows for high torque transfer and high flexural rigidity. Manufactured out of high-performance chrome-molybdenum steel with a nickel-chromium coating for high corrosion protection.

With Take it easy tool finder: colour coding according to size.

- Practical holding function thanks to the metal plate in the jaw
- Limit stop prevents any slipping
- Very fine toothing and robust locking element
- Ratchet end angled by 15°
- Take it easy tool finder with colour coding according to sizes

## 6001 Joker Switch Ratcheting combination wrenches, with switch lever



Code	EAN		mm	mm	mm	mm	mm	
05020064001	184696		8	144	20,3	5,5	18	3
05020065001	183903		10	159	23	5,5	21,5	3
05020066001	183910		11	165	24,3	6,3	22	3
05020067001	183927		12	171	26,3	6,6	25	3
05020068001	184702		13	179	27,3	7	26	3
05020069001	184719		14	187	30	7,5	28	3
05020070001	184726		15	199	32	7,8	28,8	3
05020071001	184733		16	213	35	8,2	31,7	3
05020072001	184740		17	225	37	8,5	33	3
05020073001	184757		18	234	39,5	9	34	3
05020074001	184764		19	246	42	9,5	34,7	3

## 6001 Joker Switch Ratcheting combination wrenches, with switch lever, imperial



Code	EAN			mm	mm	mm	mm	
05020075001	184788		5/16"	144	20,3	5,5	18	3
05020076001	184795		3/8"	159	23	5,5	21,5	3
05020077001	184801		7/16"	165	24,3	6,3	22	3
05020078001	184818		1/2"	171	26,3	6,6	25	3
05020079001	184825		9/16"	187	30	7,5	28	3
05020080001	184832		5/8"	213	35	8,2	31,7	3
05020081001	184849		11/16"	234	39,5	9	34	3
05020082001	184771		3/4"	246	42	9,5	34,7	3

### 6001 Joker Switch 11 Set 1 Set of ratcheting combination wrenches

- Compact textile box with high robustness, low weight and volume

#### 6001 Joker Switch 11 Set 1 Set of ratcheting combination wrenches



Code	EAN		
05020091001	4013288 184160		1
		<b>6001 Joker Switch</b> 1x 8x144; 1x 10x159; 1x 11x165; 1x 12x171; 1x 13x179; 1x 14x187; 1x 15x199; 1x 16x213; 1x 17x225; 1x 18x234; 1x 19x246	
		<b>Hook and Loop Fastener Strip 240</b> 1x 50,0x240,0	

### 6001 Joker Switch 8 Imperial Set 1 Set of ratcheting combination wrenches, Imperial

- Compact textile box with high robustness, low weight and volume

#### 6001 Joker Switch 8 Imperial Set 1 Set of ratcheting combination wrenches, Imperial



Code	EAN		
05020093001	4013288 184153		1
		<b>6001 Joker Switch Imperial</b> 1x 9/16"x144; 1x 3/8"x159; 1x 7/16"x165; 1x 1/2"x171; 1x 9/16"x187; 1x 5/8"x213; 1x 11/16"x234; 1x 3/4"x246	
		<b>Hook and Loop Fastener Strip 240</b> 1x 50,0x240,0	

### 6001 Joker Switch 4 Set 1 Set of ratcheting combination wrenches

- In robust pouch

#### 6001 Joker Switch 4 Set 1 Set of ratcheting combination wrenches



Code	EAN		
05020090001	4013288 184139		1
		<b>6001 Joker Switch</b> 1x 10x159; 1x 13x179; 1x 17x225; 1x 19x246	
		<b>Hook and Loop Fastener Strip 120</b> 1x 50,0x120,0	

### 6001 Joker Switch 4 Imperial Set 1 Set of ratcheting combination wrenches, Imperial

- In robust pouch

#### 6001 Joker Switch 4 Imperial Set 1 Set of ratcheting combination wrenches, Imperial



Code	EAN		
05020092001	4013288 184146		1
		<b>6001 Joker Switch Imperial</b> 1x 7/16"x165; 1x 1/2"x171; 1x 9/16"x187; 1x 3/4"x246	
		<b>Hook and Loop Fastener Strip 120</b> 1x 50,0x120,0	

## 6002 Joker Double open-ended wrenches

- Practical holding function thanks to the metal plate in the jaw
- Limit stop prevents any slipping
- The double-hex geometry reduces the risk of slipping
- Return angle of only 30°
- Take it easy tool finder with colour coding according to sizes

### 6002 Joker Double open-ended wrenches



Code	EAN		mm	mm	mm	mm	mm	mm	
05020259001	219015		8	20	10	23	5,5	3	
05003760001	173010		10	23	13	27	5,5	3	
05003765001	173027		17	37	19	42	8,5	3	
05020260001	212764		20	48	22	51	10	3	
05020261001	212771		22	48	24	51	10	3	
05020262001	212788		24	51	27	60	11	3	
05020263001	212795		27	63	32	66	12	3	
05020264001	212801		30	63	32	66	12	3	

## 6003 Joker ring spanner

As the installation space becomes increasingly tight during screwdriving, it remains necessary that tools enable users to work successfully.

Narrow spaces require additional placement points of the tool. Can spanners be modified so that the placement possibilities of the tool increase?

The combination of the 7.5° pivoted mouth and the double hex-agon geometry doubles the placement points. A repeated 180° turn of the wrench around the longitudinal axis during screwdriving provides four placement possibilities, and bolts or screw heads can be "taken" every 15°.

The Joker 6003 with its smart mouth geometry significantly expands the range of uses in confined spaces. The Joker 6003 will automatically find the respective placement point after every turn.

The slim yet robust ring side is angled by 15° to the tool axis. The high-quality surface treatment achieves a high and long-lasting corrosion protection. With Take it easy tool finder: colour coding by size.

- Especially suitable for tight spaces
- The special mouth geometry expands the placement possibilities of the tool
- The low return angle in the mouth "takes" the screw every 15°
- Slim ring side angled by 15°
- Take it easy tool finder with colour coding according to sizes

## 6003 Joker ring spanner



Code	EAN		mm	mm	mm	mm	mm	
05020190001	219039		5,5	105	16	4	10	3
05020198001	218780		6	105	16	4	10	3
05020199001	218773		7	110	17,7	4,2	11,5	3
05020200001	212528		8	115	19	4,5	12,5	3
05020219001	220097		9	120	21	4,8	13,5	3
05020201001	212542		10	125	22	5	15	3
05020202001	212559		11	135	24,5	5	17	3
05020203001	212566		12	148	26	5,5	18	3
05020204001	212696		13	160	27	6	19	3
05020205001	212702		14	167	29	6	20	3
05020206001	212719		15	174	32	6	22	3
05020207001	212726		16	182	35	6,5	23	3
05020208001	212733		17	190	38	6,5	24,5	3
05020209001	212740		18	210	39	7,5	26	3
05020210001	212757		19	230	42	7,5	27,5	3
05020500001	218797		20	230	45	7,5	29	3
05020501001	218803		21	260	47	7,5	30	3
05020502001	218841		22	260	49	7,5	31,5	3
05020503001	218858		24	280	53	8	36	3
05020504001	218865		27	300	60	8,5	40	3
05020505001	218872		30	330	66	9	43	3
05020506001	218889		32	360	70	9,5	45,5	3
05020507001	218896		36	460	80	10	50,5	3

### 6003 Joker ring spanner, imperial



Code	EAN		mm	mm	mm	mm		
05020220001	219046		1/4"	105	16	4	10	3
05020211001	212979		5/16"	115	19	4,5	12,5	3
05020212001	212986		3/8"	125	22	5	15	3
05020213001	212993		7/16"	135	24,5	5	17	3
05020214001	213006		1/2"	160	26	6	19	3
05020215001	213013		9/16"	167	29	6	20	3
05020216001	213020		5/8"	182	35	6,5	23	3
05020217001	213037		11/16"	210	40	7,5	26	3
05020218001	213044		3/4"	230	42	7,5	27,5	3

### 6003 Joker Pedal ring spanner

The extra thin pedal wrench 6003 Joker Pedal is ideal for narrow installation spaces.

- Especially suitable for tight spaces
- The special mouth geometry expands the placement possibilities of the tool
- The low return angle in the mouth “takes” the screw every 15°
- Slim ring side angled by 15°
- Joker 6003 pedal size 15 with flat mouth to mount and dismount pedals
- With Take it easy tool finder: colour coding by size

### 6003 Joker Pedal ring spanner



	EAN								
Code	4013288	mm	mm	mm	mm	mm	mm		
05020221001	220677	15	174	32	4,5	22	1		

### 6003 Joker 22 Set 1 ring spanner set

As the installation space becomes increasingly tight during screwdriving, tools are necessary that enable users to work successfully even in such situations. Narrow spaces require additional placement points of the tool.

Can spanners be modified so that the placement possibilities of the tool increase? The combination of the 7.5° pivoted mouth and the double hexagon geometry doubles the placement points.

A repeated 180° turn of the wrench around the longitudinal axis during screwdriving provides four placement possibilities, and bolts or screw heads can be engaged every 15°. The Joker 6003 with its smart mouth geometry significantly expands the range of uses in confined spaces.

The Joker 6003 will automatically find the respective placement point after every turn. The slim yet robust ring side is angled by 15° to the tool axis. The high-quality surface treatment achieves a high and long-lasting corrosion protection. With tool finder Take it easy: colour coding by size.

- 22-piece ring spanner set - particularly suitable for narrow installation spaces
- The special mouth geometry expands the placement possibilities of the tool
- The low return angle in the mouth “takes” the screw every 15°
- Slim ring side angled by 15°

### 6003 Joker 22 Set 1 ring spanner set



Code	EAN		
05020232001	221087		1
		<b>6003 Joker</b> 1x 5,5x105; 1x 6x105; 1x 7x110; 1x 8x115; 1x 9x120; 1x 10x125; 1x 11x135; 1x 12x148; 1x 13x160; 1x 14x167; 1x 15x174; 1x 16x182; 1x 17x190; 1x 18x210; 1x 19x230; 1x 20x230; 1x 21x260; 1x 22x260; 1x 24x280; 1x 27x300; 1x 30x330; 1x 32x360	

### 6003 Joker 15 Set 1 combination wrench set

- In robust pouch

#### 6003 Joker 15 Set 1 combination wrench set

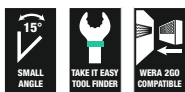

Code	EAN		
05020302001	222657		1
		<b>6003 Joker</b> 1x 5,5x105; 1x 6x105; 1x 7x110; 1x 8x115; 1x 9x120; 1x 10x125; 1x 11x135; 1x 12x148; 1x 13x160; 1x 14x167; 1x 15x174; 1x 16x182; 1x 17x190; 1x 18x210; 1x 19x230	
		<b>Hook and Loop Fastener Strip 240</b> 1x 50,0x240,0	

### 6003 Joker 11 Set 1 ring spanner set

- In robust pouch

#### 6003 Joker 11 Set 1 ring spanner set



Code	EAN		
05020231001	214195		1
		<b>6003 Joker</b> 1x 8x115; 1x 10x125; 1x 11x135; 1x 12x148; 1x 13x160; 1x 14x167; 1x 15x174; 1x 16x182; 1x 17x190; 1x 18x210; 1x 19x230	
		<b>Hook and Loop Fastener Strip 240</b> 1x 50,0x240,0	

### 6003 Joker 8 Imperial Set 1 ring spanner set, Imperial

- In robust pouch

#### 6003 Joker 8 Imperial Set 1 ring spanner set, Imperial

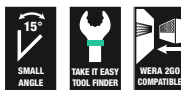

Code	EAN		
05020241001	214201		1
		<b>6003 Joker Imperial</b> 1x 5/16"x115; 1x 3/8"x125; 1x 7/16"x135; 1x 1/2"x160; 1x 9/16"x167; 1x 5/8"x182; 1x 11/16"x210; 1x 3/4"x230	
		<b>Hook and Loop Fastener Strip 240</b> 1x 50,0x240,0	

### 6003 Joker 5 Set 1 ring spanner set

- In robust pouch

#### 6003 Joker 5 Set 1 ring spanner set

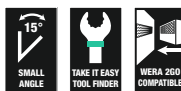

Code	EAN		
05020230001	214171		1
		<b>6003 Joker</b> 1x 8x115; 1x 10x125; 1x 13x160; 1x 17x190; 1x 19x230	
		<b>Hook and Loop Fastener Strip 120</b> 1x 50,0x120,0	

## Bicycle set 10

5-piece Joker 6003 spanner set; size 15 in an extra-slim design. As the working space is very narrow when working on your bike, tools are necessary that enable users to work successfully even in such situations. Narrow spaces require additional placement points of the tool.

Can spanners be modified so that the placement possibilities of the tool increase? The combination of the 7.5° pivoted mouth and the double hexagon geometry doubles the placement points. A repeated 180° turn of the wrench around the longitudinal axis during screwdriving provides four placement possibilities, and bolts or screw heads can be engaged every 15°.

The Joker 6003 with its smart mouth geometry significantly expands the range of uses in confined spaces. The Joker 6003 will automatically find the respective placement point after every turn.

The slim yet robust ring side is angled by 15° to the tool axis. The high-quality surface treatment achieves a high and long-lasting corrosion protection. With tool finder Take it easy: colour coding by size.

The Joker bags are suitable for attachment to walls, shelves, workshop trolleys and the Wera 2go system thanks to the hook and loop fastener system on the back.

- Particularly suitable for narrow screwdriving situations on the bike
- The special mouth geometry expands the placement possibilities of the tool
- The low return angle in the mouth "takes" the screw every 15°
- Slim ring side angled by 15°
- Joker 6003 pedal size 15 with flat mouth to mount and dismount pedals

### Bicycle set 10



Code	EAN		
05004178001	4013288 220653		1
		<b>6003 Joker</b> 1x 8x115; 1x 9x120; 1x 10x125; 1x 13x160	
		<b>6003 Joker Pedal</b> 1x 15x174	
		<b>Hook and Loop Fastener Strip 120</b> 1x 50,0x120,0	

## Bicycle set 12

12-piece Joker 6003 spanner set; size 15 in an extra-slim design. As the working space is very narrow when working on your bike, tools are necessary that enable users to work successfully even in such situations.

Narrow spaces require additional placement points of the tool. Can spanners be modified so that the placement possibilities of the tool increase?

The combination of the 7.5° pivoted mouth and the double hexagon geometry doubles the placement points. A repeated 180° turn of the wrench around the longitudinal axis during screwdriving provides four placement possibilities, and bolts or screw heads can be engaged every 15°.

The Joker 6003 with its smart mouth geometry significantly expands the range of uses in confined spaces. The Joker 6003 will automatically find the respective placement point after every turn. The slim yet robust ring side is angled by 15° to the tool axis. The high-quality surface treatment achieves a high and long-lasting corrosion protection. With tool finder Take it easy: colour coding by size.

The Joker bags are suitable for attachment to walls, shelves, workshop trolleys and the Wera 2go system thanks to the hook and loop fastener system on the back.

- Especially suitable for tight spaces
- The special mouth geometry expands the placement possibilities of the tool
- The low return angle in the mouth "takes" the screw every 15°
- Slim ring side angled by 15°
- Joker 6003 pedal size 15 with flat mouth to mount and dismount pedals
- With Take it easy tool finder: colour coding by size
- In robust pouch

### Bicycle set 12



Code	EAN		
05004181001	4013288 220721		1
		<b>6003 Joker</b> 1x 6x105; 1x 7x110; 1x 8x115; 1x 9x120; 1x 10x125; 1x 11x135; 1x 12x148; 1x 13x160; 1x 14x167; 1x 16x182; 1x 17x190	
		<b>6003 Joker Pedal</b> 1x 15x174	



### 6003 Joker 5 Imperial Set 1 ring spanner set, Imperial

- In robust pouch

### 6003 Joker 5 Imperial Set 1 ring spanner set, Imperial



Code	EAN		
05020240001	214188		1
		<b>6003 Joker Imperial</b> 1x 5/16"x115; 1x 3/8"x125; 1x 1/2"x160; 1x 9/16"x167; 1x 3/4"x230	
		<b>Hook and Loop Fastener Strip 120</b> 1x 50,0x120,0	

### 6003 Joker 4 Set 1 Ring spanner set

As the installation space becomes increasingly tight during screwdriving, it is necessary that tools enable users to work successfully even in such situations. Narrow spaces require additional placement points of the tool.

Can spanners be modified to increase the placement possibilities of the tool? The combination of the 7.5° pivoted mouth and the double hexagon geometry doubles the placement points.

A repeated 180° turn of the wrench around the longitudinal axis during screwdriving provides four placement possibilities, and bolts or screw heads can be engaged every 15°.

The Joker 6003 with its smart mouth geometry significantly expands the range of uses in confined spaces.

The Joker 6003 will automatically find the respective placement point after every turn. The slim yet robust ring side is angled by 15° to the tool axis.

The high-quality surface treatment achieves a high and long-lasting corrosion protection.

With Take it easy tool finder: Colour coding by size. The wear-free material of the clip guarantees easy removal and a secure hold of the spanners.

- Joker open-ended and combination wrenches and in a new clip for space-saving storage in the tool bag

### 6003 Joker 4 Set 1 Ring spanner set



Code	EAN		
05020228001	225665		1
		<b>6003 Joker</b> 1x 8x115; 1x 10x125; 1x 12x148; 1x 13x160	



### 6003 Joker 4 Set Imperial 1 Ring spanner set

- Joker open-ended and combination wrenches and in a new clip for space-saving storage in the tool bag

#### 6003 Joker 4 Set Imperial 1 Ring spanner set

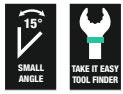

Code		EAN	1
05020229001	225672	4013288	
		<b>6003 Joker Imperial</b> 1x 9/16"x115; 1x 7/8"x125; 1x 7/16"x135; 1x 1/2"x160	

### 9640 Magnetic rail 6003 Joker 1 Ring spanner set

- 11-piece set
- With its strong magnet, the rail holds securely to metal surfaces. It can also be bolted to the wall
- The clips hold the tools perfectly

#### 9640 Magnetic rail 6003 Joker 1 Ring spanner set



Code		EAN	1
05020233001	228963	4013288	
		<b>6003 Joker</b> 1x 8x115; 1x 10x125; 1x 11x135; 1x 12x148; 1x 13x160; 1x 14x167; 1x 15x174; 1x 16x182; 1x 17x190; 1x 18x210; 1x 19x230,0	
		<b>9610</b> 1x 30,0x370,0	

### 9641 Magnetic rail 6003 Joker 2 Ring spanner set

- 5-piece set

#### 9641 Magnetic rail 6003 Joker 2 Ring spanner set

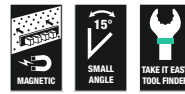

Code		EAN	1
05020234001	229854	4013288	
		<b>6003 Joker</b> 1x 8x115; 1x 10x125; 1x 13x160; 1x 17x190; 1x 19x230,0	
		<b>9610</b> 1x 30,0x370,0	

### 9642 Magnetic rail 6003 Joker Imperial 1 Ring spanner set

- Imperial
- 8-piece set

#### 9642 Magnetic rail 6003 Joker Imperial 1 Ring spanner set

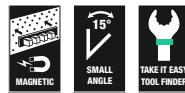

Code		EAN	1
05020235001	229878	4013288	
		<b>6003 Joker Imperial</b> 1x 9/16"x115; 1x 3/8"x125; 1x 7/16"x135; 1x 1/2"x160; 1x 9/16"x167; 1x 5/8"x182; 1x 11/16"x210; 1x 3/4"x230,0	
		<b>9610</b> 1x 30,0x370,0	

## 6004 Joker self-setting spanner

Many users wish to have a universal screwdriving tool with the widest possible range of applications. It should be a single tool for multiple metric and imperial dimensions.

It should automatically adjust to the different screw sizes. It should be safe to grab without damaging anything and allow for a high working speed. The continuous and parallel jaws replace several single spanner dimensions.

The required size is automatically and continuously set when attaching the tool to the hexagon bolt or screw. The integrated lever mechanism securely clamps the hexagon screw or bolt between the jaws, which significantly reduces the risk of slipping or damage.

The ratchet function ensures fast and consistent screwdriving without removing the tool. Thanks to the corner-width rectangular prisms, a back-pivoting angle of only 30° can be realized.

The single-arm design in conjunction with the ratchet function and the corner-width prism make it possible to work even in confined spaces.

The adjustable Joker 6004 is the universal screwdriving tool. Self-setting. Gripping. Spanning.

- The adjustable Joker 6004 covers all metric and imperial dimensions in the respective field of application
- Automatic and continuous grip of hexagon screws and bolts
- Lever mechanism when gripping avoids slipping and damage
- Fast and consistent screwdriving without removing the wrench thanks to mechanical ratchet function
- Back-pivoting angle of only 30° through placement in the corner-width rectangular prisms in the mouth

## 6004 Joker XS self-setting spanner



		EAN						
Code		4013288	mm		mm	mm		
05020099001		216892	7-10	1/4"-3/8"	117	7,7		3

## 6004 Joker S self-setting spanner



		EAN						
Code		4013288	mm		mm	mm		
05020100001		211729	10-13	7/16"-1/2"	154	10		3

## 6004 Joker M self-setting spanner



		EAN						
Code		4013288	mm		mm	mm		
05020103001		216908	13-16	1/2"-5/8"	188	12,4		3

### 6004 Joker L self-setting spanner



		EAN					
Code		4013288	mm		mm	mm	
05020101001		214706	16-19	5/8"-3/4"	224	14	3

### 6004 Joker XL self-setting spanner



		EAN					
Code		4013288	mm		mm	mm	
05020104001		216915	19-24	3/4"-15/16"	256	16	2

### 6004 Joker XXL self-setting spanner



		EAN					
Code		4013288	mm		mm	mm	
05020102001		214713	24-32	15/16"-1 1/4"	322	20	3

### 6004 Joker 4 set 1 self-setting spanner set

- The compact folding pouch with four adjustable Joker 6004 spanners covers all metric and imperial dimensions in applications from 7 to 19 mm or 1/4" to 3/4"

### 6004 Joker 4 set 1 self-setting spanner set



		EAN		
Code		4013288		
05020110001		217516		1
			6004 Joker XS 1x 7-10 (1/4"-3/8")x117	
			6004 Joker S 1x 10-13 (7/16"-1/2")x154	
			6004 Joker M 1x 13-16 (1/2"-5/8")x188	
			6004 Joker L 1x 16-19 (5/8"-3/4")x224	

### 6005 Joker Double open-ended wrenches

- Double open-ended wrench
- Especially suitable for tight spaces
- The special mouth geometry expands the placement possibilities of the tool
- The low return angle in the mouth "takes" the screw every 15°
- With Take it easy tool finder: colour coding by size

### 6005 Joker Double open-ended wrenches



Code	EAN								
Code	EAN		mm	mm	mm	mm	mm	mm	
05020310001	224873		6	16	7	17,7	4	3	
05020311001	224880		8	19	9	21	4,5	3	
05020312001	224897		10	23	11	25	5	3	
05020313001	224903		12	26	13	27	5,5	3	

### 6005 Joker 4 Set 1 Double open-ended wrench set

- Joker open-ended and combination wrenches and in a new clip for space-saving storage in the tool bag

### 6005 Joker 4 Set 1 Double open-ended wrench set



Code	EAN		
05020314001	224750		1
<b>6005 Joker Double</b> 1x 6x7x111,8; 1x 8x9x122,2; 1x 10x11x137,3; 1x 12x13x166			

### 9610 Joker Magnetic rail, for up to 11 spanners, empty

- With its strong magnet, the rail holds securely to metal surfaces. It can also be bolted to the wall
- The clips hold the tools perfectly

### 9610 Joker Magnetic rail, for up to 11 spanners, empty

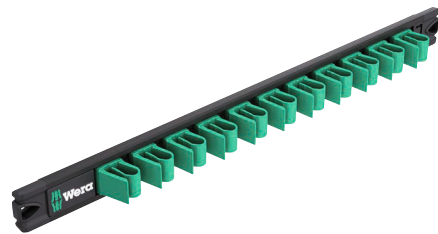

Code	EAN								
Code	EAN	mm	mm						
05136413001	228956	30,0	370,0						1





# L-Keys

## Hex-Plus - lets hexagon socket screws last longer

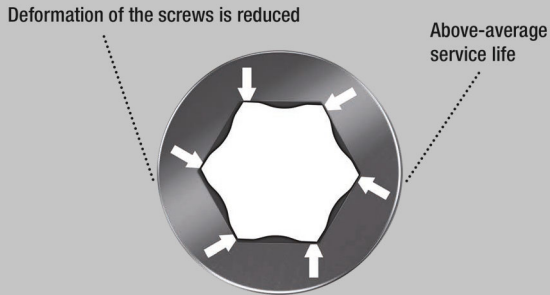

## Kraftform Stainless - stainless steel to prevent rust

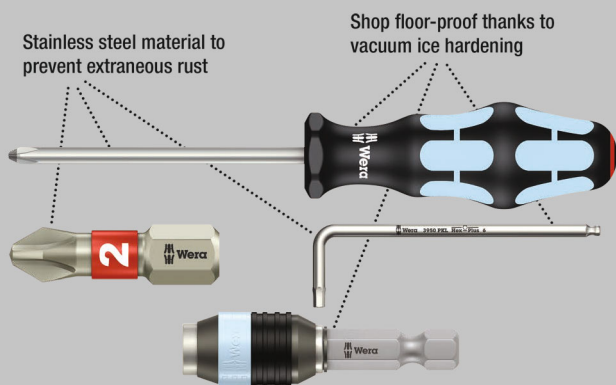

High quality L-key set out of stainless steel for hexagon socket screws by Wera. Stainless steel prevents the transfer of extraneous rust. The Hex-Plus profile offers a greater contact surface in the head of the screw.

The notching effect is therefore reduced to a minimum and damage to the screw head more or less eliminated. Come with hex ballpoint on the long arm: the ballpoint drive profile means that it is possible to swivel the tool axis away from the screwdriving axis, thus enabling "round the corner" screwdriving. Take it easy Tool Finder: colour coding according to size. In an almost wear-free L-key clip fastener.

- Solution to the extraneous rust problem: fasten stainless screws with stainless tools
- Hex-Plus allows socket head screws to live longer
- Take it easy tool finder with colour coding according to sizes
- Wear-resistant clip material for enhanced durability
- Colour coded, easy-to-grip plastic sleeve, even at low temperatures

## 3950/9 Hex-Plus Multicolour HF Stainless 1 L-key set, metric, stainless steel, with holding function

- From size 3.0, the holding function on the long arm will hold screws securely on the tool

### 3950/9 Hex-Plus Multicolour HF Stainless 1 L-key set, metric, stainless steel, with holding function



Code	EAN		
05022699001	4013288 224477		1
		<b>3950 SPKL Multicolour</b> 1x 1,5x90; 1x 2,0x101; 1x 2,5x112	
		<b>3950 SPKL Multicolour HF</b> 1x 3,0x123; 1x 4,0x137; 1x 5,0x154; 1x 6,0x172; 1x 8,0x195; 1x 10,0x224	

### 3950/9 Hex-Plus Multicolour Stainless 1 L-key set, metric, stainless



Code	EAN		
05022669001	4013288 185211		1
		<b>3950 SPKL Renkli</b> 1x 1,5x90; 1x 2,0x101; 1x 2,5x112; 1x 3,0x123; 1x 4,0x137; 1x 5,0x154; 1x 6,0x172; 1x 8,0x195; 1x 10,0x224	

### 3950/9 Hex-Plus Stainless 1 L-key set, metric, stainless

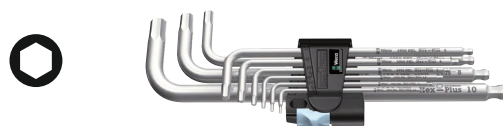

Code	EAN		
05022720001	4013288 111364		10
		<b>3950 PKL</b> 1x 1,5x90; 1x 2,0x101; 1x 2,5x112; 1x 3,0x123; 1x 4,0x137; 1x 5,0x154; 1x 6,0x172; 1x 8,0x195; 1x 10,0x224	



### 3950/9 Hex-Plus Stainless 1 SB L-key set, metric, stainless



Code	EAN		
05073544001	180377	3950 PKL	1
1x 1,5x90; 1x 2,0x101; 1x 2,5x112; 1x 3,0x123; 1x 4,0x137; 1x 5,0x154; 1x 6,0x172; 1x 8,0x195; 1x 10,0x224			

### 3950/9 Hex-Plus Imperial Stainless 1 L-key set, Imperial, stainless

- In robust pouch

### 3950/9 Hex-Plus Imperial Stainless 1 L-key set, imperial, stainless

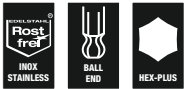

Code	EAN		
05022721001	117281	3950 PKL inch	1
1x 3/32"x112; 1x 7/64"x119; 1x 1/8"x123; 1x 9/64"x130; 1x 5/32"x137; 1x 3/16"x154; 1x 1/4"x185; 1x 5/16"x195; 1x 3/8"x224			

### 950/9 Hex-Plus Multicolour HF 1 L-key set, metric, BlackLaser, with holding function

- L-keys with retaining function for hexagon socket screws
- Hexagonal ballpoint on the long arm
- Colour coded, easy-to-grip plastic sleeve, even at low temperatures

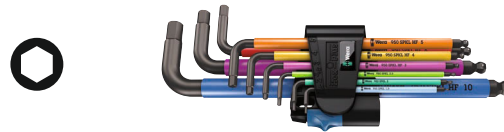

Code	EAN		
05022210001	188403	950 SPKL Multicolour	1
1x 1,5x90; 1x 2,0x101; 1x 2,5x112			
950 SPKL HF Multicolour 1x 3,0x123; 1x 4,0x137; 1x 5,0x154; 1x 6,0x172; 1x 8,0x195; 1x 10,0x224			

### 950/9 Hex-Plus Multicolour 1 L-key set, metric, BlackLaser



Code	EAN		
05022089001	180841	950 SPKL Multicolour	5
1x 1,5x90; 1x 2,0x101; 1x 2,5x112; 1x 3,0x123; 1x 4,0x137; 1x 5,0x154; 1x 6,0x172; 1x 8,0x195; 1x 10,0x224			

**950/9 Hex-Plus Multicolour 1 SB L-key set, metric, BlackLaser**



<b>Code</b>	<b>EAN</b>			
05073593001	165688		<b>950 SPKL Multicolour</b> 1x 1.5x90; 1x 2.0x101; 1x 2.5x112; 1x 3.0x123; 1x 4.0x137; 1x 5.0x154; 1x 6.0x172; 1x 8.0x195; 1x 10.0x224	1

**L-keys in a two-component clip**

L-keys fit securely into the clip

Solid rubber material for great durability

Sizes marked on the clip

Easy-to-use opening and closing mechanism



**950/9 Hex-Plus Multicolour 2 L-key set, metric, BlackLaser**



<b>Code</b>	<b>EAN</b>			
05133164001	207517		<b>950 SPKS Multicolour</b> 1x 1,5x50; 1x 2,0x56; 1x 2,5x63; 1x 3,0x71; 1x 4,0x80; 1x 5,0x90; 1x 6,0x100; 1x 8,0x112; 1x 10,0x125	1

**950/9 Hex-Plus Multicolour 3 L-key set, metric, BlackLaser**

9 L-keys with plastic sleeve (SPKL) made of circular, easy-grip material. The sleeve makes working comfortable even at low temperatures and is easy on the fingers.

All L-keys are easily accessible due to their colour coding and size markings. Convenient storage in the 9109 rack that can be set upright on the table or hung on the wall.

Clip 9539 integrated in the rack which can be removed for mobile use. On top of that, the rack includes a clever removable 9538 magnetiser that can be used to magnetise (and demagnetise) screws and tool tips; no more struggle to hold the screw with the second hand.

- Rack that can be set upright on the table or hung on the wall
- Integrated clip which can be removed for mobile use
- Removable magnet for magnetising and demagnetising tool tips
- L-keys for hexagonal socket screws
- Hex-Plus allows socket head screws to live longer
- Rubber sleeve for pleasant grip
- Hexagonal ballpoint on the long arm
- BlackLaser for high corrosion protection and long service life

**950/9 Hex-Plus Multicolour 3 L-key set, metric, BlackLaser**



<b>Code</b>	<b>EAN</b>			
05133165001	230294		<b>950 SPKL Multicolour</b> 1x 1,5x90; 1x 2,0x101; 1x 2,5x112; 1x 3,0x123; 1x 4,0x137; 1x 5,0x154; 1x 6,0x172; 1x 8,0x195; 1x 10,0x224	1
			9539	
			9109	
			9538	

### 3950/9 Hex-Plus Multicolour Imperial Stainless 1, imperial, stainless steel

Premium L-key set made of stainless steel for imperial hexagonal socket screws by Wera. Stainless steel prevents transmission of extraneous rust.

The Hex-Plus profile offers larger contact surfaces in the screw head. The notch effect is reduced to a minimum and the destruction of the screw head is almost eliminated.

With hexagonal ball tip at the long arm: The ball-shaped tip profiles enable the tool shaft to be moved and pivoted relative to the screw axis which allows screwdriving "around the corner".

Take it easy tool finder with colour coding by size. In an almost wear-free L-key clip.

### 3950/9 Hex-Plus Multicolour Imperial Stainless 1, imperial, stainless steel



	<b>Code</b>	<b>EAN</b>		
	05022860001	4013288 221360		1
			<b>3950 SPKL Multicolour Imperial</b> 1x 5/64"x101; 1x 3/32"x112; 1x 1/8"x123; 1x 5/32"x137; 1x 3/16"x154; 1x 7/32"x172; 1x 1/4"x185; 1x 5/16"x195; 1x 3/8"x224	

### 950/9 Hex-Plus Multicolour Imperial 1 L-key set, imperial, BlackLaser

- In robust pouch

### 950/9 Hex-Plus Multicolour Imperial 1 L-key set, imperial, BlackLaser



	<b>Code</b>	<b>EAN</b>		
	05022639001	4013288 182593		1
			<b>950 SPKL inch</b> 1x 5/64"x101; 1x 3/32"x112; 1x 1/8"x123; 1x 5/32"x137; 1x 3/16"x154; 1x 7/32"x172; 1x 1/4"x185; 1x 5/16"x195; 1x 3/8"x224	

### 950/9 Hex-Plus Multicolour imperial 2 L-key set, imperial, BlackLaser



	<b>Code</b>	<b>EAN</b>		
	05022640001	4013288 219107		1
			<b>950 SPKL inch</b> 1x 5/64"x101; 1x 3/32"x112; 1x 1/8"x123; 1x 5/32"x137; 1x 3/16"x154; 1x 7/32"x172; 1x 1/4"x185; 1x 5/16"x195; 1x 3/8"x224	

### 950/9 Hex-Plus Multicolour Imperial 3 L-key set, imperial, BlackLaser

- Imperial

### 950/9 Hex-Plus Multicolour Imperial 3 L-key set, imperial, BlackLaser



	<b>Code</b>	<b>EAN</b>		
	05022641001	4013288 230188		1
			<b>950 SPKS Multicolour, imperial</b> 1x 5/64"x50; 1x 3/32"x56; 1x 1/8"x63; 1x 5/32"x71; 1x 3/16"x80; 1x 7/32"x90; 1x 1/4"x100; 1x 5/16"x112; 1x 3/8"x125	

### 950/7 Hex-Plus Multicolour Magnet 1 L-key set, metric, BlackLaser

- For recessed screws, it's often advantageous for the screw to be held on the L-key by magnetic force. The Wera clips with magnetiser/demagnetiser enable a magnetisation/demagnetisation of L-keys in a flash

### 950/7 Hex-Plus Multicolour Magnet 1 L-key set, metric, BlackLaser

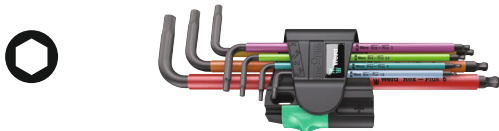

Code	EAN		
05022534001	4013288 183750		5
		<b>950 SPKL Multicolour</b> 1x 1,5x90; 1x 2,0x101; 1x 2,5x112; 1x 3,0x123; 1x 4,0x137; 1x 5,0x154; 1x 6,0x172	

### 950/9 L Hex-Plus HF 1 L-key set, metric, chrome-plated, with holding function

- The holding function on the long arm keeps screws securely on the tool
- High corrosion protection thanks to chrome-plating

### 950/9 L Hex-Plus HF 1 L-key set, metric, chrome-plated, with holding function



Code	EAN		
05022130001	4013288 207227		1
		<b>950 L</b> 1x 1,5x90 <sup>1)</sup> ; 1x 2,0x100; 1x 2,5x112	
		<b>950 L HF</b> 1x 3,0x126; 1x 4,0x140; 1x 5,0x160; 1x 6,0x180; 1x 8,0x200; 1x 10,0x219	

<sup>1)</sup>Regular hexagon

### 950/9 Hex-Plus 1 L-key set, metric, chrome-plated



Code	EAN		
05022087001	4013288 104816		10
		<b>950 PKL</b> 1x 1,5x90 <sup>1)</sup> ; 1x 2,0x100; 1x 2,5x112; 1x 3,0x126; 1x 4,0x140; 1x 5,0x160; 1x 6,0x180; 1x 8,0x200; 1x 10,0x219	

<sup>1)</sup>Regular hexagon

### 950/9 Hex-Plus 1 SB L-key set, metric, chrome-plated



Code	EAN		
05073391001	4013288 030160		1
		<b>950 PKL</b> 1x 1,5x90 <sup>1)</sup> ; 1x 2,0x100; 1x 2,5x112; 1x 3,0x126; 1x 4,0x140; 1x 5,0x160; 1x 6,0x180; 1x 8,0x200; 1x 10,0x219	

<sup>1)</sup>Regular hexagon

### 950/9 Hex-Plus 2 L-key set, metric, chrome-plated



Code	EAN		
05021909001	4013288 111937		10
		<b>950 L</b> 1x 1,5x90 <sup>1)</sup> ; 1x 2,0x100; 1x 2,5x112; 1x 3,0x126; 1x 4,0x140; 1x 5,0x160; 1x 6,0x180; 1x 8,0x200; 1x 10,0x219	

<sup>1)</sup>Regular hexagon

### 950/9 Hex-Plus 3 L-key set, metric, chrome-plated

- Short version
- Hexagonal ballpoint on the long arm

#### 950/9 Hex-Plus 3 L-key set, metric, chrome-plated



Code	EAN		
	4013288		
05133163001	112255		10
		<b>950 PKS</b> 1x 1,5x50 <sup>1)</sup> ; 1x 2,0x56; 1x 2,5x63; 1x 3,0x71; 1x 4,0x80; 1x 5,0x90; 1x 6,0x100; 1x 8,0x112; 1x 10,0x125	

<sup>1)</sup>Regular hexagon

### 950/9 Hex-Plus 4 L-key set, metric, chrome-plated

- Extra-short arm for use on difficult-to-access screws
- Hexagonal ballpoint on the long arm

#### 950/9 Hex-Plus 4 L-key set, metric, chrome-plated

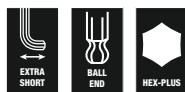

Code	EAN		
	4013288		
05073594001	139177		1
		<b>950 PKLS</b> 1x 1,5x90 <sup>1)</sup> ; 1x 2,0x100; 1x 2,5x112; 1x 3,0x126; 1x 4,0x140; 1x 5,0x160; 1x 6,0x180; 1x 8,0x200; 1x 10,0x219	

<sup>1)</sup>Regular hexagon

### 950/9 Hex-Plus 5 L-key set, metric, chrome-plated



Code	EAN		
	4013288		
05021406001	111890		10
		<b>950</b> 1x 1,5x45 <sup>1)</sup> ; 1x 2,0x50; 1x 2,5x56; 1x 3,0x63; 1x 4,0x70; 1x 5,0x80; 1x 6,0x90; 1x 8,0x100; 1x 10,0x112	

<sup>1)</sup>Regular hexagon.

### 950/9 Hex-Plus 6 L-key set, metric, BlackLaser

- BlackLaser for high corrosion protection and long service life

#### 950/9 Hex-Plus 6 L-key set, metric, BlackLaser



Code	EAN		
	4013288		
05022086001	104809		10
		<b>950 PKL BM</b> 1x 1,5x90 <sup>1)</sup> ; 1x 2,0x100; 1x 2,5x112; 1x 3,0x126; 1x 4,0x140; 1x 5,0x160; 1x 6,0x180; 1x 8,0x200; 1x 10,0x219	

<sup>1)</sup>Regular hexagon

### 950/9 Hex-Plus 6 SB L-key set, metric, BlackLaser



Code	EAN		
	4013288		
05073596001	106414		1
		<b>950 PKL BM</b> 1x 1,5x90 <sup>1)</sup> ; 1x 2,0x100; 1x 2,5x112; 1x 3,0x126; 1x 4,0x140; 1x 5,0x160; 1x 6,0x180; 1x 8,0x200; 1x 10,0x219	

<sup>1)</sup>Regular hexagon

### 950/9 Hex-Plus 7 L-key set, metric, BlackLaser

- Short version

#### 950/9 Hex-Plus 7 L-key set, metric, BlackLaser



Code	EAN		
	4013288		
05021737001	112286		10
		<b>950 BM</b> 1x 1,5x45 <sup>1)</sup> ; 1x 2,0x50; 1x 2,5x56; 1x 3,0x63; 1x 4,0x70; 1x 5,0x80; 1x 6,0x90; 1x 8,0x100; 1x 10,0x112	

<sup>1)</sup>Regular hexagon

### 950/9 Hex-Plus 8 L-key set, metric, chrome-plated

9 chrome-plated L-keys with Hex-Plus advantage to prevent rounded screws - a strong tool set for hexagonal socket screws.

Convenient storage in a rack that can be set upright on the table or hung on the wall.

Integrated clip which can be removed for mobile use. On top of that, the rack includes a clever removable magnetiser that can be used to magnetise (and demagnetise) screws and tool tips; no more struggle to hold the screw with the second hand.

- Rack that can be set upright on the table or hung on the wall
- Integrated clip which can be removed for mobile use
- Removable magnet for magnetising and demagnetising tool tips

### 950/9 Hex-Plus 8 L-key set, metric, chrome-plated



Code	EAN		
05022102001	4013288 230171		1
		<b>950 PKL</b> 1x 1,5x90 <sup>1)</sup> ; 1x 2,0x100; 1x 2,5x112; 1x 3,0x126; 1x 4,0x140; 1x 5,0x160; 1x 6,0x180; 1x 8,0x200; 1x 10,0x219	
		<b>9109</b>	
		<b>9536</b>	
		<b>9538</b>	

<sup>1)</sup>Regular hexagon

### 950/7 Hex-Plus Magnet 1 Magnetic L-key set, metric, chrome-plated

- For recessed screws, it's often advantageous for the screw to be held on the L-key by magnetic force. The Wera clips with magnetiser/demagnetiser enable a magnetisation/demagnetisation of L-keys in a flash.

### 950/7 Hex-Plus Magnet 1 Magnetic L-key set, metric, chrome-plated



Code	EAN		
05022101001	4013288 111968		10
		<b>950 PKL</b> 1x 1,5x90 <sup>1)</sup> ; 1x 2,0x100; 1x 2,5x112; 1x 3,0x126; 1x 4,0x140; 1x 5,0x160; 1x 6,0x180	

<sup>1)</sup>Regular hexagon

### 950/7 Hex-Plus 1 L-key set, metric, chrome-plated

- Hexagonal ballpoint on the long arm

### 950/7 Hex-Plus 1 L-key set, metric, chrome-plated



Code	EAN		
05022181001	4013288 111883		10
		<b>950 PKL</b> 1x 1,5x90 <sup>1)</sup> ; 1x 2,0x100; 1x 2,5x112; 1x 3,0x126; 1x 4,0x140; 1x 5,0x160; 1x 6,0x180	

<sup>1)</sup>Regular hexagon

### 950/13 Hex-Plus Imperial 1 L-key set, imperial, BlackLaser

- BlackLaser for high corrosion protection and long service life
- Hexagonal ballpoint on the long arm

#### 950/13 Hex-Plus Imperial 1 L-key set, imperial, BlackLaser

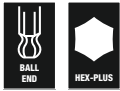

Code	EAN		
	4013288		
05021728001	111982		10
		<b>950 PKL inch</b> 1x 0,05"x83 <sup>1)</sup> ; 1x 1/16"x91 <sup>1)</sup> ; 1x 5/64"x100; 1x 3/32"x112; 1x 7/64"x119; 1x 1/8"x126; 1x 9/64"x132; 1x 5/32"x140; 1x 3/16"x160; 1x 7/32"x180; 1x 1/4"x190; 1x 5/16"x200; 1x 3/8"x212	
<sup>1)</sup> Regular hexagon			

### 950/13 Hex-Plus Imperial 1 SB L-key set, imperial, BlackLaser

Premium L-key set made of stainless steel for imperial hexagonal socket screws in convenient clip made of wear-free material for a permanently secure hold of the L-keys while also being easily accessible. L-keys with Hex-Plus profile which offers larger contact surfaces in the screw head.

The notch effect is reduced to a minimum and the destruction of the screw head is almost eliminated. The ball at the long arm allows safe working even in difficult installation positions.

The BlackLaser surface treatment makes for excellent surface protection, even from corrosion, and for long durability.

Lasered and therefore abrasion-proof size marking on the L-keys for quick access.

#### 950/13 Hex-Plus Imperial 1 SB L-key set, imperial, BlackLaser



Code	EAN		
	4013288		
05021721001	221315	<b>950 PKL Emperyal</b> 1x 0.05"x83 <sup>1)</sup> ; 1x 1/16"x91 <sup>1)</sup> ; 1x 5/64"x100; 1x 3/32"x112; 1x 7/64"x119; 1x 1/8"x126; 1x 9/64"x132; 1x 5/32"x140; 1x 3/16"x160; 1x 7/32"x180; 1x 1/4"x190; 1x 5/16"x200; 1x 3/8"x212	1
<sup>1)</sup> Regular hexagon			



### 950/9 Hex-Plus Imperial 1 L-key set, imperial, BlackLaser



Code	EAN		
05022171001	4013288 111975		10
		<b>950 PKL inch</b> 1x 5/64"x100; 1x 3/32"x112; 1x 1/8"x126; 1x 5/32"x140; 1x 3/16"x160; 1x 7/32"x180; 1x 1/4"x190; 1x 5/16"x200; 1x 3/8"x212	

### 950/9 Hex-Plus Imperial 1 SB L-key set, imperial, BlackLaser



Code	EAN		
05133180001	4013288 154118		1
		<b>950 PKL inch</b> 1x 5/64"x100; 1x 3/32"x112; 1x 1/8"x126; 1x 5/32"x140; 1x 3/16"x160; 1x 7/32"x180; 1x 1/4"x190; 1x 5/16"x200; 1x 3/8"x212	

### Bicycle Set 4

L-keys made from circular material with plastic sleeve for use on bicycles. The plastic sleeve makes working comfortable even at low temperatures and is easy on the fingers.

All L-keys are easily accessible due to their colour coding and size markings. For hexagonal socket screws and TORX® screws. In a robust and lightweight folding pouch.

- In a practical, lightweight folding pouch for easy carrying

### Bicycle Set 4



Code	EAN		
05004173001	4013288 211446		1
		<b>950 SPKL Multicolour</b> 1x 2,0x101; 1x 2,5x112	
		<b>950 SPKL HF Multicolour</b> 1x 3,0x123; 1x 4,0x137; 1x 5,0x154; 1x 6,0x172; 1x 8,0x195	
		<b>967 SXL TORX® HF Multicolour</b> 1x TX 10x112; 1x TX 25x154	
		<b>Hook and loop fastener strip 70</b> 1x 50,0x70,0	



### 3950 SPKL Multicolour HF L-key, metric, stainless steel, with holding function

High quality L-keys out of stainless steel for hexagonal socket screws by Wera. Stainless steel prevents the transfer of extraneous rust. The Hex-Plus profile offers a greater contact surface in the head of the screw.

The notching effect is therefore reduced to a minimum and damage to the screw head more or less eliminated. Come with hex ballpoint on the long arm: the ballpoint drive profile means that it is possible to swivel the tool axis away from the screwdriving axis, thus enabling "round the corner" screwdriving. Take it easy Tool Finder: colour coding according to size.

- Solution to the extraneous rust problem: fasten stainless screws with stainless tools
- Stainless L-keys prevent extraneous rust on stainless screws
- Hex-Plus allows socket head screws to live longer
- With holding function (HF) on the long arm to securely hold the screw on the tool
- The ball head on the long arm also allows offset use
- With Take it easy tool finder: colour coding by size
- All L-keys have a colour-coded, easy-grip hose sleeve for ergonomic and comfortable operation even at low temperatures
- With Take it easy tool finder: colour coding by size

### 3950 SPKL Multicolour HF L-key, metric, stainless steel, with holding function



Code	EAN		⊙	L <sub>1</sub>	L <sub>2</sub>	L <sub>3</sub>	L <sub>4</sub>	
	4013288		mm	mm	mm			
05022693001	224415		3,0	123	21	4 7/8"	27/32"	10
05022694001	224422		4,0	137	24	5 3/8"	1"	10
05022695001	224439		5,0	154	27	6 1/16"	1 1/16"	10
05022696001	224446		6,0	172	31	6 3/4"	1 1/4"	10
05022697001	224453		8,0	195	37	7 11/16"	1 7/16"	10
05022698001	224460		10,0	224	42	9"	1 11/16"	10

### 3950 SPKL Multicolour L-key, metric, stainless

High quality L-keys out of stainless steel for hexagonal socket screws by Wera. Stainless steel prevents the transfer of extraneous rust. The Hex-Plus profile offers a greater contact surface in the head of the screw.

The notching effect is therefore reduced to a minimum and damage to the screw head more or less eliminated.

Come with hex ballpoint on the long arm: the ballpoint drive profile means that it is possible to swivel the tool axis away from the screwdriving axis, thus enabling "round the corner" screwdriving.

Take it easy Tool Finder: colour coding according to size. In an almost wear-free L-key clip fastener.

- Solution to the extraneous rust problem: fasten stainless screws with stainless tools
- Hex-Plus allows socket head screws to live longer
- Stainless L-keys prevent extraneous rust on stainless screws
- Take it easy tool finder with colour coding according to sizes
- Wear-resistant clip material for enhanced durability

### 3950 SPKL Multicolour L-key, metric, stainless

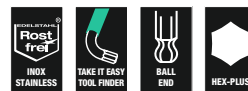

Code	EAN		⊙	L <sub>1</sub>	L <sub>2</sub>	L <sub>3</sub>	L <sub>4</sub>	
	4013288		mm	mm	mm			
05022660001	185792		1,5	90	14	3 1/2"	9/16"	10
05022661001	185808		2,0	101	16	4"	5/8"	10
05022662001	185815		2,5	112	19	4 7/16"	3/4"	10
05022663001	185822		3,0	123	21	4 7/8"	27/32"	10
05022664001	185839		4,0	137	24	5 3/8"	1"	10
05022665001	185846		5,0	154	27	6 1/16"	1 1/16"	10
05022666001	185860		6,0	172	31	6 3/4"	1 1/4"	10
05022667001	185877		8,0	195	37	7 11/16"	1 7/16"	10
05022668001	185884		10,0	224	42	9"	1 11/16"	10

### 3950 SPKL Multicolour L-keys, imperial, stainless



	EAN		⊙	L	L	L	L	
Code	4013288		mm	mm				
05022850001	221384		5/64"	101	16	4"	5/8"	10
05022851001	221469		3/32"	112	19	4 7/16"	3/4"	10
05022852001	221452		1/8"	123	21	4 7/8"	53/64"	10
05022853001	221445		5/32"	137	24	5 3/8"	5/16"	10
05022854001	221438		3/16"	154	27	6 1/16"	1 1/16"	10
05022855001	221377		7/32"	172	31	6 3/4"	1 7/32"	10
05022856001	221421		1/4"	185	34	7 1/4"	1 11/32"	10
05022857001	221414		5/16"	195	37	7 11/16"	1 29/64"	10
05022858001	221407		3/8"	224	42	9"	1 21/32"	10

### 3950 PKL L-key, metric, stainless



	EAN	⊙	L	L	L	L	
Code	4013288	mm	mm	mm			
05022700001	111265	1,5	90	14	3 1/2"	9/16"	10
05022701001	111272	2,0	101	16	4"	5/8"	10
05022702001	111289	2,5	112	19	4 7/16"	3/4"	10
05022703001	111296	3,0	123	21	4 7/8"	27/32"	10
05022704001	111302	4,0	137	24	5 3/8"	1"	10
05022705001	111319	5,0	154	27	6 1/16"	1 1/16"	10
05022706001	111326	6,0	172	31	6 3/4"	1 1/4"	10
05022708001	111340	8,0	195	37	7 11/16"	1 7/16"	10
05022709001	111357	10,0	224	42	9"	1 11/16"	10

### 3950 PKL L-key, imperial, stainless



	EAN	⊙	L	L	L	L	
Code	4013288	mm	mm				
05022710001	117151	3/32"	112	19	4 7/16"	3/4"	10
05022711001	117168	7/64"	119	20	4 3/4"	25/32"	10
05022712001	117175	1/8"	123	21	4 7/8"	27/32"	10
05022713001	117182	9/64"	130	22	5 3/16"	29/32"	10
05022714001	117199	5/32"	137	24	5 3/8"	1"	10
05022715001	117205	3/16"	154	27	6 1/16"	1 1/16"	10
05022716001	117212	1/4"	185	34	7 1/4"	1 5/16"	10
05022717001	117229	5/16"	195	37	7 11/16"	1 7/16"	10
05022718001	117236	3/8"	224	42	9"	1 11/16"	5

### 950 SPKL HF L-key Multicolour, metric, with holding function

- The holding function holds screws securely on the tool

### 950 SPKL HF L-key Multicolour, metric, with holding function



	EAN	⊙	L	L	L	L	
Code	4013288	mm	mm	mm			
05022200001	188342	3,0	123	21	4 7/8"	27/32"	10
05022201001	188359	4,0	137	24	5 3/8"	1"	10
05022202001	188366	5,0	154	27	6 1/16"	1 1/16"	10
05022203001	188373	6,0	172	31	6 3/4"	1 1/4"	10
05022204001	188380	8,0	195	37	7 11/16"	1 7/16"	10
05022205001	188397	10,0	224	42	9"	1 11/16"	10

### 950 SPKL L-key Multicolour, metric

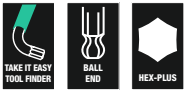

	EAN		⊘	L	L	L	L	
Code	4013288		mm	mm	mm			
05022600001	167842		1,5	90	14	3 1/2"	9/16"	10
05022602001	167934		2,0	101	16	4"	5/8"	10
05022604001	167859		2,5	112	19	4 7/8"	3/4"	10
05022606001	167866		3,0	123	21	4 7/8"	27/32"	10
05022608001	167873		4,0	137	24	5 3/8"	1"	10
05022610001	167880		5,0	154	27	6 1/16"	1 1/16"	10
05022612001	167897		6,0	172	31	6 3/4"	1 1/4"	10
05022614001	167903		8,0	195	37	7 11/16"	1 7/16"	10
05022616001	167910		10,0	224	42	9"	1 11/16"	10

### 950 SPKL L-key Multicolour, imperial



	EAN		⊘	L	L	L	L	
Code	4013288		mm	mm				
05022630001	182500		5/64"	101	16	4"	5/8"	10
05022631001	182517		3/32"	112	19	4 7/8"	3/4"	10
05022632001	182524		1/8"	123	21	4 7/8"	27/32"	10
05022633001	182531		5/32"	137	24	5 3/8"	1"	10
05022634001	182548		3/16"	154	27	6 1/16"	1 1/16"	10
05022635001	182555		7/32"	172	31	6 3/4"	1 1/4"	10
05022636001	182562		1/4"	185	34	7 1/4"	1 5/16"	10
05022637001	182579		5/16"	195	37	7 11/16"	1 7/16"	10
05022638001	182586		3/8"	224	42	9"	1 11/16"	10

### 950 SPKS L-key Multicolour, metric

- Short version

### 950 SPKS L-key Multicolour, metric

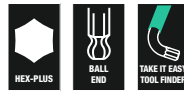

	EAN		⊘	L	L	L	L	
Code	4013288		mm	mm	mm			
05022678001	211910		1,5	50	14	2"	9/16"	10
05022670001	211934		2,0	56	16	2 7/32"	5/8"	10
05022671001	211927		2,5	63	19	2 1/2"	3/4"	10
05022672001	211941		3,0	71	21	2 3/4"	27/32"	10
05022673001	211958		4,0	80	24	3 1/8"	1"	10
05022674001	211965		5,0	90	27	3 1/2"	1 1/16"	10
05022675001	211972		6,0	100	31	4"	1 1/4"	10
05022676001	211989		8,0	112	37	4 7/16"	1 7/16"	10
05022677001	211996		10,0	125	42	5"	1 11/16"	10

### 950 SPKS L-key Multicolour, imperial, BlackLaser

- Short version
- Imperial

### 950 SPKS L-key Multicolour, imperial, BlackLaser



	EAN		⊘	L	L	L	L	
Code	4013288		mm	mm				
05022651001	230201		5/64"	50	14	2"	9/16"	10
05022652001	230195		3/32"	56	16	2 7/32"	5/8"	10
05022653001	230218		1/8"	63	19	2 1/2"	3/4"	10
05022654001	230232		5/32"	71	21	2 3/4"	27/32"	10
05022655001	230249		3/16"	80	24	3 1/8"	1"	10
05022656001	230256		7/32"	90	27	3 1/2"	1 1/16"	10
05022657001	230263		1/4"	100	31	4"	1 1/4"	10
05022658001	230270		5/16"	112	37	4 7/16"	1 7/16"	10
05022659001	230287		3/8"	125	42	5"	1 11/16"	10

### 950 PKL L-key, metric, chrome-plated

- High corrosion protection thanks to chrome-plating
- Hexagonal ballpoint on the long arm

### 950 PKL L-key, metric, chrome-plated



	EAN	⊘	L <sub>1</sub>	L <sub>2</sub>	L <sub>3</sub>	L <sub>4</sub>	
Code	4013288	mm	mm	mm			
05022050001 <sup>1)</sup>	018779	1,5	90	14	3 1/2"	9/16"	10
05022052001	018786	2,0	100	16	4"	5/8"	10
05022054001	018793	2,5	112	18	4 7/16"	23/32"	10
05022056001	018809	3,0	126	20	5"	25/32"	10
05022058001	018816	4,0	140	25	5 1/2"	1"	10
05022060001	018823	5,0	160	28	6 5/16"	1 3/32"	10
05022062001	018830	6,0	180	32	7 1/16"	1 1/4"	10
05022063001	037718	7,0	190	34	7 1/2"	1 5/16"	10
05022064001	018847	8,0	200	36	8"	1 7/16"	10
05022066001	018854	10,0	219	40	8 11/16"	1 9/16"	10
05022067001	038708	12,0	248	45	10"	1 3/4"	5

<sup>1)</sup>Regular hexagon

### 950 PKL BM L-key, metric, BlackLaser

- BlackLaser for high corrosion protection and long service life
- Hexagonal ballpoint on the long arm

### 950 PKL BM L-key, metric, BlackLaser



	EAN	⊘	L <sub>1</sub>	L <sub>2</sub>	L <sub>3</sub>	L <sub>4</sub>	
Code	4013288	mm	mm	mm			
05027101001 <sup>1)</sup>	094988	1,5	90	14	3 1/2"	9/16"	10
05027102001	094995	2,0	100	16	4"	5/8"	10
05027103001	095008	2,5	112	18	4 7/16"	23/32"	10
05027104001	095015	3,0	126	19	5"	3/4"	10
05027105001	095022	4,0	140	25	5 1/2"	1"	10
05027106001	095039	5,0	160	28	6 5/16"	1 3/32"	10
05027107001	095046	6,0	180	32	7 1/16"	1 1/4"	10
05027110001	095053	7,0	190	34	7 1/2"	1 5/16"	10
05027108001	095060	8,0	200	36	8"	1 7/16"	10
05027109001	095077	10,0	219	40	8 11/16"	1 9/16"	10
05027111001	095084	12,0	248	45	10"	1 3/4"	5

<sup>1)</sup>Regular hexagon

### 950 PKL L-key, imperial, BlackLaser



	EAN	⊘	L <sub>1</sub>	L <sub>2</sub>	L <sub>3</sub>	L <sub>4</sub>	
Code	4013288	mm	mm	mm			
05022079001 <sup>1)</sup>	041203	0,05"	83	14	3 1/4"	9/16"	10
05022081001 <sup>1)</sup>	041210	1/16"	91	15	3 1/2"	19/32"	10
05022068001	018861	5/64"	100	16	4"	5/8"	10
05022070001	018878	3/32"	112	18	4 7/16"	23/32"	10
05022071001	041227	7/64"	119	19	4 3/4"	3/4"	10
05022072001	018885	1/8"	126	20	5"	25/32"	10
05022073001	041234	9/64"	132	23	5 3/16"	29/32"	10
05022074001	018892	5/32"	140	25	5 1/2"	1"	10
05022076001	018908	3/16"	160	25	6 5/16"	1"	10
05022078001	018915	7/32"	180	27	7 1/16"	1 1/16"	10
05022080001	018922	1/4"	190	34	7 1/2"	1 5/16"	10
05022082001	018939	5/16"	200	36	8"	1 7/16"	10
05022095001	038739	3/8"	212	38	8 3/8"	1 1/2"	5
05022096001	038746	1/2"	224	40	9"	1 9/16"	5

<sup>1)</sup>Regular hexagon

### 950 PKLS Long Arm Ballpoint Hex Key, metric, chrome plated

- Extra-short arm for use on difficult-to-access screws

### 950 PKLS Long Arm Ballpoint Hex Key, metric, chrome plated



	EAN	⊘	L <sub>1</sub>	L <sub>2</sub>	L <sub>3</sub>	L <sub>4</sub>	
Code	4013288	mm	mm	mm			
05022040001 <sup>1)</sup>	139429	1,5	90	4,5	3 1/2"	11/64"	10
05022041001	139283	2,0	100	5,5	4"	7/32"	10
05022042001	139290	2,5	112	6,5	4 7/16"	1/4"	10
05022043001	139306	3,0	126	7,5	5"	19/64"	10
05022044001	139313	4,0	140	10,0	5 1/2"	25/64"	10
05022045001	139320	5,0	160	12	6 5/16"	15/32"	10
05022046001	139337	6,0	180	15	7 1/16"	19/32"	10
05022047001	139344	8,0	200	19	8"	3/4"	10
05022048001	139351	10,0	219	22	8 5/8"	7/8"	10

<sup>1)</sup>Regular hexagon

## 950 PKS L-key, metric, chrome-plated

- Short design for particularly confined screwdriving situations

### 950 PKS L-key, metric, chrome-plated

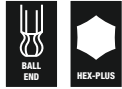

Code	EAN	⊘	L <sub>1</sub>	L <sub>2</sub>	L <sub>3</sub>	L <sub>4</sub>		
05133150001 <sup>1)</sup>	098047	1,5	50	14	2"	9/16"		10
05133151001	098054	2,0	56	16	2 7/32"	5/8"		10
05133152001	098061	2,5	63	18	2 1/2"	23/32"		10
05133153001	098078	3,0	71	20	2 3/4"	25/32"		10
05133154001	098085	4,0	80	22	3"	29/32"		10
05133155001	098092	5,0	90	25	3 1/2"	1"		10
05133156001	098108	6,0	100	28	4"	1 3/32"		10
05133157001	098115	8,0	112	32	4 7/16"	1 1/4"		10
05133158001	098122	10,0	125	36	5"	1 5/16"		10

<sup>1)</sup>Regular hexagon.

## 950 L HF L-key, metric, chrome-plated, with holding function

- The holding function on the long arm keeps screws securely on the tool

### 950 L HF L-key, metric, chrome-plated, with holding function



Code	EAN	⊘	L <sub>1</sub>	L <sub>2</sub>	L <sub>3</sub>	L <sub>4</sub>		
05022120001	207258	3,0	126	20	5"	25/32"		10
05022121001	207265	4,0	140	25	5 1/2"	1"		10
05022122001	207319	5,0	160	28	6 3/16"	1 3/32"		10
05022123001	207326	6,0	180	32	7 1/16"	1 1/4"		10
05022124001	207340	8,0	200	36	8"	1 7/16"		10
05022125001	207333	10,0	219	40	8 11/16"	1 9/16"		5

## 950 L-key, metric, chrome-plated



Code	EAN	⊘	L <sub>1</sub>	L <sub>2</sub>	L <sub>3</sub>	L <sub>4</sub>		
05021600001 <sup>1)</sup>	038722	1,5	90	14	3 1/2"	9/16"		10
05021605001	018656	2,0	100	16	4"	5/8"		10
05021610001	018663	2,5	112	18	4 7/16"	23/32"		10
05021615001	018670	3,0	126	20	5"	25/32"		10
05021620001	018687	4,0	140	25	5 1/2"	1"		10
05021625001	018694	5,0	160	28	6 5/16"	1 3/32"		10
05021630001	018700	6,0	180	32	7 1/16"	1 1/4"		10
05021632001	037701	7,0	190	30	7 1/2"	1 1/4"		10
05021635001	018717	8,0	200	36	8"	1 7/16"		10
05021640001	018724	10,0	219	40	8 11/16"	1 9/16"		5
05021645001	018731	12,0	250	45	10"	1 3/4"		5

<sup>1)</sup>Regular hexagon.

## 950 L-key, metric, chrome-plated



Code	EAN	⊘	L <sub>1</sub>	L <sub>2</sub>	L <sub>3</sub>	L <sub>4</sub>		
05021005001 <sup>1)</sup>	018267	1,5	45	14	1 3/4"	9/16"		10
05021010001	018274	2,0	50	16	2"	5/8"		10
05021015001	018281	2,5	56	18	2 7/32"	23/32"		10
05021020001	018298	3,0	63	20	2 1/2"	25/32"		10
05021025001	018304	3,5	66	23	2 5/8"	29/32"		10
05021030001	018311	4,0	70	25	2 3/4"	1"		10
05021035001	018328	4,5	75	26	3"	1 1/32"		10
05021040001	018335	5,0	80	28	3 1/8"	1 3/32"		10
05021045001	018342	6,0	90	32	3 1/2"	1 1/4"		10
05021050001	018359	7,0	95	34	3 3/4"	1 5/16"		10
05021055001	018366	8,0	100	36	4"	1 7/16"		10
05021060001	018373	9,0	106	38	4 3/16"	1 1/2"		10
05021065001	018380	10,0	112	40	4 7/16"	1 9/16"		10
05021070001	018397	11,0	120	43	4 3/4"	1 11/16"		10
05021075001	018403	12,0	125	45	5"	1 3/4"		10
05021080001	018410	13,0	132	50	5 3/16"	2"		10
05021085001 <sup>1)</sup>	018427	14,0	140	56	5 1/2"	2 7/32"		10
05021090001 <sup>1)</sup>	018434	17,0	160	63	6 5/16"	2 1/2"		5
05021095001 <sup>1)</sup>	018441	19,0	180	70	7 1/16"	2 3/4"		5

<sup>1)</sup>Regular hexagon.

## 950 BM L-key, metric, BlackLaser



Code	EAN	⌀	L <sub>1</sub>	L <sub>2</sub>	L <sub>3</sub>	L <sub>4</sub>		
05027201001 <sup>1)</sup>	095381	1,5	45	14	1 3/4"	9/16"		10
05027202001	095398	2,0	50	16	2"	5/8"		10
05027203001	095541	2,5	56	18	2 7/32"	23/32"		10
05027204001	095404	3,0	63	20	2 1/2"	25/32"		10
05027205001	095411	3,5	66	23	2 5/8"	29/32"		10
05027206001	095428	4,0	70	25	2 3/4"	1"		10
05027207001	095435	4,5	75	26	3"	1 1/32"		10
05027208001	095442	5,0	80	28	3 1/8"	1 3/32"		10
05027209001	095459	6,0	90	32	3 1/2"	1 1/4"		10
05027210001	095466	7,0	95	34	3 3/4"	1 5/16"		10
05027211001	095473	8,0	100	36	4"	1 7/16"		10
05027213001	095480	9,0	106	38	4 11/64"	1 1/2"		10
05027212001	095497	10,0	112	40	4 7/16"	1 9/16"		10
05027214001	095503	11,0	120	43	4 23/32"	1 11/16"		10
05027215001	095510	12,0	125	45	5"	1 49/64"		10

<sup>1)</sup>Regular hexagon

## Kraftform Stainless - stainless steel to prevent rust

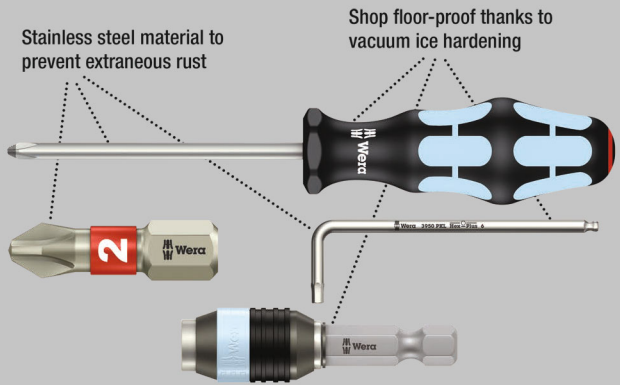

Set of high quality stainless steel L-keys for internal TORX® screws. Very corrosion-resistant due to ice-hardened stainless steel material of the L-key, avoiding the transmission of extraneous rust in stainless steel screw connections.

With holding function on the long arm: The clamping force resulting from the surface pressure between the output tip and the screw profile holds the screws securely on the tool.

With extra long arm for working in a low position.

The grip-friendly hose jacket facilitates screwdriving even at low temperatures. Take it easy tool finder with colour coding by size.

With a practical clip made of durable material for secure holding of the L-key while at the same time allowing easy removal.

- The holding function on the long arm keeps screws securely on the tool
- Extremely high corrosion protection thanks to ice-hardened stainless steel design
- Compact and easy to remove - stored in a 2-component plastic clip
- Handle-friendly hose jacket with tool finder Take it easy: Colour coding according to size

## TORX® Tools with holding function

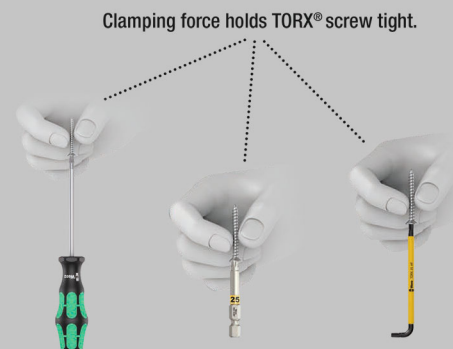

### 3967/9 TX SXL Multicolour HF Stainless 1 L-key set with holding function, stainless



Code	EAN		
05022689001	4013288 207128		1
<b>3967 SXL HF TORX® Multicolour</b> 1x TX 8x90; 1x TX 9x101; 1x TX 10x112; 1x TX 15x123; 1x TX 20x137; 1x TX 25x154; 1x TX 27x172; 1x TX 30x195; 1x TX 40x224			

### 967/9 TX XL Multicolour HF 1 L-key set with holding function, long

- With holding function (HF) on the long arm to securely hold the screw on the tool
- Long version
- Take it easy tool finder with colour coding according to sizes

### 967/9 TX XL Multicolour HF 1 L-key set with holding function, long



Code	EAN		
05024470001	4013288 193537		1
<b>967 SXL TORX® HF Multicolour</b> 1x TX 8x90; 1x TX 9x101; 1x TX 10x112; 1x TX 15x123; 1x TX 20x137; 1x TX 25x154; 1x TX 27x172; 1x TX 30x195; 1x TX 40x224			

### 967/9 TX Multicolour HF 1 L-key set with holding function

- With holding function (HF) on the long arm to securely hold the screw on the tool
- Take it easy tool finder with colour coding according to sizes

### 967/9 TX Multicolour HF 1 L-key set with holding function

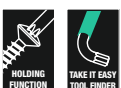

Code	EAN		
05024179001	4013288 185228		1
<b>967 SL TORX® HF</b> 1x TX 8x76; 1x TX 9x79; 1x TX 10x85; 1x TX 15x90; 1x TX 20x96; 1x TX 25x104; 1x TX 27x112; 1x TX 30x122; 1x TX 40x132			

### 967/9 TX XL HF 1 L-key set with holding function, long

- With holding function (HF) on the long arm to securely hold the screw on the tool
- Long version

### 967/9 TX XL HF 1 L-key set with holding function, long



Code	EAN		
05024450001	4013288 193513		1
<b>967 XL HF TORX®</b> 1x TX 8x90; 1x TX 9x101; 1x TX 10x112; 1x TX 15x123; 1x TX 20x137; 1x TX 25x154; 1x TX 27x172; 1x TX 30x195; 1x TX 40x224			

### 967/9 TX HF 1 L-key set with holding function, BlackLaser

- With holding function (HF) on the long arm to securely hold the screw on the tool

### 967/9 TX HF 1 L-key set with holding function, BlackLaser



Code	EAN		
05024244001	4013288 104953		10
<b>967 L TORX® HF</b> 1x TX 8x76; 1x TX 9x79; 1x TX 10x85; 1x TX 15x90; 1x TX 20x96; 1x TX 25x104; 1x TX 27x112; 1x TX 30x122; 1x TX 40x132			

### 967/9 TX XL Multicolour 1 Multicolour L-key set for TORX® screws, long



Code	EAN		
05024480001	4013288 193544		1
<b>967 SXL TORX® Multicolour</b> 1x TX 8x90; 1x TX 9x101; 1x TX 10x112			
<b>967 SPKXL TORX® Multicolour</b> 1x TX 15x123; 1x TX 20x137; 1x TX 25x154; 1x TX 27x172; 1x TX 30x195; 1x TX 40x224			

**967/9 TX BO Multicolour 1 L-key set for tamper-proof TORX® screws, BlackLaser**

- L-keys for TORX® BO screws to loosen safety connections

**967/9 TX BO Multicolour 1 L-key set for tamper-proof TORX® screws, BlackLaser**



Code	EAN		
	4013288		
05024335001	180858		10
		<b>967 SPKL TORX® BO Multicolour</b> 1x TX 8x76 <sup>1)</sup> ; 1x TX 9x79 <sup>1)</sup> ; 1x TX 10x85 <sup>2)</sup> ; 1x TX 15x90; 1x TX 20x96; 1x TX 25x104; 1x TX 27x112; 1x TX 30x122; 1x TX 40x132	

<sup>1)</sup>Product without bore hole at the short end and without ball-end at the long arm.  
<sup>2)</sup>Product without ball-end at the long arm.

**967/9 TX BO Multicolour 1 SB L-key set for tamper-proof TORX® screws, BlackLaser**



Code	EAN		
	4013288		
05073599001	170125	<b>967 SPKL TORX® BO Multicolour</b> 1x TX 8x76 <sup>1)</sup> ; 1x TX 9x79 <sup>1)</sup> ; 1x TX 10x85 <sup>2)</sup> ; 1x TX 15x90; 1x TX 20x96; 1x TX 25x104; 1x TX 27x112; 1x TX 30x122; 1x TX 40x132;	1

<sup>1)</sup>Product without bore hole at the short end and without ball-end at the long arm.  
<sup>2)</sup>Product without ball-end at the long arm.

**967/9 TX XL 1 TORX® L-key set, long**

- Long version

**967/9 TX XL 1 TORX® L-key set, long**



Code	EAN		
	4013288		
05024460001	193520		1
		<b>967 XL TORX®</b> 1x TX 8x90; 1x TX 9x101; 1x TX 10x112	
		<b>967 PKXL TORX®</b> 1x TX 15x123; 1x TX 20x137; 1x TX 25x154; 1x TX 27x172; 1x TX 30x195; 1x TX 40x224	

**967/9 TX 1 L-key set, BlackLaser**



Code	EAN		
	4013288		
05024242001	104946		10
		<b>967 PKL TORX®</b> 1x TX 8x76 <sup>1)</sup> ; 1x TX 9x79 <sup>1)</sup> ; 1x TX 10x85 <sup>1)</sup> ; 1x TX 15x90; 1x TX 20x96; 1x TX 25x104; 1x TX 27x112; 1x TX 30x122; 1x TX 40x132	

<sup>1)</sup>Product without ball-end at the long arm.

**967/9 TX 1 SB L-key set, BlackLaser**

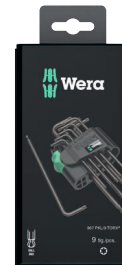

Code	EAN		
	4013288		
05073598001	106438	<b>967 PKL TORX®</b> 1x TX 8x76 <sup>1)</sup> ; 1x TX 9x79 <sup>1)</sup> ; 1x TX 10x85 <sup>1)</sup> ; 1x TX 15x90; 1x TX 20x96; 1x TX 25x104; 1x TX 27x112; 1x TX 30x122; 1x TX 40x132	1

<sup>1)</sup>Product without ball-end at the long arm.



## Kraftform Stainless - stainless steel to prevent rust

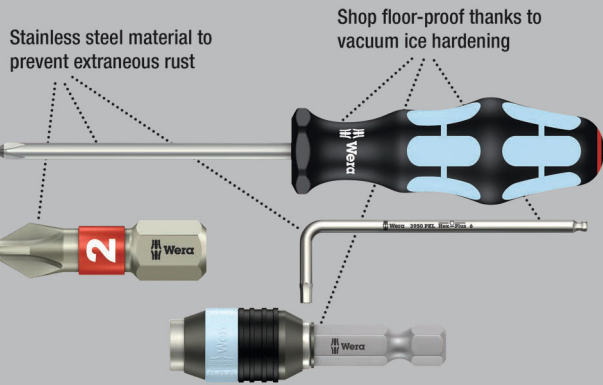

### 3967 SXL HF TORX® L-key Multicolour with holding function, long, stainless



Code	EAN		⬠	┌	└	┌	└	📦
Code	EAN			mm	mm			
05022680001	207135		TX 8	90	16	3 1/2"	5/8"	10
05022681001	207142		TX 9	101	16	4"	5/8"	10
05022682001	207159		TX 10	112	19	4 7/16"	3/4"	10
05022683001	207166		TX 15	123	21	4 7/8"	27/32"	10
05022684001	207173		TX 20	137	24	5 3/8"	1"	10
05022685001	207180		TX 25	154	27	6 1/16"	1 1/16"	10
05022686001	207197		TX 27	172	31	6 3/4"	1 1/4"	10
05022687001	207203		TX 30	195	37	7 11/16"	1 7/16"	10
05022688001	207210		TX 40	224	42	9"	1 11/16"	10

### 967 SXL HF TORX® L-key Multicolour with holding function, long

- With holding function (HF) on the long arm to securely hold the screw on the tool

### 967 SXL HF TORX® L-key Multicolour with holding function, long



Code	EAN		⬠	┌	└	┌	└	📦
Code	EAN			mm	mm			
05024471001	194145		TX 8	90	16	3 1/2"	5/8"	10
05024472001	194152		TX 9	101	16	4"	5/8"	10
05024473001	194169		TX 10	112	19	4 7/16"	3/4"	10
05024474001	194176		TX 15	123	21	4 7/8"	27/32"	10
05024475001	194183		TX 20	137	24	5 3/8"	1"	10
05024476001	194190		TX 25	154	27	6 1/16"	1 1/16"	10
05024477001	194206		TX 27	172	31	6 3/4"	1 1/4"	10
05024478001	194213		TX 30	195	37	7 11/16"	1 7/16"	10
05024479001	194220		TX 40	224	42	9"	1 11/16"	10

### 967 SPKXL TORX® L-key Multicolour, long

- Long design

### 967 SPKXL TORX® L-key Multicolour, long



Code	EAN		⬠	┌	└	┌	└	📦
Code	EAN			mm	mm			
05024484001	194305		TX 15	123	21	4 7/8"	27/32"	10
05024485001	194312		TX 20	137	24	5 3/8"	1"	10
05024486001	194329		TX 25	154	27	6 1/16"	1 1/16"	10
05024487001	194336		TX 27	172	31	6 3/4"	1 1/4"	10
05024488001	194343		TX 30	195	37	7 11/16"	1 7/16"	10
05024489001	194350		TX 40	224	42	9"	1 11/16"	10

### 967 SL TORX® HF L-key Multicolour with holding function

- With holding function (HF) on the long arm to securely hold the screw on the tool

### 967 SL TORX® HF L-key Multicolour with holding function



Code	EAN		⬠	┌	└	┌	└	📦
Code	EAN			mm	mm			
05024170001	185235		TX 8	76	16	3"	5/8"	5
05024171001	185242		TX 9	79	16	3 1/8"	5/8"	5
05024172001	185259		TX 10	85	17	3 1/4"	21/32"	5
05024173001	185266		TX 15	90	18	3 1/2"	23/32"	5
05024174001	185273		TX 20	96	19	3 3/4"	3/4"	5
05024175001	185280		TX 25	104	21	4 1/8"	27/32"	5
05024176001	185297		TX 27	112	22	4 7/16"	29/32"	5
05024177001	185303		TX 30	122	24	4 13/16"	1"	5
05024178001	185310		TX 40	132	27	5 3/16"	1 1/16"	5

### 967 SPKL TORX® B0 L-key Multicolour

- L-key for TORX® socket screws with safety pin

#### 967 SPKL TORX® B0 L-key Multicolour



Code	EAN							
Code	4013288			mm	mm			
05024350001 <sup>1)</sup>	172679		TX 8	76	16	3"	5/8"	10
05024351001 <sup>1)</sup>	172686		TX 9	79	16	3 1/8"	5/8"	10
05024352001 <sup>2)</sup>	172693		TX 10	85	17	3 3/8"	21/32"	10
05024353001	172709		TX 15	90	18	3 1/2"	23/32"	10
05024354001	172716		TX 20	96	19	3 3/4"	3/4"	10
05024355001	172723		TX 25	104	21	4 1/8"	27/32"	10
05024356001	172730		TX 27	112	22	4 7/16"	29/32"	10
05024357001	172747		TX 30	122	24	4 13/16"	1"	10
05024358001	172754		TX 40	132	27	5 3/16"	1 1/16"	10

<sup>1)</sup>Product without bore hole at the short and without ball-end at the long arm.  
<sup>2)</sup>Product without ball-end at the long arm.

### 967 SXL TORX® L-key Multicolour, long

- Long version

#### 967 SXL TORX® L-key Multicolour, long



Code	EAN							
Code	4013288			mm	mm			
05024481001	194275		TX 8	90	16	3 1/2"	5/8"	10
05024482001	194282		TX 9	101	16	4"	5/8"	10
05024483001	194299		TX 10	112	19	4 7/16"	3/4"	10

### 967 XL HF TORX® L-key with holding function, long

- With holding function (HF) on the long arm to securely hold the screw on the tool

#### 967 XL HF TORX® L-key with holding function, long



Code	EAN						
Code	4013288		mm	mm			
05024451001	193674	TX 8	90	16	3 1/2"	5/8"	10
05024452001	193681	TX 9	101	16	4"	5/8"	10
05024453001	193698	TX 10	112	19	4 7/16"	3/4"	10
05024454001	193704	TX 15	123	21	4 7/8"	27/32"	10
05024455001	193711	TX 20	137	24	5 3/8"	1"	10
05024456001	193728	TX 25	154	27	6 1/16"	1 1/16"	10
05024457001	193735	TX 27	172	31	6 3/4"	1 1/4"	10
05024458001	193742	TX 30	195	37	7 11/16"	1 7/16"	10
05024459001	193759	TX 40	224	42	9"	1 11/16"	10

### 967 PKXL TORX® L-key, long

- TORX® ballpoint on the long arm

#### 967 PKXL TORX® L-key, long



Code	EAN						
Code	4013288		mm	mm			
05024464001	194084	TX 15	123	21	4 7/8"	27/32"	10
05024465001	194091	TX 20	137	24	5 3/8"	1"	10
05024466001	194107	TX 25	154	27	6 1/16"	1 1/16"	10
05024467001	194114	TX 27	172	31	6 3/4"	1 1/4"	10
05024468001	194121	TX 30	195	37	7 11/16"	1 7/16"	10
05024469001	194138	TX 40	224	42	9"	1 21/32"	10

## 967 XL TORX® L-key, long

- Long design

### 967 XL TORX® L-key, long



	EAN						
Code	4013288		mm	mm			
05024461001	194053	TX 8	90	16	3 1/2"	5/8"	10
05024462001	194060	TX 9	101	16	4"	5/8"	10
05024463001	194077	TX 10	112	19	4 7/16"	3/4"	10

## 967 PKL TORX® L-key, BlackLaser

- TORX® ballpoint on the long arm

### 967 PKL TORX® L-key, BlackLaser



	EAN						
Code	4013288		mm	mm			
05024199001 <sup>1)</sup>	104939	TX 8	76	16	3"	5/8"	5
05024100001 <sup>1)</sup>	035035	TX 9	79	16	3 1/8"	5/8"	5
05024105001 <sup>1)</sup>	019431	TX 10	85	17	3 3/8"	21/32"	5
05024200001	019547	TX 15	90	18	3 1/2"	23/32"	5
05024202001	019554	TX 20	96	19	3 3/4"	3/4"	5
05024204001	019561	TX 25	104	21	4 1/8"	27/32"	5
05024206001	019578	TX 27	112	22	4 7/16"	29/32"	5
05024208001	019585	TX 30	122	24	4 13/16"	1"	5
05024210001	019592	TX 40	132	27	5 3/16"	1 1/16"	5

<sup>1)</sup>Product without ball-end at the long arm.

## 967 L TORX® HF L-key with holding function, BlackLaser

- With holding function (HF) on the long arm to securely hold the screw on the tool

### 967 L TORX® HF L-key with holding function, BlackLaser



	EAN						
Code	4013288		mm	mm			
05024160001	104847	TX 8	76	16	3"	5/8"	5
05024161001	104922	TX 9	79	16	3 1/8"	5/8"	5
05024162001	104854	TX 10	85	17	3 1/4"	21/32"	5
05024163001	104861	TX 15	90	18	3 1/2"	23/32"	5
05024164001	104878	TX 20	96	19	3 3/4"	3/4"	5
05024165001	104885	TX 25	104	21	4 1/8"	27/32"	5
05024166001	104892	TX 27	112	22	4 7/16"	29/32"	5
05024167001	104908	TX 30	122	24	4 13/16"	1"	5
05024168001	104915	TX 40	132	27	5 3/16"	1 1/16"	5

### 967 TORX® L-key, BlackLaser



	EAN						
Code	4013288		mm	mm			
05024001001	019257	TX 6	42	16	1 5/8"	5/8"	5
05024002001	019264	TX 7	48	16	1 7/8"	5/8"	5
05024003001	019271	TX 8	48	16	1 7/8"	5/8"	5
05024004001	019288	TX 9	48	16	1 7/8"	5/8"	5
05024005001	019295	TX 10	51	17	2"	21/32"	5
05024008001	019301	TX 15	54	18	2 1/8"	23/32"	5
05024010001	019318	TX 20	57	19	2 1/4"	3/4"	5
05024012001	019325	TX 25	60	20	2 3/8"	25/32"	5
05024013001	019332	TX 27	64	21	2 1/2"	27/32"	5
05024015001	019349	TX 30	70	24	2 3/4"	1"	5
05024020001	019356	TX 40	76	26	3"	1 1/32"	5



# Kraftform Kompakt



## Kraftform Kompakt Turbo 1

Many users would like to be able to carry out screwdriving processes faster without compromise. With a screwdriver that is precise, allows powerful screwdriving, and is much faster than a conventional screwdriver.

A part-time universal gear is the solution: Integrated in the screwdriver handle, it quadruples the working speed with smooth couplings - purely mechanically.

One hand holds the front part of the handle, the other hand turns the rear part of the handle. The turbo function can be switched on or off at the push of a button.

Turning it off is recommended for tightening and loosening with high torque, e.g. for screw connections in wood, as well as for fine adjustments. Robust, maintenance-free gear made of steel with a maximum torque of 14Nm when the turbo function is deactivated.

Thanks to the Rapidaptor bit holder, the Kraftform Turbo can be used with all conventional 1/4" hexagon bits for a wide variety of screw profiles.

With the Rapidaptor function the bits can be inserted directly and can be easily removed by pushing the sleeve forward.

- 4 times the screwdriving speed thanks to the turbo function (purely mechanical - without battery)
- Activate and deactivate the turbo function by a simple push of a button
- Turbo function especially for smooth couplings
- Can be used without the turbo function like a normal screwdriver, e.g. for timber couplings with steadily increasing torque
- Robust, maintenance-free gear made of steel

## Kraftform Kompakt Turbo 1



Code	EAN		
05057482001	4013288 214614		1
		● 826 T Kraftform Turbo 1x 1/4"x146	
		⊕ 851/4 Z 1x PH 1x89; 1x PH 2x89; 1x PH 3x89 <sup>1)</sup>	
		⊕ 855/4 Z 1x PZ 1x89; 1x PZ 2x89; 1x PZ 3x89 <sup>1)</sup>	
		⊕ 867/4 Z TORX® 1x TX 10x89; 1x TX 15x89; 1x TX 20x89; 1x TX 25x89; 1x TX 30x89	
		○ 840/4 Z 1x 3,0x89; 1x 4,0x89; 1x 5,0x89; 1x 6,0x89 <sup>1)</sup>	
		● 800/4 Z 1x 0,8x4,0x89; 1x 1,0x5,5x89; 1x 1,2x6,5x89	
		Hook and Loop Fastener Strip 120 1x 50,0x120,0	

<sup>1)</sup>Hexagonal blade

## Kraftform Kompakt Turbo Imperial 1



Code	EAN		
05057483001	4013288 214621		1
		● 826 T Kraftform Turbo 1x 1/4"x146	
		⊕ 851/4 Z PH 1x PH 1x89; 1x PH 2x89; 1x PH 3x89 <sup>1)</sup>	
		⊕ 867/4 Z TORX® 1x TX 10x89; 1x TX 15x89; 1x TX 20x89; 1x TX 25x89; 1x TX 30x89	
		○ 840/4 Z Hex-Plus 1x 3/32"x89; 1x 1/8"x89; 1x 5/32"x89; 1x 3/16"x89	
		○ 868/4 Square-Plus 1x # 1x89; 1x # 2x89; 1x # 3x89	
		● 800/4 Z 1x 0,8x4,0x89; 1x 1,0x5,5x89; 1x 1,2x6,5x89	
		Hook and Loop Fastener Strip 120 1x 50,0x120,0	

<sup>1)</sup>Hexagonal blade

### 826 T Kraftform Turbo bits handholder with Rapidaptor quick-release chuck

- 4 times the screwdriving speed thanks to the turbo function (purely mechanical - without battery)
- Activate and deactivate the turbo function by a simple push of a button
- Turbo function especially for smooth couplings
- Can be used without the turbo function like a normal screwdriver, e.g. for timber couplings with steadily increasing torque
- Robust, maintenance-free gear made of steel

### 826 T Kraftform Turbo bits handholder with Rapidaptor quick-release chuck



Code	EAN	⌀	l					
05057480001	214591	1/4"	146					1

### Kraftform Kompakt 10, 12

9 tough viscous Wera bits for universal use. Torsion design to combat premature wear.

1 holder 813 R Kraftform with Rapidaptor quick-release chuck; multi-component for high working speeds and particularly ergonomic screwdriving.

- Kraftform holder with Rapidaptor quick-release chuck
- Torsion design of the bits against premature wear
- Tough viscous bits for universal use
- Convenient and robust storage

### Kraftform Kompakt 10



Code	EAN			
05056653001	041647			1
		●	<b>813 R</b> 1x 1/4"x90	
		+	<b>851/1 TZ PH</b> 1x PH 1x25; 1x PH 2x25	
		+	<b>855/1 TZ PZ</b> 1x PZ 1x25; 1x PZ 2x25	
		✳	<b>867/1 TZ TORX®</b> 1x TX 10x25; 1x TX 15x25; 1x TX 20x25	
		◌	<b>800/1 TZ</b> 1x 0,5x4,0x25; 1x 1,0x5,5x25	

### Kraftform Kompakt 12



Code	EAN			
05135942001	155887			1
		●	<b>813 R</b> 1x 1/4"x90	
		+	<b>851/1 J</b> 1x PH 00x25x2,0 <sup>1)</sup> ; 1x PH 0x25x2,5 <sup>2)</sup> ; 1x PH 1x25x3,0	
		+	<b>851/1 TZ PH</b> 1x PH 2x25	
		✳	<b>867/1 TZ TORX®</b> 1x TX 5x25; 1x TX 6x25; 1x TX 7x25; 1x TX 8x25; 1x TX 9x25	

<sup>1)</sup>Size 00 modified according to JCIS 00 (Japanese Camera Industrial Standard)

<sup>2)</sup>Size 0 modified according to JCIS 0 (Japanese Camera Industrial Standard)

## Kraftform Kompakt 20 - the right tool for machine or hand

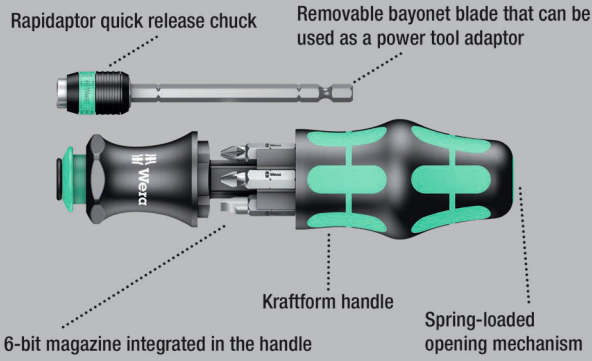

Wera compact tools enable the simultaneous use for the two types of fastening “manual” and “power tool”. The handle/interchangeable system in a compact design with various blade tips in a minimum of space make the user mobile and flexible.

Suitable for bits with 1/4" hexagon head drive as per DIN ISO 1173-C 6.3 und E 6.3 (ISO 1173) and Wera connecting series 1 and 4. Comes with an extension, bayonet, Rapidaptor technology.

Kraftform handle with non-roll feature, multi-component for particularly ergonomic screwdriving. Integrated magazine for the storage of the bits. In this way, this set replaces a 6-piece screwdriver set and reduces the equipment required to a minimum.

The profile and size of the bits are easy to recognise thanks to the Wera Take it easy Tool Finder with its colour coding and clearly visible imprint.

- Kraftform holder with bayonet blade and Rapidaptor quick-release chuck
- Kraftform handle with anti-roll feature, multi-component and integrated magazine
- Retractable bayonet blade
- Take it easy tool finder: colour coding according to profile and size
- In robust pouch

## Take it easy tool finder with color markings - for quick tool identification

Bits: Take it easy tool finder .....

Zyklop sockets: Take it easy tool finder .....

L-Keys: Take it easy tool finder .....

Joker: Take it easy tool finder .....

## Kraftform Kompakt 20 Tool Finder 1 with pouch



Code	EAN		
05051016001	4013288 185327		1
		889/4 R 1x 1/4"x100	
		851/1 BTZ 1x PH 1x25; 1x PH 2x25	
		855/1 BTZ 1x PZ 1x25; 1x PZ 2x25	
		867/1 TORX® BTZ 1x TX 25x25	
		800/1 BTZ 1x 0,8x5,5x25	
		Hook and Loop Fastener Strip 70 1x 50,0x70,0	



### Kraftform Kompakt 20 Tool Finder 2 with pouch

13-piece Kraftform Kompakt set with 6x 25 mm long and 6x 89 mm long bits. Wera's compact tools allow the simultaneous use of both types of screw connections; "hand" or "machine".

The handle blade-change system in a compact design with different compact blade tips makes the user mobile and flexible. Suitable for bits with 1/4" hexagonal drive as per DIN ISO 1173-C 6.3 and E 6.3 (ISO 1173) and Wera connection series 1 and 4.

With connecting adapter, bayonet, Rapidaptor technology, Kraftform handle with anti-roll protection, multi-components allow for particularly ergonomic screwdriving. Integrated magazine for storing 25 mm long bits.

This set replaces a 12-piece screwdriver set and reduces the necessary equipment to a minimum.

Profile and size of the bits are easily recognizable due to the Wera Take it easy tool finder with its colour coding and easily visible labels.

- 6x25mm bits with Take it easy tool finder: colour coding by profile and size stamping and 6x89mm bits

### Kraftform Kompakt 20 Tool Finder 2 with pouch



Code	EAN			
05051017001	4013288 211224			1
		●○	<b>889/4 R</b> 1x 1/4"x100	
		+	<b>851/1 BTZ</b> 1x PH 1x25; 1x PH 2x25	
		+	<b>855/1 BTZ</b> 1x PZ 1x25; 1x PZ 2x25	
		+	<b>867/1 TORX® BTZ</b> 1x TX 20x25; 1x TX 25x25	
		+	<b>851/4 Z</b> 1x PH 1x89; 1x PH 2x89	
		+	<b>855/4 Z</b> 1x PZ 1x89; 1x PZ 2x89	
		+	<b>867/4 Z TORX®</b> 1x TX 20x89; 1x TX 25x89	
			<b>Hook and Loop Fastener Strip 70</b> 1x 50,0x70,0	

### Kraftform Kompakt 20 with pouch



Code	EAN			
05051021001	4013288 098917			1
		●○	<b>889/4 R</b> 1x 1/4"x100	
		+	<b>851/1 Z</b> 1x PH 1x25; 1x PH 2x25	
		+	<b>855/1 Z</b> 1x PZ 1x25; 1x PZ 2x25	
		●	<b>800/1 Z</b> 1x 1,0x5,5x25; 1x 1,2x6,5x25	
			<b>Hook and Loop Fastener Strip 70</b> 1x 50,0x70,0	

### Kraftform Kompakt 25 with pouch



Code	EAN		
05051024001	4013288 098931		1
		<b>889/4 R</b> 1x 1/4"x100	
		<b>851/1 Z</b> 1x PH 1x25; 1x PH 2x25; 1x PH 3x25	
		<b>800/1 Z</b> 1x 0,6x4,5x25; 1x 1,0x5,5x25; 1x 1,2x6,5x25	
		<b>Hook and Loop Fastener Strip 70</b> 1x 50,0x70,0	

### Kraftform Kompakt 26 with pouch



Code	EAN		
05051025001	4013288 098948		1
		<b>889/4 R</b> 1x 1/4"x100	
		<b>851/1 Z</b> 1x PH 1x25; 1x PH 2x25	
		<b>800/1 Z</b> 1x 1,0x5,5x25; 1x 1,2x6,5x25	
		<b>868/1 Z</b> 1x # 1x25; 1x # 2x25	
		<b>Hook and Loop Fastener Strip 70</b> 1x 50,0x70,0	

### Kraftform Kompakt 27 XL Universal 1

Bit set for universal use. Bitholding screwdriver with 300 mm long blade and very slim, lockable bit mounting to reach areas which are difficult to access.

Thanks to the particularly slim design, even screws in very tight installation spaces can be operated. Multi-component Kraftform handle for high working speeds and particularly ergonomic screwdriving. Magazine integrated in the handle for bit storage.

6 tough, 25 mm length bits (Phillips-head Phillips and Pozidriv and TORX®). This set replaces a 6-piece screwdriver set and reduces the necessary equipment to a minimum. With hexagon anti-roll protection against rolling away.

- For universal use
- 300 mm long rigid blade
- Bit holder with very slim design for work in confined spaces
- Secure bit holding feature due to locking mechanism. With strong permanent magnet.
- Compact stainless steel holder for bits with 1/4" - external hexagon drive as per DIN 3126, ISO 1173 Form C 6.3 and E 6,3
- 6 tough bits, for universal use

### Kraftform Kompakt 27 XL Universal 1



Code	EAN		
05051028001	4013288 229588		1
		<b>851/1 BTZ</b> 1x PH 1x25; 1x PH 2x25	
		<b>855/1 BTZ</b> 1x PZ 2x25	
		<b>867/1 TORX® BTZ</b> 1x TX 15x25; 1x TX 20x25; 1x TX 25x25	
		<b>394 S</b> 1x 1/4"x300	

### Kraftform Kompakt 27 XL Universal Imperial Set 1

- With 6 bits in the magazine: Phillips-head Phillips, slotted and square head (Robertson); tough

#### Kraftform Kompakt 27 XL Universal Imperial Set 1



Code	EAN			
05051032001	229724			1
		+	851/1 Z 1x PH 1x25; 1x PH 2x25	
		-	800/1 Z 1x 1,0x5,5x25; 1x 1,2x6,5x25	
		□	868/1 Z 1x # 1x25; 1x # 2x25	
		●	394 S 1x 1/4"x300	

### Kraftform Kompakt 27 XL SHK 1

- Particularly suitable for applications in plumbing, heating and air conditioning

#### Kraftform Kompakt 27 XL SHK 1



Code	EAN			
05136075001	228994			1
		+	851/1 Z 1x PH 2x25	
		★	867/1 TORX® 1x TX 15x25; 1x TX 20x25; 1x TX 25x25	
		○	840/1 Z 1x 5,0x25; 1x 6,0x25	
		●	394 S 1x 1/4"x300	

### Kraftform Kompakt 27 Set 1

Wera compact tools with multi-component Kraftform handle for high working speeds and particularly ergonomic screwdriving. Bit magazine integrated in the handle, 6 bits with Torsion zone to prevent the bit tip from twisting at high loads. This significantly increases product life.

With Take it easy tool finder: Colour coding by profile and size stamping. Bit holder with strong permanent magnet for secure seating of the bit.

- Bit-holding handle with bit magazine
- Bit holder with strong permanent magnet which holds bits firmly
- With 6 BiTorsion bits in the magazine: Phillips-head Phillips and Pozidriv, TORX® and slotted; tough
- Take it easy tool finder: colour coding according to profile and size

#### Kraftform Kompakt 27 Set 1



Code	EAN			
05051510001	226556			1
		●	828/1 1x 1/4"	
		+	851/1 BTZ 1x PH 1x25; 1x PH 2x25	
		⊕	855/1 BTZ 1x PZ 2x25	
		★	867/1 TORX® BTZ 1x TX 20x25; 1x TX 25x25	
		-	800/1 BTZ 1x 0,8x5,5x25	

### Kraftform Kompakt 27 Set 2

- With 6 bits in the magazine: Phillips-head Phillips and slotted; tough

#### Kraftform Kompakt 27 Set 2



Code	EAN		
05051511001	4013288 226587		1
		828/1 1x 1/4"	
		851/1 Z 1x PH 1x25; 1x PH 2x25; 1x PH 3x25	
		800/1 Z 1x 0,6x4,5x25; 1x 1,0x5,5x25; 1x 1,2x6,5x25	

### Kraftform Kompakt 27 Imperial Set 1

- With 6 bits in the magazine: Phillips-head Phillips, slotted and square head (Robertson); tough

#### Kraftform Kompakt 27 Imperial Set 1



Code	EAN		
05051512001	4013288 226594		1
		828/1 1x 1/4"	
		851/1 Z 1x PH 1x25; 1x PH 2x25	
		800/1 Z 1x 1,0x5,5x25; 1x 1,2x6,5x25	
		868/1 Z 1x # 1x25; 1x # 2x25	

### Kraftform Kompakt 28 SB

Wera compact tool with multi-component Kraftform handle for high working speeds and particularly ergonomic screwdriving. Integrated bit magazine in the handle for the storage of 6 bits.

The bayonet blade can be lowered into the handle in confined screwdriving situations; it can be removed for insertion in a power tool. The retaining ring and the strong permanent magnet ensure a secure fit of the bit.

- Adaptor bayonet with stainless sleeve, retaining ring and strong permanent magnet
- Tough viscous bits for universal use

#### Kraftform Kompakt 28 SB

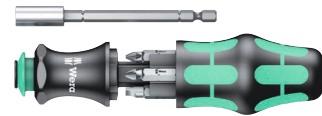

Code	EAN		
05073240001	4013288 138927		1
		851/1 Z PH 1x PH 1x25; 1x PH 2x25	
		855/1 Z PZ 1x PZ 1x25; 1x PZ 2x25	
		800/1 Z 1x 1,0x5,5x25; 1x 1,2x6,5x25	

#### Kraftform Kompakt 28 Imperial 1

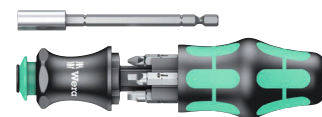

Code	EAN		
05073241001	4013288 214676		1
		851/1 Z PH 1x PH 1x25; 1x PH 2x25	
		868/1 Z 1x # 1x25; 1x # 2x25	
		800/1 Z 1x 1,0x5,5x25; 1x 1,2x6,5x25	

### Kraftform Kompakt 28 with pouch



Code	EAN		
	4013288		
05134491001	175373		1
			<b>851/1 Z</b> 1x PH 1x25; 1x PH 2x25
			<b>855/1 Z</b> 1x PZ 1x25; 1x PZ 2x25
			<b>800/1 Z</b> 1x 1,0x5,5x25; 1x 1,2x6,5x25
			<b>Hook and Loop Fastener Strip 70</b> 1x 50,0x70,0

### Kraftform Kompakt 40 and 41

- Pouch with 89 mm-long bits
- Kraftform holder with Rapidaptor quick-release chuck
- Rapidaptor quick-release chuck allows rapid bit change
- Tough viscous bits for universal use
- Ergonomic Kraftform handle for low-fatigue working

### Kraftform Kompakt 40



Code	EAN		
	4013288		
05059298001	096319		1
			<b>816 R</b> 1x 1/4"x119
			<b>851/4 Z</b> 1x PH 1x89; 1x PH 2x89
			<b>855/4 Z</b> 1x PZ 1x89; 1x PZ 2x89
			<b>800/4 Z</b> 1x 1,0x5,5x89; 1x 1,2x6,5x89
			<b>Hook and Loop Fastener Strip 70</b> 1x 50,0x70,0

### Kraftform Kompakt 41



Code	EAN		
	4013288		
05059299001	096326		1
			<b>816 R</b> 1x 1/4"x119
			<b>851/4 Z</b> 1x PH 1x89; 1x PH 2x89; 1x PH 3x89 <sup>1)</sup>
			<b>855/4 Z</b> 1x PZ 1x89; 1x PZ 2x89; 1x PZ 3x89 <sup>1)</sup>
			<b>867/4 Z TORX® B0</b> 1x TX 15x89; 1x TX 20x89; 1x TX 25x89; 1x TX 30x89
			<b>Hook and Loop Fastener Strip 70</b> 1x 50,0x70,0

<sup>1)</sup>Hexagonal blade



### Kraftform Kompakt 60 Torque 1.2 - 3.0 Nm

Pouch with bits in a length of 89 mm. Includes torque screwdriver 7441 with Rapidaptor quick-release chuck and multi-component Kraftform handle for low-fatigue working. Suitable for manual and power tool operations. 17-piece; compact handle/interchangeable blade system for torque-controlled tightening. Includes torque holder 7441, settings from 1.2 to 3.0 Nm. Adjustable in 0.10 Nm steps.

Simple setting of the required torque value without any special tools. Easy-to-read scale value. Rapidaptor quick-release technology for rapid bit change. Unlimited torque to loosen seized screws.

Multi-component Kraftform handle with hard and soft zones for high working speeds, whilst being easy on the hand. Includes 16 bits with a length of 89 mm and a practical pouch for tidy storage.

- Adjustable Kraftform torque screwdriver with Rapidaptor quick-release chuck
- Multi-component Kraftform handle for fast and ergonomic screwdriving
- Rapidaptor technology for rapid bit change
- Suitable for manual and power tool operations
- Practical pouch for tidy storage

### Kraftform Kompakt 60 Torque 1.2 - 3.0 Nm



Code	EAN		
05059293001	169624		1
		7400 1x 7441, 1/4", 1,2-3,0 Nm	
		851/4 Z PH 1x PH 1x89; 1x PH 2x89; 1x PH 3x89 <sup>1)</sup>	
		855/4 Z PZ 1x PZ 1x89; 1x PZ 2x89; 1x PZ 3x89 <sup>1)</sup>	
		867/4 Z TORX® B0 1x TX 10x89; 1x TX 15x89; 1x TX 20x89; 1x TX 25x89; 1x TX 30x89	
		800/4 Z 1x 1,0x5,5x89	
		840/4 Z Hex-Plus 1x 3,0x89; 1x 4,0x89; 1x 5,0x89; 1x 6,0x89 <sup>1)</sup>	

<sup>1)</sup>Hexagonal blade

### Kraftform Stainless - stainless steel to prevent rust

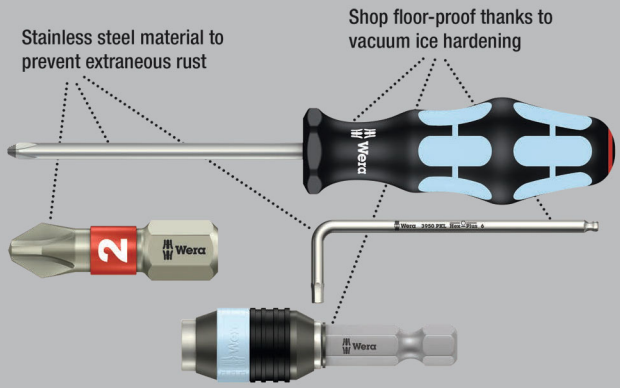

Pouch with bits in a length of 89 mm. Includes Kraftform holder 3816 R with Rapidaptor quick-release chuck and multi-component Kraftform handle for low-fatigue working. Stainless design to prevent the formation of extraneous rust.

### Kraftform Kompakt 60, stainless



Code	EAN		
05071116001	115713		1
		3816 R 1x 1/4"x119	
		3851/4 1x PH 1x89; 1x PH 2x89; 1x PH 3x89 <sup>1)</sup>	
		3855/4 1x PZ 1x89; 1x PZ 2x89; 1x PZ 3x89 <sup>1)</sup>	
		3867/4 TORX® B0 1x TX 10x89; 1x TX 15x89; 1x TX 20x89; 1x TX 25x89; 1x TX 30x89	
		3800/4 1x 1,0x5,5x89	
		3840/4 Hex-Plus 1x 3,0x89; 1x 4,0x89; 1x 5,0x89; 1x 6,0x89	

<sup>1)</sup>Hexagonal blade

### Kraftform Kompakt 60, imperial, stainless



Code	EAN		
05071117001	4013288 115720		1
		<b>3816 R</b> 1x 1/4"x119	
		<b>3851/4 PH</b> 1x PH 1x89; 1x PH 2x89; 1x PH 3x89 <sup>1)</sup>	
		<b>3867/4 TORX® B0</b> 1x TX 10x89; 1x TX 15x89; 1x TX 20x89; 1x TX 25x89; 1x TX 30x89	
		<b>3800/4</b> 1x 1,0x5,5x89	
		<b>3840/4 Hex-Plus</b> 1x 3/32"x89; 1x 1/8"x89; 1x 5/32"x89; 1x 3/16"x89	
		<b>3868/4 Square-Plus</b> 1x # 1x89; 1x # 2x89; 1x # 3x89	

<sup>1)</sup>Hexagonal blade

### Kraftform Kompakt 60

Pouch with 89-mm long bits. Includes 816 R Kraftform holder with Rapidaptor quick-release chuck and multi-component Kraftform handle for low-fatigue working.

Hard gripping zones for high working speeds whereas soft zones ensure high torque transfer. Suitable for manual and power tool operations; 17-piece.

### Kraftform Kompakt 60



Code	EAN		
05059295001	4013288 096289		1
		<b>816 R</b> 1x 1/4"x119	
		<b>851/4 Z</b> 1x PH 1x89; 1x PH 2x89; 1x PH 3x89 <sup>1)</sup>	
		<b>855/4 Z</b> 1x PZ 1x89; 1x PZ 2x89; 1x PZ 3x89 <sup>1)</sup>	
		<b>867/4 Z TORX® B0</b> 1x TX 10x89; 1x TX 15x89; 1x TX 20x89; 1x TX 25x89; 1x TX 30x89	
		<b>800/4 Z</b> 1x 1,0x5,5x89	
		<b>840/4 Z</b> 1x 3,0x89; 1x 4,0x89; 1x 5,0x89; 1x 6,0x89 <sup>1)</sup>	
		<b>Hook and Loop Fastener Strip 70</b> 1x 50,0x70,0	

<sup>1)</sup>Hexagonal blade



## Kraftform Kompakt 60 imperial



Code	EAN		
05051042001	156037		1
		● 816 R 1x 1/4"x119	
		⊕ 851/4 Z 1x PH 1x89; 1x PH 2x89; 1x PH 3x89 <sup>1)</sup>	
		⊗ 867/4 Z TORX® B0 1x TX 10x89; 1x TX 15x89; 1x TX 20x89; 1x TX 25x89; 1x TX 30x89	
		◐ 800/4 Z 1x 1,0x5,5x89	
		○ 840/4 Z 1x 3/32"x89; 1x 1/8"x89; 1x 5/32"x89; 1x 3/16"x89	
		□ 868/4 1x # 1x89; 1x # 2x89; 1x # 3x89	
		Hook and Loop Fastener Strip 70 1x 50,0x70,0	

<sup>1)</sup>Hexagonal blade

## Kraftform Kompakt 60 KK

- Ballpoint bits allow a swivelling of the tool axis

## Kraftform Kompakt 60 KK



Code	EAN		
05059294001	165503		1
		● 816 R 1x 1/4"x119	
		⊕ 851/4 Z 1x PH 1x89; 1x PH 2x89; 1x PH 3x89 <sup>1)</sup>	
		⊕ 855/4 Z 1x PZ 1x89; 1x PZ 2x89; 1x PZ 3x89 <sup>1)</sup>	
		⊗ 867/4 TORX® KK 1x TX 10x89; 1x TX 15x89; 1x TX 20x89; 1x TX 25x89; 1x TX 30x89; 1x TX 40x89 <sup>1)</sup>	
		○ 842/4 1x 3,0x89; 1x 4,0x89; 1x 5,0x89; 1x 6,0x89	
		Hook and Loop Fastener Strip 70 1x 50,0x70,0	

<sup>1)</sup>Hexagonal blade



## Kraftform Kompakt 62



Code	EAN		
05059297001	4013288 096302		1
		● 816 R 1x 1/4"x119	
		+ 851/4 Z 1x PH 1x89; 1x PH 2x89; 1x PH 3x89 <sup>1)</sup>	
		+ 855/4 Z 1x PZ 1x89; 1x PZ 2x89; 1x PZ 3x89 <sup>1)</sup>	
		⊕ 867/4 Z TORX® B0 1x TX 8x89; 1x TX 10x89; 1x TX 15x89; 1x TX 20x89; 1x TX 25x89; 1x TX 27x89; 1x TX 30x89; 1x TX 40x89	
		⊙ 840/4 Z B0 1x 2,0x89; 1x 2,5x89; 1x 3,0x89; 1x 4,0x89; 1x 5,0x89; 1x 6,0x89	
		⊖ 800/4 Z 1x 1,2x6,5x89	
		+ 871/4 TORQ-SET® Mplus 1x 6x89; 1x 8x89; 1x 10x89	
		⤵ 875/4 TRI-WING® 1x 1x89; 1x 2x89; 1x 3x89; 1x 4x89	
		● 857/4 Z 1x 4x89; 1x 6x89; 1x 8x89; 1x 10x89	
		Hook and Loop Fastener Strip 70 1x 50,0x70,0	

<sup>1)</sup>Hexagonal blade

## Bicycle Set 2

Bicycle tool set in practical pouch with 89 mm long bits. Including 816 R Kraftform bit hand-holder with Rapidaptor quick-release chuck and multi-component Kraftform handle for fatigue-free working.

## Bicycle Set 2



Code	EAN		
05004171001	4013288 211439		1
		● 816 R 1x 1/4"x119	
		+ 851/4 Z 1x PH 1x89; 1x PH 2x89	
		⊕ 867/4 Z TORX® 1x TX 10x89; 1x TX 20x89; 1x TX 25x89; 1x TX 30x89	
		⊙ 840/4 Z 1x 2,0x89; 1x 2,5x89; 1x 3,0x89; 1x 4,0x89; 1x 5,0x89; 1x 6,0x89 <sup>1)</sup>	
		Hook and Loop Fastener Strip 70 1x 50,0x70,0	

<sup>1)</sup>Hexagonal blade



## Kraftform Kompakt 70 Universal

32-piece set with 816 R Kraftform bitholding screwdriver with Rapidaptor quick-release chuck and multi-component Kraftform handle for fatigue-free working.

Rapidaptor universal holder with strong permanent magnet, which even holds big and heavy screws. Throw in the 30 bits and the user is equipped for almost every application. In a robust textile box; suitable for Wera 2go.

- Assortment in robust textile box with low weight for easy transport
- Suitable for docking with the Wera 2go system

## Kraftform Kompakt 70 Universal



Code	EAN		
05057113001	4013288 228345		1
		● 816 R 1x 1/4"x119	
		●● 889/4/1 K 1x 1/4"x50	
		⊕ 851/1 TZ 3x PH 1x25; 3x PH 2x25; 3x PH 3x25	
		⊕ 855/1 TZ 3x PZ 1x25; 3x PZ 2x25; 3x PZ 3x25	
		⊕ 867/1 Z TORX® B0 1x TX 10x25; 1x TX 15x25; 1x TX 20x25; 1x TX 25x25; 1x TX 30x25; 1x TX 40x25	
		○ 840/1 Z 1x 4,0x25; 1x 5,0x25; 1x 6,0x25	
		◐ 800/1 TZ 1x 0,6x4,5x25; 1x 1,0x5,5x25; 1x 1,2x6,5x25	
		9478 1x 160,0x95,0x65,0	
		Hook and Loop Fastener Strip 120 1x 50,0x120,0	

## Kraftform Kompakt 71 Security

- Assortment in robust textile box with low weight for easy transport
- Suitable for docking with the Wera 2go system

## Kraftform Kompakt 71 Security



Code	EAN		
05057114001	4013288 228352		1
		● 816 R 1x 1/4"x119	
		●● 889/4/1 K 1x 1/4"x50	
		⊕ 867/1 Z TORX® B0 1x TX 7x25; 1x TX 8x25; 1x TX 9x25; 1x TX 10x25; 1x TX 15x25; 1x TX 20x25; 1x TX 25x25; 1x TX 30x25; 1x TX 40x25	
		○ 840/1 Z B0 1x 2,0x25; 1x 2,5x25; 1x 3,0x25; 1x 4,0x25; 1x 5,0x25; 1x 6,0x25	
		◐ 868/1 Z 1x # 0x25; 1x # 1x25; 1x # 2x25; 1x # 3x25	
		⊕ 871/1 TORQ-SET® Mplus 25 mm 1x 6x25; 1x 8x25; 1x 10x25; 1x 1/4"x25	
		⊕ 875/1 TRI-WING® 25 mm 1x 1x25; 1x 2x25; 1x 3x25	
		● 857/1 Z 1x 4x25; 1x 6x25; 1x 8x25; 1x 10x25	
		9478 1x 160,0x95,0x65,0	
		Hook and Loop Fastener Strip 120 1x 50,0x120,0	

## Kraftform Kompakt 100

52-piece; in surface-protecting, compact textile box which is extremely robust. Low volume and weight for simplified mobility. Compact tool set with 52 screwdriving tools.

1 bit holder Rapidaptor with quick-release chuck; 1 B bit holder Rapidaptor with quick-release chuck for take-up in the power screwdriver or use in the chuck of the power drill; 30 BiTorsion bits with a length of 25 mm for long service life, tough-absorbing (BTZ), for universal use, extra hard (BTH), 12 Impaktor bits with a length of 50 mm for particularly demanding jobs, 8 L-keys with Hex-Plus profile (prevents the rounding of socket head screws) and hexagonal ballpoint on the long arm for working at angles; textile box that is very robust and durable; can be positioned upright for tidy storage on the workshop shelf; additional surface protection thanks to the outer textile material.

- Robust surface-protecting, compact, textile box
- Rapidaptor technology for rapid bit change
- BiTorsion bits in a length of 25 mm for long service life
- Impaktor bits in a length of 50 mm for particularly demanding jobs
- L-keys with Hex-Plus profile (prevents the rounding of hexagon socket screws)

## Hex-Plus - lets hexagon socket screws last longer

Deformation of the screws is reduced

Above-average service life

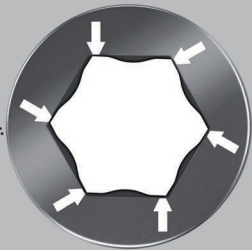

## Kraftform Kompakt 100



Code	EAN		
05057460001	4013288 179968		1
		● 813 R 1x 1/4"x90	
		● 889/4/1 K 1x 1/4"x50	
		⊕ 851/1 BTZ 2x PH 1x25; 4x PH 2x25; 2x PH 3x25	
		⊕ 851/4 Impaktor DC 2x PH 2x50; 1x PH 3x50	
		⊕ 855/1 BTH 2x PZ 1x25; 4x PZ 2x25; 2x PZ 3x25	
		⊕ 855/4 Impaktor DC 2x PZ 2x50; 1x PZ 3x50	
		⊕ 867/1 TORX® BTZ 2x TX 10x25; 2x TX 15x25; 3x TX 20x25; 2x TX 25x25; 2x TX 30x25; 1x TX 40x25	
		⊕ 867/4 TORX® Impaktor DC 1x TX 25x50; 1x TX 30x50; 1x TX 40x50	
		⊖ 800/1 BTZ 1x 0,8x5,5x25; 1x 1,0x5,5x25	
		○ 840/4 Impaktor DC 1x 4,0x50; 1x 5,0x50; 1x 6,0x50	
		○ 950 PKS 1x 1,5x50 <sup>1)</sup> ; 1x 2,0x56; 1x 2,5x63; 1x 3,0x71; 1x 4,0x80; 1x 5,0x90; 1x 6,0x100; 1x 8,0x112	
		Hook and Loop Fastener Strip 120 1x 50,0x120,0	

<sup>1)</sup>Regular hexagon

## Kraftform Kompakt 400

T-handle screwdriver: The ideal handle shape to allow high torque transmission in difficult tightening and loosening situations. The ergonomic shape of the handle fills the palm of the hand well, the fingers lie safely in the soft rounded handle recesses.

The whole hand makes contact with the handle and friction losses between the hand and the handle are avoided. Special surface treatment of the blades for high corrosion protection and an optimum fit in the screw head.

- T-handle screwdriver for the transmission of particularly high tightening and loosening moments
- Ergonomic 2-component handle with finger handle recesses and pleasant surface feel for very high power transmission and fatigue-free working.
- With Rapidaptor technology for lightning-fast bit changes
- Bitholders, magnetic, for easier application of the screw
- For bits with 1/4" external hexagon drive as per DIN ISO 1173-C 6.3 and E 6.3

### Kraftform Kompakt 400

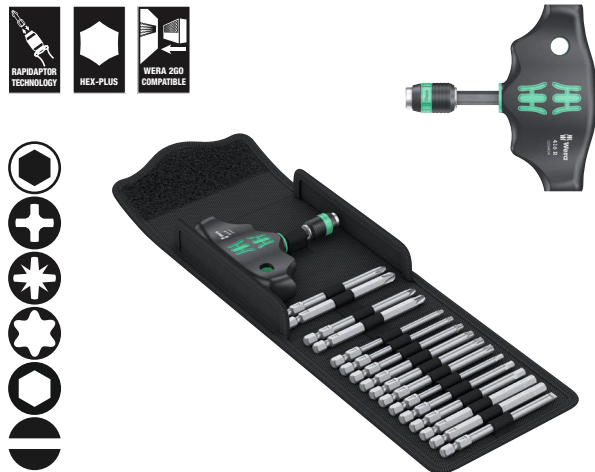

Code	EAN		
05057470001	4013288 214546		1
		<b>416 R</b> 1x 1/4"x45	
		<b>851/4 Z</b> 1x PH 2x89; 1x PH 3x89 <sup>1)</sup>	
		<b>855/4 Z</b> 1x PZ 2x89; 1x PZ 3x89 <sup>1)</sup>	
		<b>867/4 Z TORX®</b> 1x TX 10x89; 1x TX 15x89; 1x TX 20x89; 1x TX 25x89; 1x TX 30x89; 1x TX 40x89	
		<b>840/4 Z</b> 1x 3,0x89; 1x 4,0x89; 1x 5,0x89; 1x 6,0x89; 1x 8,0x89 <sup>1)</sup>	
		<b>800/4 Z</b> 1x 1,0x5,5x89	
		<b>Hook and Loop Fastener Strip 120</b> 1x 50,0x120,0	

<sup>1)</sup>Hexagonal blade

## Kraftform Kompakt 400 RA Set 1

17-piece set in a robust textile box. One 416 RA T-handle bitholding screwdriver with ratchet function and Rapidaptor quick-release chuck for 1/4" bits. The integrated ratchet with fine toothing (80 teeth/return angle 4.5°) eases and accelerates screwdriving without having to reposition the tool. The ratchet mechanism completely embedded in the handle ensures very handy and comfortable work.

With reversing lever for comfortable clockwise/counterclockwise direction change in one-hand operation. The ergonomic shape of the handle fills the ball of the hand well, the fingers lie securely in the softly rounded recessed grips. The whole hand comes into contact with the handle, friction loss between hand and handle is avoided.

Bit holder for bits with 1/4" external hexagon drive as per DIN ISO 1173-C 6.3 and E 6.3. With Rapidaptor technology for lightning-fast bit changes. 16 tough bits, 1/4", 89 mm long, for universal use.

- The integrated ratchet with fine toothing ensures fast and safe working
- Convenient working thanks to the ratchet mechanism fully embedded in the handle
- Rapidaptor bitholding screwdriver with fast-rotating sleeve for lightning-fast bit changes and high working speeds
- Fast-rotating sleeve for extremely high working speed
- Ergonomic 2-component handle with finger handle recesses and pleasant surface feel for very high power transmission and fatigue-free working
- For bits with 1/4" external hexagon drive as per DIN ISO 1173-C 6.3 and E 6.3

### Kraftform Kompakt 400 RA Set 1



Code	EAN		
05023471001	4013288 222879		1
		<b>416 RA</b> 1x 1/4"x45	
		<b>851/4 Z</b> 1x PH 2x89; 1x PH 3x89 <sup>1)</sup>	
		<b>855/4 Z</b> 1x PZ 2x89; 1x PZ 3x89 <sup>1)</sup>	
		<b>867/4 Z TORX®</b> 1x TX 10x89; 1x TX 15x89; 1x TX 20x89; 1x TX 25x89; 1x TX 30x89; 1x TX 40x89	
		<b>840/4 Z</b> 1x 3,0x89; 1x 4,0x89; 1x 5,0x89; 1x 6,0x89 <sup>1)</sup> ; 1x 8,0x89 <sup>1)</sup>	
		<b>800/4 Z</b> 1x 1,0x5,5x89	
		<b>Hook and Loop Fastener Strip 120</b> 1x 50,0x120,0	

<sup>1)</sup>Hexagonal blade

## Kraftform Kompakt 400 RA Imperial Set 1



Code	EAN			
05057473001	4013288 222930			1
		●	<b>416 RA</b> 1x 1/4"x45	
		+	<b>851/4 Z</b> 1x PH 2x89; 1x PH 3x89 <sup>1)</sup>	
		✦	<b>867/4 Z TORX®</b> 1x TX 10x89; 1x TX 15x89; 1x TX 20x89; 1x TX 25x89; 1x TX 30x89; 1x TX 40x89	
		○	<b>840/4 Z</b> 1x 1/8"x89; 1x 5/32"x89; 1x 3/16"x89; 1x 7/32"x89; 1x 1/4"x89	
		□	<b>868/4</b> 1x # 2x89; 1x # 3x89	
		●	<b>800/4 Z</b> 1x 1,0x5,5x89	
			<b>Hook and Loop Fastener Strip 120</b> 1x 50,0x120,0	

<sup>1)</sup>Hexagonal blade

## Kraftform Kompakt 400 RA Set 2

9-piece set in a robust textile box. One 411 A RA T-handle adapter screwdriver with ratchet function for 1/4" sockets.

The integrated ratchet with fine tothing (80 teeth/return angle 4.5°) eases and accelerates screwdriving without having to reposition the tool. The ratchet mechanism completely embedded in the handle ensures very handy and comfortable work.

With reversing lever for comfortable clockwise/counterclockwise direction change in one-hand operation. The ergonomic shape of the handle fills the ball of the hand well, the fingers lie securely in the softly rounded recessed grips.

The whole hand comes into contact with the handle, friction loss between hand and handle is avoided. For 1/4" sockets as well as 1/4" connectors with square head drive, with ball lock. 8 Zyklop sockets with 1/4" drive.

Take it easy tool finder: With colour coding by size – for quick and easy identification of the required tool .

- Ergonomic 2-component handle with finger handle recesses and pleasant surface feel for very high power transmission and fatigue-free working
- The integrated ratchet with fine tothing ensures fast and safe working
- Reversing lever for comfortable clockwise/counterclockwise direction change
- Convenient working thanks to the ratchet mechanism fully embedded in the handle
- Fast-rotating sleeve for extremely high working speed
- 1/4" socket mounting with secure ball lock
- With Take it easy tool finder: colour coding by size



## Kraftform Kompakt 400 RA Set 2



Code	EAN			
05023470001	4013288 222862			1
		○	<b>411 A RA</b> 1x 1/4"x45	
		●	<b>8790 HMA</b> 1x 6,0x23,0; 1x 7,0x23,0; 1x 8,0x23,0; 1x 9,0x23,0; 1x 10,0x23,0; 1x 11,0x23,0; 1x 12,0x23,0; 1x 13,0x23,0	
			<b>Hook and Loop Fastener Strip 120</b> 1x 50,0x120,0	

## Kraftform Kompakt 400 RA Imperial Set 2



Code	EAN		
05057474001	4013288 223364		1
		□ 411 A RA 1x 1/4"x45	
		● 8790 HMA 1x 3/16"x23,0; 1x 7/32"x23,0; 1x 1/4"x23,0; 1x 9/32"x23,0; 1x 5/16"x23,0; 1x 3/8"x23,0; 1x 7/16"x23,0; 1x 1/2"x23,0	
		Hook and Loop Fastener Strip 120 1x 50,0x120,0	

## Kraftform Kompakt 400 RA SHK Set 1

- Set especially for HVAC applications

### Kraftform Kompakt 400 RA SHK Set 1



Code	EAN		
05136072001	4013288 228369		1
		● 416 RA 1x 1/4"x45	
		● 816 R 1x 1/4"x119	
		⊕ 851/4 Z 1x PH 2x89	
		⊕ 855/4 Z 1x PZ 2x89	
		⊕ 855/4 PZ/S 1x # 1x70; 1x # 2x70	
		⊕ 867/4 Z TORX® 1x TX 15x89; 1x TX 20x89; 1x TX 25x89; 1x TX 30x89	
		○ 840/4 Z 1x 2,0x89; 1x 2,5x89; 1x 3,0x89; 1x 4,0x89; 1x 5,0x89; 1x 6,0x89 <sup>1)</sup>	
		● 869/4 M 1x 8,0x50,0; 1x 10,0x50,0	
		Hook and Loop Fastener Strip 120 1x 50,0x120,0	

<sup>1)</sup>Hexagonal blade

### Kraftform Kompakt 900 Set 1

The impact screwdriver 921 combines the advantages of manual impact wrenches, compact tools and screwdrivers with pound-thru blade. The impact wrench function offers a loosening moment of up to 25 Nm.

The robust bit holder allows the mounting of different specialised bits for various screw profiles. The pound-thru blade ensures complete power transmission (zero loss). The impact wrench function and screwdriver function can be switched as required.

- Compact and robust blade screwdriver set with manually activatable impact wrench function
- For loosening stubborn screw connections
- Hammer blow impulse is converted into a rotary movement with a loosening torque of approx. 25 Nm – without loss via a pound-thru blade
- Reversible functions: impact wrench and screwdriver
- Specially hardened and extra tough bits with 1/4" external hexagon drive
- Combines the advantages of manual impact wrenches, compact tools and screwdrivers with pound-thru blade

### Kraftform Kompakt 900 Set 1



Code	EAN			
05018110001	4013288 222176			1
		●	<b>921</b> 1x 1/4"x163,5	
		+	<b>851 S</b> 1x PH 1x70; 1x PH 2x70; 1x PH 3x70	
		+	<b>855 S</b> 1x PZ 1x70; 1x PZ 2x70; 1x PZ 3x70	
		✦	<b>867 S TORX®</b> 1x TX 15x70; 1x TX 20x70; 1x TX 25x70; 1x TX 30x70; 1x TX 40x70	
		○	<b>840 S Hex-Plus</b> 1x 3,0x70; 1x 4,0x70; 1x 5,0x70; 1x 6,0x70	
		◐	<b>800 S</b> 1x 0,8x4,0x70; 1x 1,0x5,5x70; 1x 1,2x6,5x70	
			<b>Hook and Loop Fastener Strip 120</b> 1x 50,0x120,0	

### Kraftform Kompakt 900 Imperial Set 1



Code	EAN			
05018111001	4013288 222312			1
		●	<b>921</b> 1x 1/4"x163,5	
		+	<b>851 S</b> 1x PH 1x70; 1x PH 2x70; 1x PH 3x70	
		✦	<b>867 S TORX®</b> 1x TX 15x70; 1x TX 20x70; 1x TX 25x70; 1x TX 30x70; 1x TX 40x70	
		○	<b>840 S Hex-Plus</b> 1x 1/8"x70; 1x 5/32"x70; 1x 3/16"x70; 1x 1/4"x70	
		○	<b>868 S</b> 1x # 1x70; 1x # 2x70; 1x # 3x70	
		◐	<b>800 S</b> 1x 0,8x4,0x70; 1x 1,0x5,5x70; 1x 1,2x6,5x70	
			<b>Hook and Loop Fastener Strip 120</b> 1x 50,0x120,0	

### 921 Kraffform Plus impact screwdriver - series 900

The impact screwdriver 921 combines the advantages of manual impact wrenches, compact tools and screwdrivers with pound-thru blade. The impact wrench function offers a loosening moment of up to 25 Nm.

The robust bit holder allows the mounting of different specialised bits for various screw profiles. The pound-thru blade ensures complete power transmission (zero loss). The impact wrench function and screwdriver function can be switched as required.

- For loosening stubborn screw connections
- Manual impact wrench function can be switched on and off
- Hammer blow impulse is converted into a rotary movement with a loosening torque of approx. 25 Nm – without loss via a pound-thru blade
- Reversible functions: impact wrench and screwdriver

### 921 Kraffform Plus impact screwdriver - series 900



Code	EAN	Drive	Length (mm)	Length (in)	Weight (kg)	Weight (lb)	Quantity
05018100001	221698	1/4"	163,5	6 7/16"			1

### 851 S Phillips bits for impact screwdrivers

Extra tough bit for Phillips-head screws Phillips-Recess. This prevents the bit from breaking prematurely and extends its service life.

Suitable for use with Wera impact screwdriver 921. With 1/4" hexagonal drive.

- For Phillips screws
- Extra tough for long durability
- 1/4" hexagon drive
- For use with Wera impact screwdriver 921

### 851 S Phillips bits for impact screwdrivers



Code	EAN	Drive	Length (mm)	Length (in)	Weight (kg)	Weight (lb)	Quantity
05018160001	222510	PH 1	70	2 3/4"			5
05018161001	222527	PH 2	70	2 3/4"			5
05018162001	222534	PH 3	70	2 3/4"			5

### 855 S Pozidriv bits for impact screwdrivers

Extra tough bit suitable for Pozidriv screws. This prevents the bit from breaking prematurely and extends its service life.

Suitable for use with Wera impact screwdriver 921. With 1/4" hexagonal drive.

- Suitable for Pozidriv screws
- Extra tough for long durability
- 1/4" hexagon drive
- For use with Wera impact screwdriver 921

### 855 S Pozidriv bits for impact screwdrivers

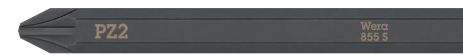

Code	EAN	Drive	Length (mm)	Length (in)	Weight (kg)	Weight (lb)	Quantity
05018163001	222541	PZ 1	70	2 3/4"			5
05018164001	222558	PZ 2	70	2 3/4"			5
05018165001	222565	PZ 3	70	2 3/4"			5

### 867 S TORX® bits for impact screwdrivers

Extra tough bit for TORX® socket screws. This prevents the bit from breaking prematurely and extends its service life.

Suitable for use with Wera impact screwdriver 921. With 1/4" hexagonal drive.

- For recessed TORX® screws
- Extra tough for long durability
- 1/4" hexagon drive
- For use with Wera impact screwdriver 921

### 867 S TORX® bits for impact screwdrivers



Code	EAN	Drive	Length (mm)	Length (in)	Weight (kg)	Weight (lb)	Quantity
05018166001	222572	TX 15	70	2 3/4"			5
05018167001	222589	TX 20	70	2 3/4"			5
05018168001	222596	TX 25	70	2 3/4"			5
05018169001	222602	TX 30	70	2 3/4"			5
05018170001	222619	TX 40	70	2 3/4"			5



## Hex-Plus - lets hexagon socket screws last longer

Deformation of the screws is reduced

Above-average service life

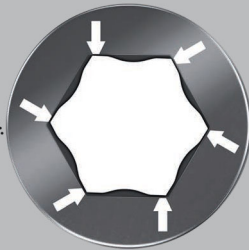

Extra tough bit for hexagonal socket screws. This prevents the bit from breaking prematurely and extends its service life.

Suitable for use with Wera impact screwdrivers 921. With 1/4" hexagonal drive.

- For socket head screws
- Extra tough for long durability
- Hex-Plus allows socket head screws to live longer
- 1/4" hexagon drive
- For use with Wera impact screwdriver 921

### 840 S Hex-Plus bits for impact screwdrivers

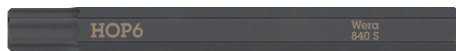

	EAN						
Code	4013288	mm		mm			
05018150001	222428	3,0		70	2 3/4"		5
05018151001	222435	4,0		70	2 3/4"		5
05018152001	222442	5,0		70	2 3/4"		5
05018153001	222459	6,0		70	2 3/4"		5
05018154001	222466		1/8"	70	2 3/4"		5
05018155001	222473		5/32"	70	2 3/4"		5
05018156001	222480		3/16"	70	2 3/4"		5
05018157001	222497		1/4"	70	2 3/4"		5

### 800 S Slotted bits for impact screwdrivers

Extra tough bit for slotted screws. This prevents the bit from breaking prematurely and extends its service life.

Suitable for use with Wera impact screwdriver 921. With 1/4" hexagonal drive.

- For slotted screws
- Extra tough for long durability
- 1/4" hexagon drive
- For use with Wera impact screwdriver 921

### 800 S Slotted bits for impact screwdrivers

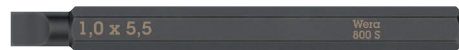

	EAN						
Code	4013288	mm	mm	mm			
05018140001	222398	0,8	4,0	70	2 3/4"		5
05018141001	222404	1,0	5,5	70	2 3/4"		5
05018142001	222411	1,2	6,5	70	2 3/4"		5

### 868 S Square head socket bits for impact screwdrivers

Extra tough bit for square head socket screws. This prevents the bit from breaking prematurely and extends its service life.

Suitable for use with Wera impact screwdriver 921. With 1/4" hexagonal drive.

- Suitable for square head socket screws
- Extra tough for long durability
- 1/4" hexagon drive
- For use with Wera impact screwdriver 921

### 868 S Square head socket bits for impact screwdrivers



	EAN					
Code	4013288		mm			
05018171001	222626	# 1	70	2 3/4"		5
05018172001	222633	# 2	70	2 3/4"		5
05018173001	222640	# 3	70	2 3/4"		5

### Kraftform Kompakt 838 RA S Set 1

14-piece ratchet screwdriver set. Bitholding screwdriver with intuitive ratchet functionality. Turning the tool speeds up work. The ratchet mechanism completely embedded in the handle ensures very handy and effortless work. Ergonomic switching to clockwise/counterclockwise or position 0. Kraftform Plus handle for ergonomic screwdriving, avoiding blisters and calluses. Magnetic bitholding screwdriver for bits with 1/4" external hexagon drive.

13 tough bits for universal use (Phillips-head Phillips and Pozidriv, TORX®, hexagonal socket and slotted), 50 mm length; chemically nickel-plated, some with "Take it easy" Tool finder: With size stamping and colour coding by output to help you find the required bit easily.

- Extremely small bitholding screwdriver for bits with 1/4" external hexagon drive
- Ratchet mechanism integrated in the handle
- The integrated ratchet with fine toothing ensures fast and safe working
- High working speed: The ratchet mechanism allows to "spin" when screwdriving
- Ergonomic intuitive switching to clockwise/counterclockwise or position 0
- Strong permanent magnet in the bit mounting holds the bits firmly
- Take it easy tool finder: colour coding according to profile and size
- Suitable for docking with the Wera 2go system

### Kraftform Kompakt 838 RA S Set 1



Code	EAN		
05051060001	4013288 229755		1
		● <b>838 RA S</b> 1x 1/4"x102	
		⊕ <b>851/4 BTZ</b> 1x PH 1x50; 1x PH 2x50	
		⊕ <b>855/4 BTZ</b> 1x PZ 1x50; 1x PZ 2x50	
		⊕ <b>867/4 TORX® BTZ</b> 1x TX 10x50; 1x TX 15x50; 1x TX 20x50; 1x TX 25x50	
		○ <b>840/4 BTZ</b> 1x 2,5x50; 1x 3,0x50; 1x 4,0x50; 1x 5,0x50	
		◐ <b>800/4 BTZ</b> 1x 0,8x5,5x50	
		<b>Hook and Loop Fastener Strip 70</b> 1x 50,0x70,0	

### Kraftform Kompakt 838 RA S Imperial Set 1



Code	EAN		
05051065001	4013288 229816		1
		● <b>838 RA S</b> 1x 1/4"x102	
		⊕ <b>851/4 BTZ</b> 1x PH 1x50; 1x PH 2x50	
		⊕ <b>867/4 TORX® BTZ</b> 1x TX 10x50; 1x TX 15x50; 1x TX 20x50; 1x TX 25x50	
		○ <b>840/4 Z</b> 1x 3/64"x50; 1x 5/32"x50; 1x 3/16"x50; 1x 7/32"x50	
		◐ <b>800/4 BTZ</b> 1x 0,8x5,5x50	
		◐ <b>868/4</b> 1x # 1x50; 1x # 2x50	
		<b>Hook and Loop Fastener Strip 70</b> 1x 50,0x70,0	

### Kraftform Kompakt 838 RA-R M Set 1

15-piece ratchet screwdriver set. Bitholding screwdriver with intuitive ratchet functionality. The ratchet mechanism with fine toothing integrated in the handle (36 teeth/return angle 10°) eases and accelerates screwdriving without having to reposition the tool. Spinning the tool is also possible. The ratchet mechanism completely embedded in the handle ensures very handy and comfortable work. Ergonomic switching to clockwise/counter-clockwise or position 0.

Kraftform Plus handle for comfortable ergonomic screwdriving, avoiding blisters and calluses. Magnetic bitholding screwdriver for bits with 1/4" external hexagon drive as per DIN ISO 1173-C 6.3 and E 6.3 (ISO 1173).

The Rapidaptor quick-release chuck allows lightning-fast bit changes without any extra tools. The strong permanent magnet holds the bits firmly. 13 tough bits for universal use (Phillips-head Phillips and Pozidriv, TORX®, slotted and hexagonal socket), 89 mm length; chemically nickel-plated.

- Bitholding screwdriver with Rapidaptor quick-release chuck for bits with 1/4" external hexagon drive as per DIN ISO 1173-C 6.3 and E 6.3 and Wera series 1 and 4
- Rapidaptor holder for rapid bit change
- In robust folding pouch with Wera 2go compatibility

### Kraftform Kompakt 838 RA-R M Set 1



Code	EAN		
05051061001	4013288 229779		1
		<b>838 RA-R M</b> 1x 1/4"x123,5	
		<b>851/4 Z</b> 1x PH 1x89; 1x PH 2x89; 1x PH 3x89 <sup>1)</sup>	
		<b>855/4 Z</b> 1x PZ 1x89; 1x PZ 2x89; 1x PZ 3x89 <sup>1)</sup>	
		<b>867/4 Z TORX®</b> 1x TX 10x89; 1x TX 15x89; 1x TX 20x89; 1x TX 25x89	
		<b>840/4 Z</b> 1x 3,0x89; 1x 4,0x89; 1x 5,0x89	
		<b>800/4 Z</b> 1x 1,0x5,5x89	
		<b>Hook and Loop Fastener Strip 70</b> 1x 50,0x70,0	

<sup>1)</sup>Hexagonal blade

### Kraftform Kompakt 838 RA-R M Imperial Set 1



Code	EAN		
05051066001	4013288 229823		1
		<b>838 RA-R M</b> 1x 1/4"x123,5	
		<b>851/4 Z</b> 1x PH 1x89; 1x PH 2x89; 1x PH 3x89 <sup>1)</sup>	
		<b>867/4 Z TORX®</b> 1x TX 10x89; 1x TX 15x89; 1x TX 20x89; 1x TX 25x89	
		<b>840/4 Z</b> 1x 1/8"x89; 1x 5/32"x89; 1x 3/16"x89	
		<b>800/4 Z</b> 1x 1,0x5,5x89	
		<b>868/4</b> 1x # 1x89; 1x # 2x89; 1x # 3x89	
		<b>Hook and Loop Fastener Strip 70</b> 1x 50,0x70,0	

<sup>1)</sup>Hexagonal blade

### Kraftform Kompakt Stubby magazine RA 1

Particularly small bitholding screwdriver with extremely short bit mounting for hard to reach areas. With ratchet function and fine toothing for a low return angle.

Easy-to-operate reversible ring (right, fixed, left). Includes 6 tough, universal bits, which are located in a magazine in the handle. The strong permanent magnet in the bit mounting ensures secure holding of the bit.

The 2-component Kraftform handle with the practical combination of hard and soft zones allows for a firm grip and precise working.

Take it easy tool finder: With size stamping and colour coding by output to help you find the required bit easily.

- Short, compact Stubby shape for working in tight installation spaces, with 6 bits in the integrated magazine
- Ergonomic 2-component Kraftform handle for precise work
- Ratchet function with fine toothing for a low return angle and reversible ring (right, fixed, left)
- Captive and swiveling bit magazine for easy removal and safe storage of bits
- Take it easy tool finder: colour coding according to profile and size

### Kraftform Kompakt Stubby magazine RA 1

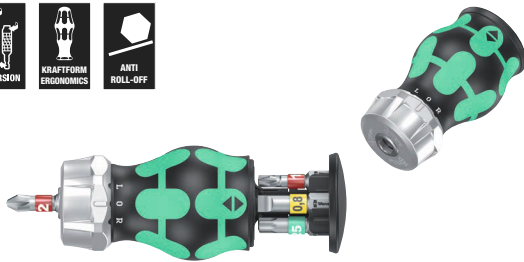

Code	EAN		
05008883001	4013288 221124		1
		⊕ 851/1 BTZ PH 1x PH 1x25; 1x PH 2x25	
		⊗ 867/1 TORX® BTZ 1x TX 15x25; 1x TX 20x25; 1x TX 25x25	
		● 800/1 BTZ 1x 0,8x5,5x25	

† Discontinued item. New version available from 1 June 2025.

### Kraftform Kompakt Stubby magazine RA 2



Code	EAN		
05008884001	4013288 221131		1
		⊕ 851/1 BTZ PH 1x PH 1x25; 1x PH 2x25	
		⊕ 855/1 BTZ PZ 1x PZ 1x25; 1x PZ 2x25	
		⊗ 867/1 TORX® BTZ 1x TX 25x25	
		● 800/1 BTZ 1x 0,8x5,5x25	

† Discontinued item. New version available from 1 June 2025.

### Kraftform Kompakt Stubby magazine RA 4

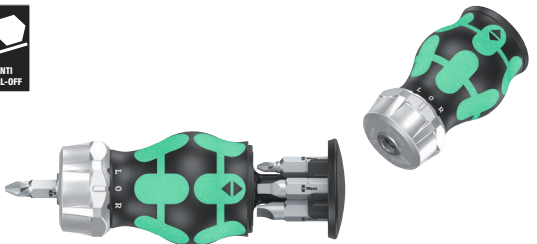

Code	EAN		
05008886001	4013288 221155		1
		⊕ 851/1 Z PH 1x PH 1x25; 1x PH 2x25	
		□ 868/1 Z 1x # 1x25; 1x # 2x25	
		● 800/1 Z 1x 1,0x5,5x25; 1x 1,2x6,5x25	

† Discontinued item. New version available from 1 June 2025.

### Kraftform Kompakt Stubby magazine

Particularly small bitholding screwdriver with short bit mounting for hard to reach areas. Includes 6 bits, which are located in a magazine in the handle.

With only 65mm total length, the Kraftform Kompakt Stubby is a real mini screwdriving workshop. The strong permanent magnet in the bit mounting ensures secure holding of the bit.

The 2-component handle with the practical combination of hard and soft zones allows for a firm grip and precise working. Take it easy tool finder: With size stamping and colour coding by output to find the required bit easily.

- Short, compact Stubby shape for working in tight installation spaces, with 6 bits in the integrated magazine
- Ergonomic 2-component Kraftform handle for precise work
- 1/4" bit mounting with strong permanent magnet
- Captive and swiveling bit magazine for easy removal and safe storage of bits
- Take it easy tool finder: colour coding according to profile and size

### Kraftform Kompakt Stubby magazine 1

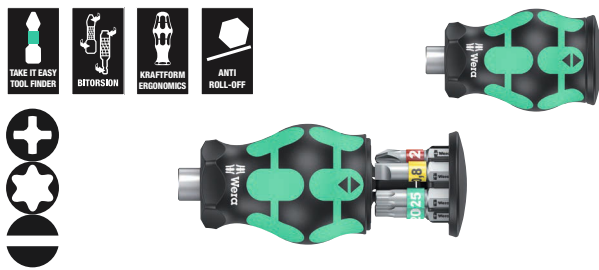

Code	EAN		
05008873001	4013288 217769		1
		+	851/1 BTZ PH 1x PH 1x25; 1x PH 2x25
		⊕	867/1 TORX® BTZ 1x TX 15x25; 1x TX 20x25; 1x TX 25x25
		⊖	800/1 BTZ 1x 0,8x5,5x25

### Kraftform Kompakt Stubby magazine 2

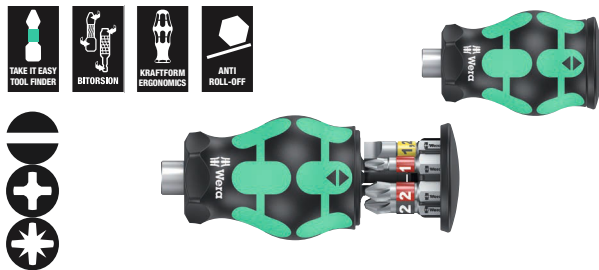

Code	EAN		
05008874001	4013288 217776		1
		⊖	800/1 BTZ 1x 0,8x5,5x25; 1x 1,2x6,5x25
		+	851/1 BTZ PH 1x PH 1x25; 1x PH 2x25
		⊕	855/1 BTZ PZ 1x PZ 1x25; 1x PZ 2x25

### Kraftform Kompakt Stubby magazine 3

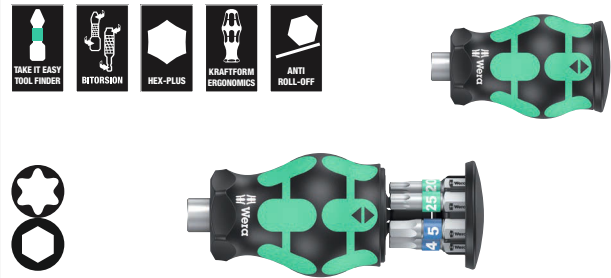

Code	EAN		
05008875001	4013288 217783		1
		⊕	867/1 TORX® BTZ 1x TX 15x25; 1x TX 20x25; 1x TX 25x25
		⊖	840/1 BTZ Hex-Plus 1x 3,0x25; 1x 4,0x25; 1x 5,0x25

### Kraftform Kompakt Stubby magazine 4

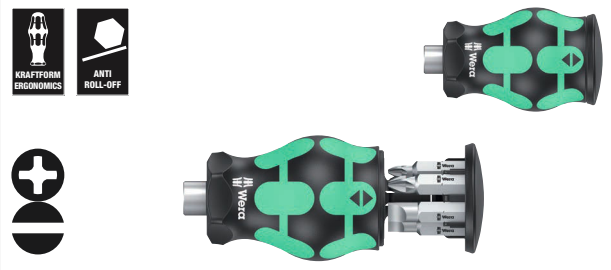

Code	EAN		
05008877001	4013288 219800		1
		+	851/1 Z PH 1x PH 1x25; 1x PH 2x25; 1x PH 3x25
		⊖	800/1 Z 1x 0,6x4,5x25; 1x 1,0x5,5x25; 1x 1,2x6,5x25

### Kraftform Kompakt Stubby magazine 5

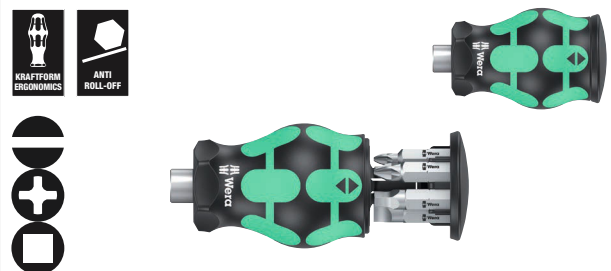

Code	EAN		
05008878001	4013288 219817		1
		⊖	800/1 Z 1x 1,0x5,5x25; 1x 1,2x6,5x25
		+	851/1 Z PH 1x PH 1x25; 1x PH 2x25
		⊖	868/1 Z 1x # 1x25; 1x # 2x25

## Kraftform Kompakt Stubby 1

Handle/interchangeable blade system for lightning fast replacement of the required blade. Especially small bit-holding Stubby screwdriver handle with short blade for hard to reach areas. Suitable for the mounting of bits with 1/4" hexagon drive as per DIN ISO 1173-C 6.3 and Wera connection series 1.

With strong permanent magnet, which also holds large and heavy screws. The 2-component Kraftform handle with its practical combination of hard and soft zones allows for a firm grip and precise working.

High-quality BiTorsion bits with BiTorsion zone to prevent twisting of the bit tip under high loads. This significantly increases product life. Compact, textile box with high robustness, low weight and volume. Suitable for docking with the Wera 2go system.

- Handle/Interchangeable blade system for rapid exchange of the blade
- Stubby bit hand holder: short compact shape for working in confined spaces
- Ergonomic 2-component Kraftform handle for precise work
- Bits with BiTorsion zone to cushion load peaks
- Take it easy tool finder: colour coding according to profile and size

## Kraftform Kompakt Stubby 1



Code	EAN		
	4013288		
05057471001	214553		1
		<b>811/1 Stubby</b> 1x 1/4"	
		<b>851/1 BTZ</b> 1x PH 1x25; 1x PH 2x25	
		<b>855/1 BTZ</b> 1x PZ 1x25; 1x PZ 2x25	
		<b>867/1 TORX® BTZ</b> 1x TX 10x25; 1x TX 15x25; 1x TX 20x25; 1x TX 25x25; 1x TX 30x25	
		<b>840/1 BTZ</b> 1x 2,0x25; 1x 2,5x25; 1x 3,0x25; 1x 4,0x25; 1x 5,0x25; 1x 5,5x25	
		<b>800/1 BTZ</b> 1x 0,8x5,5x25; 1x 1,0x5,5x25; 1x 1,2x6,5x25	
		<b>Hook and Loop Fastener Strip 70</b> 1x 50,0x70,0	

## Bicycle set 11

Stubby magazine for quick operations on the bike. Particularly small bit hand-holder with short bit mounting for hard to reach areas. Includes 7 stainless steel bits, 6 of which are located in a magazine in the handle and one in the bit holder.

The 2-component Kraftform handle with the practical combination of hard and soft zones allows for a firm grip and precise working.

Take it easy tool finder: With size stamping and colour coding by output to help you find the required bit easily.

- Short compact Stubby shape for working in tight installation spaces with 7 included bits
- Ergonomic 2-component Kraftform handle for precise work
- Stainless Steel Bits
- Captive and swiveling bit magazine for easy removal and safe storage of bits
- Take it easy tool finder: colour coding according to profile and size

### Bicycle set 11



Code				EAN			
05004179001				4013288	220714		1
		+	3851/1 TS PH				
		*	3867/1 TS TORX®				
		o	3840/1 TS				
			1x PH 1x25				
			1x TX 10x25; 1x TX 25x25				
			1x 2,5x25; 1x 3,0x25; 1x 4,0x25; 1x 5,0x25				

## Bicycle set 5

Particularly small bitholding screwdriver with extremely short bit mounting for hard to reach areas. With ratchet function and fine toothing for a low return angle.

Easy-to-operate reversible ring (right, tight, left). Includes 7 stainless steel bits, 6 of which are located in a magazine in the handle and one in the bit holder. The strong permanent magnet in the bit mounting ensures secure holding of the bit.

The 2-component Kraftform handle with the practical combination of hard and soft zones allows for a firm grip and precise working.

Take it easy tool finder: With size stamping and colour coding by output to help you find the required bit easily.

- Short compact Stubby shape with magazine for working in tight installation spaces, including 7 stainless steel bits
- Ergonomic 2-component Kraftform handle for precise work
- Ratchet function with fine toothing for a low return angle and reversible ring (right, tight, left)
- Captive and swiveling bit magazine for easy removal and safe storage of bits
- Take it easy tool finder: colour coding according to profile and size

### Bicycle set 5

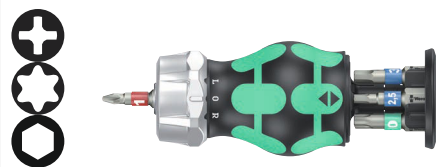
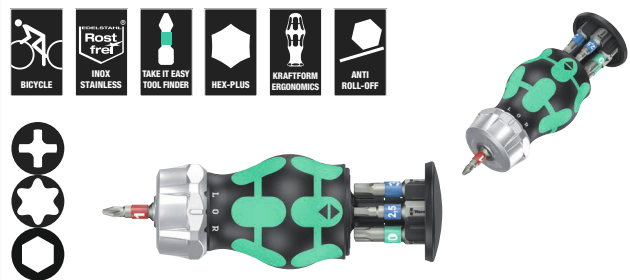

Code				EAN			
05004185001				4013288	221162		1
		+	3851/1 TS PH				
		*	3867/1 TS TORX®				
		o	3840/1 TS				
			1x PH 1x25				
			1x TX 10x25; 1x TX 25x25				
			1x 2,5x25; 1x 3,0x25; 1x 4,0x25; 1x 5,0x25				

<sup>7</sup> Discontinued item. New version available from 1 June 2025.

## Kraftform Kompakt W 1 Maintenance

Compact tool set with the 35 most important screwdriving tools for maintenance work both indoors as well as outdoors.

Includes VDE holder with 12 VDE blades; 1 Joker double open-end wrench with holding function, limit stop, small return angle and extremely gripping teeth; the incredibly fast 1/4" Zyklop Speed ratchet and accessories; 8 manual and power tool sockets, sizes 5.5-13,

1 universal bit holder; 7 bits in a length of 25 mm; 1 screw gripper for firmly holding screws; 1 single-pole phase tester 247; textile box, very robust and durable; can be positioned upright in the workshop shelf for convenient storage; additional surface protection thanks to the textile outer material; low weight and volume for simplified mobility.

- Incredibly fast 1/4" Zyklop Speed ratchet with pivoting ratchet head and 5 predefined locking positions
- Manual and power tool sockets (non-impact) with ball-stop groove and knurling at lower end for more grip
- Joker double open-end wrench with holding function, limit stop, small return angle and extremely gripping teeth
- VDE-insulated Kraftform holder and interchangeable blades
- VDE blades (157 mm length) with practical spinning function, anti-roll protection and "Take it easy" Tool finder: Colour coding by profile and laser-engraved size indication
- Set in robust textile box

## Kraftform Kompakt W 1 Maintenance



Code	EAN		
	4013288		
05135926001	178336		1
		<b>817 VDE</b> 1x 9x98	
		<b>Kraftform Kompakt VDE 60 i Take it easy</b> 1x 0,4x2,5x157	
		<b>Kraftform Kompakt VDE 60 iS Take it easy</b> 1x 0,6x3,5x157; 1x 0,8x4,0x157; 1x 1,0x5,5x157	
		<b>Kraftform Kompakt VDE 62 iS Take it easy</b> 1x PH 1x157; 1x PH 2x157	
		<b>Kraftform Kompakt VDE 65 iS Take it easy</b> 1x PZ 1x157; 1x PZ 2x157	
		<b>Kraftform Kompakt VDE 67 i TORX® Take it easy</b> 1x TX 10x157	
		<b>Kraftform Kompakt VDE 67 iS TORX® Take it easy</b> 1x TX 15x157; 1x TX 20x157; 1x TX 25x157	
		<b>1440</b> 1x 4,5-6,0x41,0	
		<b>247</b> 1x 0,5x3,0x70	
		<b>6002 Joker Double</b> 1x 10x13x167	
		<b>8000 A</b> 1x 1/4"x152,0	
		<b>8784 A1</b> 1x 1/4"x1/4"x37,0	
		<b>8794 SA</b> 1x 1/4"x75,0	
		<b>8790 HMA</b> 1x 5,5x23,0; 1x 6,0x23,0; 1x 7,0x23,0; 1x 8,0x23,0; 1x 10,0x23,0; 1x 11,0x23,0; 1x 12,0x23,0; 1x 13,0x23,0	
		<b>893/4/1 K</b> 1x 1/4"x50	
		<b>855/1 Z</b> 1x PZ 1x25; 1x PZ 2x25	
		<b>840/1 Z</b> 1x 3,0x25; 1x 4,0x25; 1x 5,0x25; 1x 6,0x25	
		<b>867/1 TORX®</b> 1x TX 25x25	
		<b>Hook and Loop Fastener Strip 240</b> 1x 50,0x240,0	

<sup>\*)</sup>Product not available in the USA and Canada.



## Kraftform Kompakt W 2 Maintenance



Code	EAN		
05135870001	4013288 209542		1
		817 VDE 1x 9x98	
		Kraftform Kompakt VDE 60 i Take it easy 1x 0,4x2,5x157	
		Kraftform Kompakt VDE 60 iS Take it easy 1x 0,6x3,5x157; 1x 0,8x4,0x157; 1x 1,0x5,5x157	
		Kraftform Kompakt VDE 62 iS Take it easy 1x PH 1x157; 1x PH 2x157	
		Kraftform Kompakt VDE 67 i TORX® Take it easy 1x TX 10x157	
		Kraftform Kompakt VDE 67 iS TORX® Take it easy 1x TX 15x157; 1x TX 20x157; 1x TX 25x157	
		Kraftform Kompakt VDE 65 iS Take it easy 1x PZ 1x157; 1x PZ 2x157	
		1440 1x 4,5-6,0x41,0	
		335 1x 0,4x2,5x60 <sup>1)</sup>	
		6002 Joker Double 1x 10x13x167	
		8000 A 1x 1/4"x152,0	
		8784 A1 1x 1/4"x1/4"x37,0	
		8794 SA 1x 1/4"x75,0	
		8790 HMA 1x 5,5x23,0; 1x 6,0x23,0; 1x 7,0x23,0; 1x 8,0x23,0; 1x 10,0x23,0; 1x 11,0x23,0; 1x 12,0x23,0; 1x 13,0x23,0	
		893/4/1 K 1x 1/4"x50	
		851/1 Z 1x PH 1x25; 1x PH 2x25	
		840/1 Z 1x 3,0x25; 1x 4,0x25; 1x 5,0x25; 1x 6,0x25	
		867/1 TORX® 1x TX 25x25	
		Hook and Loop Fastener Strip 240 1x 50,0x240,0	

<sup>1)</sup>without Lasertip

## Kraftform Kompakt W Imperial 1 Maintenance



Code	EAN		
05135871001	4013288 209559		1
		817 VDE 1x 9x98	
		Kraftform Kompakt VDE 60 i Take it easy 1x 0,4x2,5x157	
		Kraftform Kompakt VDE 60 iS Take it easy 1x 0,6x3,5x157; 1x 0,8x4,0x157; 1x 1,0x5,5x157	
		Kraftform Kompakt VDE 62 iS Take it easy 1x PH 1x157; 1x PH 2x157	
		Kraftform Kompakt VDE 67 i TORX® Take it easy 1x TX 10x157	
		Kraftform Kompakt VDE 67 iS TORX® Take it easy 1x TX 15x157; 1x TX 20x157; 1x TX 25x157	
		Kraftform Kompakt VDE 68 iS Take it easy 1x # 1x157; 1x # 2x157	
		335 1x 0,4x2,5x60 <sup>1)</sup>	
		1440 1x 4,5-6,0x41,0	
		6000 Joker Imperial 1x 1/2"x177	
		8000 A 1x 1/4"x152,0	
		8790 HMA 1x 7/32"x23,0; 1x 1/4"x23,0; 1x 9/32"x23,0; 1x 5/16"x23,0; 1x 3/8"x23,0; 1x 7/16"x23,0; 1x 1/2"x23,0; 1x 9/16"x23,0	
		8784 A1 1x 1/4"x1/4"x37,0	
		8794 SA 1x 1/4"x75,0	
		893/4/1 K 1x 1/4"x50	
		851/1 Z 1x PH 1x25; 1x PH 2x25	
		840/1 Z 1x 1/8"x25; 1x 5/32"x25; 1x 7/32"x25; 1x 1/4"x25	
		867/1 TORX® 1x TX 25x25	
		Hook and Loop Fastener Strip 240 1x 50,0x240,0	

<sup>1)</sup>without Lasertip

## Kraftform Kompakt H 1 Woodcraft

Compact tool set with the 41 most important screwdriving tools for applications involving wood. Includes the bit ratchet Zyklop Mini with extension and socket adaptor; 8 manual and power tool sockets, sizes 5.5-13, 1 ratchet holder 816 RA with ratcheting function, fine-pitched teeth for small return angle, switchover ring (right, fixed, left), maximum torque 50 Nm and bit take-up with the Rapidaptor technology; 1 universal bit holder; 6 bits in a length of 25 mm; 16 bits of a length of 89 mm; 5 wood twist drill bits with a diameter of 3-8 mm; 1 screw gripper for firmly holding screws; 1 single-pole phase tester 247; textile box, very robust and durable; can be positioned upright in the workshop shelf for convenient storage; additional surface protection thanks to the textile outer material; low weight and volume for simplified mobility.

- Robust Zyklop Mini ratchet suitable for take-up of bits and sockets
- Torque of over 65 Nm thanks to fine-pitched ratchet mechanism and small return angle of 6°
- Ratcheting screwdriver with Rapidaptor technology for rapid bit change
- High quality wood twist drill bits for drilling soft wood, hard wood and laminated panel material
- Set in robust textile box

## Kraftform Kompakt H 1 Woodcraft



Code	EAN		
05135939001	4013288 178350		1
		● 816 RA 1x 1/4"x142,0	
		● 8001 A 1x 1/4"x87,0	
		○ 870/1 1x 1/4"x25 <sup>1)</sup>	
		● 8794 SA 1x 1/4"x75,0	
		● 8790 HMA 1x 5,5x23,0; 1x 6,0x23,0; 1x 7,0x23,0; 1x 8,0x23,0; 1x 10,0x23,0; 1x 12,0x23,0; 1x 13,0x23,0	
		● 893/4/1 K 1x 1/4"x50	
		⊕ 851/4 Z PH 1x PH 1x89; 1x PH 2x89; 1x PH 3x89 <sup>2)</sup>	
		⊕ 855/4 Z PZ 1x PZ 1x89; 1x PZ 2x89; 1x PZ 3x89 <sup>2)</sup>	
		⊕ 855/1 Z PZ 1x PZ 1x25; 1x PZ 2x25; 1x PZ 3x25	
		⊕ 867/4 Z TORX® BO 1x TX 10x89; 1x TX 15x89; 1x TX 20x89; 1x TX 25x89; 1x TX 30x89	
		⊕ 867/1 TORX® 1x TX 20x25; 1x TX 25x25	
		○ 840/4 Z Hex-Plus 1x 3,0x89; 1x 4,0x89; 1x 5,0x89; 1x 6,0x89 <sup>2)</sup>	
		● 800/4 Z 1x 1,0x5,5x89	
		● 800/1 Z 1x 1,0x5,5x25	
		⊗ 849 HSS 1x 3,0x70,0; 1x 4,0x74,0; 1x 5,0x85,0; 1x 6,0x95,0; 1x 8,0x110,0	
		● 247 1x 0,5x3,0x70	
		1441 1x 4,5 - 6,0x41,0	

<sup>1)</sup> With friction ball; for manual nut spinner sockets

<sup>2)</sup> Hexagonal blade

<sup>3)</sup> Product not available in the USA and Canada.















## Kraftform Kompakt M 1 Metal

Compact tool set with the 39 most important screwdriving tools for jobs on metal. Includes the incredibly fast 1/4" Zyklop Speed ratchet and accessories; 7 manual and power tool sockets, sizes 5.5-13, 1 universal bit holder;

13 bits in a length of 89 mm; 6 metal twist drill bits with diameter of 3-10 mm; 1 screw gripper for firmly holding screws; 1 single-pole phase tester 247; textile box, very robust and durable; can be positioned upright in the workshop shelf for convenient storage; additional surface protection thanks to the textile outer material; low weight and volume for simplified mobility.

## Kraftform Kompakt M 1 Metal



Code	EAN		
05135928001	4013288 178367		 1
		<b>8000 A</b> 1x 1/4"x152,0	
		<b>8794 LA</b> 1x 1/4"x150,0	
		<b>8794 A</b> 1x 1/4"x56,0	
		<b>8784 A1</b> 1x 1/4"x1/4"x37,0	
		<b>816 R</b> 1x 1/4"x119	
		<b>8790 HMA</b> 1x 5,5x23,0; 1x 6,0x23,0; 1x 7,0x23,0; 1x 8,0x23,0; 1x 10,0x23,0; 1x 12,0x23,0; 1x 13,0x23,0	
		<b>851/4 Z PH</b> 1x PH 1x89; 1x PH 2x89; 1x PH 3x89 <sup>1)</sup>	
		<b>840/4 Z Hex-Plus</b> 1x 3,0x89; 1x 4,0x89; 1x 5,0x89; 1x 6,0x89 <sup>1)</sup>	
		<b>867/4 Z TORX®</b> 1x TX 10x89; 1x TX 15x89; 1x TX 20x89; 1x TX 25x89; 1x TX 30x89	
		<b>800/4 Z</b> 1x 1,0x5,5x89	
		<b>847 HSS</b> 1x 2,5x36,0; 1x 3,3x39,0; 1x 4,2x41,0; 1x 5,0x44,0; 1x 6,8x51,0; 1x 8,5x59,0	
		<b>848 HSS</b> 1x 3,0x38,0; 1x 4,0x44,0; 1x 5,0x50,0; 1x 6,0x50,0; 1x 8,0x51,0; 1x 10,0x54,0	
		<b>1441</b> 1x 4,5 - 6,0x41,0	
		<b>247</b> 1x 0,5x3,0x70	

<sup>1)</sup> Hexagonal blade

<sup>2)</sup> Product not available in the USA and Canada.



## Kraftform Kompakt SH 1 PlumbKit

Compact tool set with the 25 most important screwdriving tools for plumbing and heating applications. Includes 2 Joker open-end wrenches, the 1/4" Zyklop ratchet and accessories, 6 x 89 mm bits, 5 multi-component Kraftform Plus screwdrivers and single-pole phase tester. Two Joker combination ratcheting wrenches with special holding plate against slipping/loss of the screw and more torque transfer; 1 Zyklop ratchet 8000 A (1/4") for fast, powerful working; 3 Zyklop sockets 8790 HMA for manual and power tools usage; 1 Zyklop adaptor 8784 A1 for bits; 6 TORX® HF bits 867/4 with holding function for TORX® screws for secure carry without any loss of the screws;

1 single-pole phase tester 247; 2 Kraftform series 100 slotted screwdrivers 160 i and 160 iS for safe work up to 1,000 volts (160 iS with reduced shaft diameter and integrated insulation protection for reaching and actuating low-lying screws and spring elements);













1 Kraftform Chiseldriver 932 A (slotted) with hex blade extending right through the handle and integrated impact cap for screwdriving and simpler chiselling work; 2 nutsetters 395 HO with hollow shaft for the tightening or loosening of screws on long bolts as well as seized screws.

Take it easy tool finder with colour coding according to profiles and size stamp – for simple and rapid accessing of the required tool.

- Joker combination ratcheting wrench with special holding plate against slipping/loss of the screw
- Zyklop Speed ratchet for fast and powerful working
- Insulated Kraftform VDE slotted screwdriver for safe work at 1,000 volts
- Kraftform Chiseldriver with hex blade extending through handle and integrated impact cap
- Hollow shaft nutspinner for nuts on protruding threaded rods

## Kraftform Kompakt SH 1 PlumbKit



Code	EAN		
	4013288		
05135927001	170132		1
		<b>6000 Joker</b> 1x 10x159; 1x 13x177	
		<b>8000 A</b> 1x 1/4"x152,0	
		<b>8790 HMA</b> 1x 7,0x23,0; 1x 10,0x23,0; 1x 13,0x23,0	
		<b>8784 A1</b> 1x 1/4"x1/4"x37,0	
		<b>867/4 TORX® HF</b> 2x TX 20x50; 2x TX 25x50; 1x TX 30x50; 1x TX 40x50 <sup>1)</sup>	
		<b>851/4 Z PH</b> 1x PH 1x89; 1x PH 2x89	
		<b>840/4 Z Hex-Plus</b> 1x 3,0x89; 1x 4,0x89; 1x 5,0x89; 1x 6,0x89 <sup>2)</sup>	
		<b>247</b> 1x 0,5x3,0x70	
		<b>160 iS</b> 1x 0,6x3,5x100	
		<b>160 i VDE</b> 1x 1,0x5,5x125	
		<b>932 A</b> 1x 1,2x7,0x125	
		<b>395 HO</b> 1x 10,0x90; 1x 13,0x90	

<sup>1)</sup> Product not available in the USA and Canada.

<sup>1)</sup> Pound-thru hexagonal; no Take it easy.

<sup>2)</sup> Hexagonal blade

## Kraftform Kompakt SH 2 PlumbKit

- 15 screwdriving tools for sanitary or heating applications in compact and robust Wera textile box
- Joker combination ratcheting wrench with special holding plate against slipping/loss of the screw
- Insulated Kraftform VDE slotted screwdriver for safe work at 1,000 volts
- Kraftform Chiseldriver with hex blade extending through handle and integrated impact cap
- Hollow shaft nutspinner for nuts on protruding threaded rods
- VDE-insulated Kraftform holder and interchangeable blades
- VDE blades (157 mm length) with practical spinning function, anti-roll protection and "Take it easy" Tool finder: Colour coding by profile and laser-engraved size indication

### Kraftform Kompakt SH 2 PlumbKit



Code	EAN			
05136026001	204387			1
		●	<b>395 H0</b> 1x 10,0x90; 1x 13,0x90	
		●	<b>932 A</b> 1x 1,2x7,0x125	
			<b>6001 Joker Switch</b> 1x 10x159; 1x 13x179	
		○	<b>950 SPKL HF Multicolour</b> 1x 3,0x123; 1x 4,0x137; 1x 5,0x154; 1x 6,0x172	
		●	<b>817 VDE</b> 1x 9x98	
		+	<b>Kraftform Kompakt VDE 62 iS Take it easy</b> 1x PH 1x157; 1x PH 2x157	
		—	<b>Kraftform Kompakt VDE 60 iS Take it easy</b> 1x 0,6x3,5x157; 1x 1,0x5,5x157	
		●	<b>247</b> 1x 0,5x3,0x70	
			<b>Hook and Loop Fastener Strip 240</b> 1x 50,0x240,0	

<sup>1)</sup>Product not available in the USA and Canada.

## Kraftform Kompakt F 1 screwdriving tool set for window installation

Compact Wera screwdriving tool set with the 36 most important tools for window construction

- Premium 36-piece universal tool set for the professional window builder
- 393 S extra slim bit hand holder with flexible shaft for applications in hard-to-reach work spaces
- Socket wrench and bit assortment in premium Wera quality, attuned to universal window construction applications
- Compact and solid textile tool box with Wera 2go compatibility

### Kraftform Kompakt F 1 screwdriving tool set for window installation

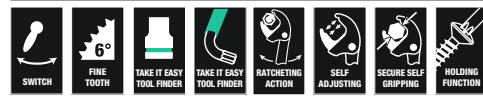

Code	EAN			
05134013001	217721			1
		●	<b>393 S</b> 1x 1/4"x173,5	
		●	<b>813</b> 1x 1/4"x78	
		○	<b>8001 A</b> 1x 1/4"x87,0	
		○	<b>870/1</b> 1x 1/4"x25 <sup>1)</sup>	
		○	<b>8794 SA</b> 1x 1/4"x75,0	
		○	<b>8790 HMA</b> 1x 7,0x23,0; 1x 8,0x23,0; 1x 10,0x23,0; 1x 13,0x23,0	
		+	<b>851/4 TZ PH</b> 1x PH 1x50; 1x PH 2x50; 1x PH 3x50	
		+	<b>867/4 Z TORX®</b> 1x TX 8x50; 1x TX 10x50; 1x TX 15x50; 1x TX 20x50; 1x TX 25x50; 1x TX 30x50	
		○	<b>840/4 Z Hex-Plus</b> 1x 2,0x50; 1x 2,5x50; 1x 3,0x50; 1x 4,0x50; 1x 5,0x50; 1x 6,0x89 <sup>2)</sup>	
		○	<b>950 SPKL Multicolour</b> 1x 2,0x101; 1x 2,5x112	
		○	<b>950 SPKL HF Multicolour</b> 1x 3,0x123; 1x 4,0x137; 1x 5,0x154	
		+	<b>967 SXL HF TORX® Multicolour</b> 1x TX 8x90; 1x TX 10x112; 1x TX 15x123; 1x TX 20x137; 1x TX 25x154; 1x TX 30x195	
			<b>6004 Joker S</b> 1x 10-13 (1/16"-1/2")x154	

<sup>1)</sup> With friction ball; for manual nut spinner sockets

<sup>2)</sup> Hexagonal blade

## 9532 Chain riveter set for workshops

18-piece tool set for the bike workshop. With the Zyklop Mini bit ratchet and the bitholding screwdriver and the 89 mm and 25 mm length bits, hexagonal socket, TORX® and Phillips-head Phillips screws can be operated.

With the included chain riveter and chain fastener with exchangeable rivet pin, bicycle chains can be opened and closed (suitable for single-speed chains, up to 12-speed). The chain lock tool makes it easier to open and close chains with a chain lock.

- Tool set for the bike workshop
- With Wera Zyklop Mini 1 bit ratchet, 816 R bitholding screwdriver, one chain riveter, one chain fastener, spare parts set chain riveter pin, one chain lock tool, 10 bits with 89 mm length, 2 bits with 25 mm length
- With chain riveter and chain fastener with exchangeable rivet pin for opening and closing bicycle chains. Suitable for single-speed chains, up to 12-speed
- Quick-release bike chain tool for opening and closing chains with a chain lock
- In robust pouch

## 9532 Chain riveter set for workshops



Code	EAN			
05136042001	229571			1
		●	<b>8001 A</b> 1x 1/4"x87,0	
		●	<b>816 R</b> 1x 1/4"x119	
		+	<b>851/4 Z</b> 1x PH 1x89; 1x PH 2x89	
		⊕	<b>867/4 Z TORX®</b> 1x TX 10x89; 1x TX 25x89	
		○	<b>840/4 Z</b> 1x 2,0x89; 1x 2,5x89; 1x 3,0x89; 1x 4,0x89; 1x 5,0x89; 1x 6,0x89 <sup>1)</sup>	
		○	<b>840/1 Z</b> 1x 5,0x25; 1x 8,0x25	
			<b>9512 Chain-Hook</b>	
			<b>9513 Chain Tool</b>	
			<b>9533 Quick-release bike chain tool</b> 1x 167,5	
			<b>9534</b> 3x 15,0	

<sup>1)</sup>Hexagonal blade

## 9100 guitar tool set

Guitar tool set: The set contains all the tools necessary for adjustment and maintenance repair work. Wera stainless steel angle wrench with Hex-Plus profile (sizes: 1.5, 2.0, 2.5, 5.0 and in the inch sizes 1/8", 5/32", 3/16").

Wera 89 mm long stainless steel bits for hexagon socket screws (sizes: 1.5, 2.0, 2.5), Kraftform handle for 1/4" bits, 1/4" stainless steel bits for slot (sizes: 1.8x12x41 mm, 0.6x3.5x89 mm, 1.2x8.0x89 mm), Phillips screws (sizes: PH 1x89 mm, PH 2x89 mm) and hexagon socket screws (size: 0.05"x25 mm), Wera adapter for handle (1/4" hex socket of the handle on 1/4" square of sockets), Wera Zyklop sockets (sizes 10 and 1/2"), string crank with 1/4" hex for use in the handle, Knipex® string cutter, feeler gauge, input jacker, 2 picks.

## 9100 guitar tool set



Code	EAN			
05134015001	211675			1
		●	<b>815 R</b> 1x 1/4"x119	
		+	<b>3851/4</b> 1x PH 1x89; 1x PH 2x89	
		●	<b>3800/1 TS</b> 1x 1,8x12,0x41	
		●	<b>3800/4</b> 1x 0,6x3,5x89; 1x 1,2x8,0x89	
		○	<b>3840/1 TS</b> 1x 0,05"x25	
		○	<b>3950 PKL</b> 1x 1,5x90; 1x 2,0x101; 1x 2,5x112; 1x 3,0x123; 1x 4,0x137; 1x 5,0x154	
		○	<b>3950 PKL Imperial</b> 1x 1/8"x123; 1x 5/32"x137; 1x 3/16"x154	
		○	<b>870/1</b> 1x 1/4"x25 <sup>1)</sup>	
		●	<b>8790 HMA</b> 1x 10,0x23,0; 1x 7/16"x23,0	
		●	<b>8790 HMA Deep</b> 1x 1/2"x50,0	
			<b>9103 stringer</b>	
			<b>9105 slip gauge 0,05 - 1,00mm, 13 blades</b>	
			<b>9104 Input-Jacker</b>	
			<b>9101 plectrum Wera</b>	
			<b>9102 plectrum Tool Rebel</b>	
			<b>9110 box with lid Wera</b>	
			<b>KNIPEX® 74 01 140</b>	
			<b>Hook and Loop Fastener Strip 120</b> 1x 50,0x120,0	

<sup>1)</sup>With friction ball; for manual nut spinner sockets

### 838 RA-R M Bitholding screwdriver with ratchet functionality, 1/4"

Premium bitholding screwdriver. Kraftform Plus handle for comfortable ergonomic screwdriving, avoiding blisters and calluses. Hard handle zones for high working speeds, while soft handle zones guarantee a high torque transfer.

Suitable for bits with 1/4" external hexagon drive as per DIN ISO 1173-C 6.3.

- Bitholding screwdriver with Rapidaptor quick-release chuck for bits with 1/4" external hexagon drive as per DIN ISO 1173-C 6.3 and E 6.3 and Wera series 1 and 4
- Ratchet mechanism integrated in the handle
- The integrated ratchet with fine toothing ensures fast and safe working
- High working speed: The ratchet mechanism allows to "spin" when screwdriving
- Ergonomic intuitive switching to clockwise/counterclockwise or position 0
- Rapidaptor holder for rapid bit change
- For bits with 1/4" external hexagon drive as per DIN ISO 1173-C 6.3 and E 6.3
- Multi-component Kraftform handle for fast and ergonomic screwdriving
- Hexagonal anti-roll feature against rolling away
- Magnetic

### 838 RA-R M Bitholding screwdriver with ratchet functionality, 1/4"



Code	EAN	Hexagon Drive	Length	Width	Weight	Volume	Unit
05051493001	229748	1/4"	123,5	98			1

### 838 RA S Bitholding screwdriver with ratchet functionality, 1/4"

Premium bitholding screwdriver. Kraftform Plus handle for comfortable ergonomic screwdriving, avoiding blisters and calluses. Hard handle zones for high working speeds, while soft handle zones guarantee a high torque transfer.

Suitable for bits with 1/4" external hexagon drive as per DIN ISO 1173-C 6.3.

- Extremely small bitholding screwdriver for bits with 1/4" external hexagon drive
- Ratchet mechanism integrated in the handle
- The integrated ratchet with fine toothing ensures fast and safe working
- High working speed: The ratchet mechanism allows to "spin" when screwdriving
- Ergonomic intuitive switching to clockwise/counterclockwise or position 0
- Strong permanent magnet in the bit mounting holds the bits firmly
- Universal holder for the take-up of bits with 1/4" hexagon head drive
- Multi-component Kraftform handle for fast and ergonomic screwdriving
- Magnetic

### 838 RA S Bitholding screwdriver with ratchet functionality, 1/4"



Code	EAN	Hexagon Drive	Length	Width	Weight	Volume	Unit
05051492001	229731	1/4"	102	84			1



## Radidaptor - the amazing compact multifunction tool



High quality holder for stainless steel bits so as to avoid the formation of extraneous rust. The Radidaptor quick-release chuck enables rapid bit change without needing any special tools.

Kraftform Plus handle for pleasant, ergonomic working that makes blisters and calluses a thing of the past. Hard gripping zones for high working speeds whereas soft zones ensure high torque transfer.

Suitable for bits with 1/4" hexagon head drive as per DIN ISO 1173-C 6.3 and E 6.3 (ISO 1173).

- Solution to the extraneous rust problem: fasten stainless screws with stainless tools
- Bit handholder with Radidaptor quick-release chuck, stainless
- Secure clamping of bits
- Fast bit change
- Free-turning sleeve for guiding the power tool

## Kraftform Stainless - stainless steel to prevent rust

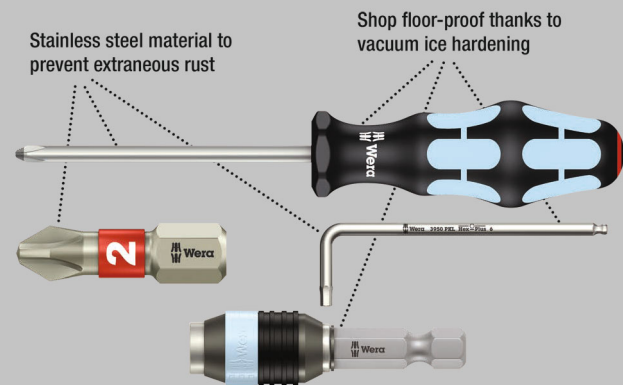

## 3816 R Bit-holding screwdriver with Radidaptor quick-release chuck, stainless



	EAN							
Code	4013288		mm					
05051465001	127570	1/4"	119					5

## 817 R Bitholding screwdriver with Radidaptor quick-release chuck

High quality bit holder. The telescopic bayonet blade, which can be lowered into the handle, together with the quick-release chuck allows fast manual work even in confined installation situations. The Radidaptor quick-release chuck enables rapid bit change without needing any special tools.

The strong permanent magnet holds the bits absolutely securely. Kraftform Plus handle for pleasant, ergonomic working that makes blisters and calluses a thing of the past. Hard gripping zones for high working speeds whereas soft zones ensure high torque transfer. Suitable for bits with 1/4" hexagon head drive as per DIN ISO 1173-C 6.3 and E 6.3 (ISO 1173).

- Retractable bayonet blade

## 817 R Bitholding screwdriver with Radidaptor quick-release chuck

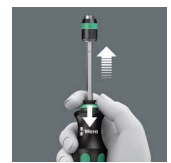

	EAN							
Code	4013288		mm					
05051482001	103130	1/4"	133					2

## 817 R SB Bitholding screwdriver with Radidaptor quick-release chuck

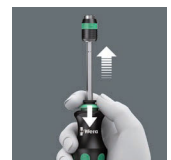

	EAN							
Code	4013288							
05073541001	106025		817 R				1x 1/4"x133	1



### 816 R Bitholding screwdriver with Rapidaptor quick-release chuck



	EAN							
Code	4013288		mm					
05051462001	099617	1/4"	119					5

### 816 R SB Bitholding screwdriver with Rapidaptor quick-release chuck

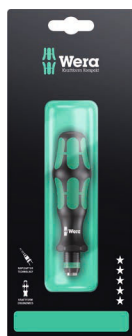

	EAN							
Code	4013288							
05073540001	106032		816 R					1
			1x 1/4"x119					

### 813 R Bitholding screwdriver with Rapidaptor quick-release chuck



	EAN							
Code	4013288		mm					
05051272001	103123	1/4"	90					2

### 393 S Bitholding screwdriver extra slim with flexible shaft

Screwdriver with bendable shaft to reach hard-to-reach areas. Thanks to the construction with a particularly slim bit holder, different screw profiles can be operated, even in very narrow work spaces. Multi-component Kraftform handle for high work speed and especially ergonomic screwdriving. With hexagon anti-roll protection to avoid rolling away.

- Flexible, bendable shaft
- Secure bit holding feature due to locking mechanism. With strong permanent magnet.
- Compact stainless steel holder for bits with 1/4"- external hexagon drive as per DIN 3126, ISO 1173 Form C 6.3 and E 6,3
- Multi-component Kraftform handle for fast and ergonomic screw-driving

### 393 S Bitholding screwdriver extra slim with flexible shaft



	EAN							
Code	4013288		mm	mm				
05028161001	217660	1/4"	173,5	98	6 53/64"			5

### 392 Bitholding screwdriver with flexible shaft

High quality bit holder with flexible shaft by Wera. Multi-component Kraftform handle for high working speeds and particularly ergonomic screwdriving.

Kraftform Plus: hard gripping zones for high working speeds whereas soft zones ensure high torque transfer. Comes with quick-release chuck for rapid bit change and hexagonal anti-roll feature that prevents any rolling away. Suitable for the insertion of bits with 1/4" hexagon head drive as per DIN ISO 1173-C 6.3.

- Bit holder with flexible shaft and quick-release chuck
- Flexible, circular blade

### 392 Bitholding screwdriver with flexible shaft



	EAN							
Code	4013288		mm	mm				
05028160001	041418	1/4"	177	98	7"			5

### 813 Bitholding screwdriver

- Bit holder for bits with 1/4" hexagon drive
- Magnetic

#### 813 Bitholding screwdriver



	EAN					
Code	4013288		mm	mm		
05051274001	175656	1/4"	78	68		3

### 812/1 Bitholding screwdriver with strong permanent magnet

- Hexagonal blade, chrome-plated
- Stainless sleeve with strong permanent magnet for secure fit of the bit

#### 812/1 Bitholding screwdriver with strong permanent magnet



	EAN						
Code	4013288		mm	mm	mm		
05051205001	012272	1/4"	120	112	10,5	4 3/4"	2

### 811/1 Stubby bits hand holder, magnetic

Especially small bit-holding Stubby screwdriver handle with short blade for hard to reach areas. Suitable for the mounting of bits with 1/4" hexagon drive as per DIN ISO 1173-C 6.3 and Wera connection series 1. With strong permanent magnet, which also holds large and heavy screws.

The 2-component Kraftform handle with its practical combination of hard and soft zones allows for a firm grip and precise working.

The hexagon anti-roll protection prevents annoying rolling away of bits in the workplace.

- Short compact shape for working in confined spaces
- Ergonomic 2-component Kraftform handle for precise work
- Hexagonal anti-roll feature against rolling away
- Magnetic bits hand holder for easier placement of the screws
- For 1/4" bits as per DIN ISO 1173-C 6.3

### 811/1 Stubby bits hand holder, magnetic



	EAN						
Code	4013288		mm	mm			
05008880001	212375	1/4"	10	54	3/8"		2

### 810/1 Bitholding screwdriver with retaining ring

- Bit holder with retaining ring for bits with 1/4" hexagon drive

#### 810/1 Bitholding screwdriver with retaining ring



	EAN						
Code	4013288		mm	mm	mm		
05051005001	012258	1/4"	120	112	10,5	4 3/4"	2

### Kraftform Kompakt Vario with Ratchet Function

High quality bit holder. Includes a ratchet: fine-toothing with a small return angle, switchover (right, fixed, left), maximum torque of up to 50 Newton metres.

The Rapidaptor quick-release chuck enables rapid bit change without needing any special tools. The strong permanent magnet holds the bits absolutely securely. Kraftform Plus handle for pleasant, ergonomic working that makes blisters and calluses a thing of the past.

Hard gripping zones for high working speeds whereas soft zones ensure high torque transfer. Suitable for bits with 1/4" hexagon head drive as per DIN ISO 1173-C 6.3 and E 6.3 (ISO 1173).

- Ratcheting screwdriver with Rapidaptor technology for rapid bit change
- Ratchet with fine-pitched toothing for a low return angle
- Switchover (right, fixed, left)
- Maximum torque of up to 50 Newton metres
- Multi-component Kraftform handle for fast and ergonomic screwdriving

### 816 RA Ratchet screwdriver



	EAN							
Code	4013288		mm					
05051461001	156280	1/4"	142,0					1

<sup>1)</sup> Discontinued item. New version available from 1 June 2025.

### Kraftform Kompakt 60 RA



	EAN							
Code	4013288							
05051040001	155290							1

	<b>816 RA</b> 1x 1/4"x142,0	
	<b>851/4 Z PH</b> 1x PH 1x89; 1x PH 2x89; 1x PH 3x89 <sup>1)</sup>	
	<b>855/4 Z PZ</b> 1x PZ 1x89; 1x PZ 2x89; 1x PZ 3x89 <sup>1)</sup>	
	<b>867/4 Z TORX® B0</b> 1x TX 10x89; 1x TX 15x89; 1x TX 20x89; 1x TX 25x89; 1x TX 30x89	
	<b>800/4 Z</b> 1x 1,0x5,5x89	
	<b>840/4 Z Hex-Plus</b> 1x 3,0x89; 1x 4,0x89; 1x 5,0x89; 1x 6,0x89 <sup>1)</sup>	

<sup>1)</sup> Hexagonal blade

<sup>\*)</sup> Discontinued item. New version available from 1 June 2025.

### Kraftform Kompakt 60 RA, imperial



	EAN							
Code	4013288							
05051041001	155306							1
	<b>816 RA</b> 1x 1/4"x142,0							
	<b>851/4 Z PH</b> 1x PH 1x89; 1x PH 2x89; 1x PH 3x89 <sup>1)</sup>							
	<b>867/4 Z TORX® B0</b> 1x TX 10x89; 1x TX 15x89; 1x TX 20x89; 1x TX 25x89; 1x TX 30x89							
	<b>800/4 Z</b> 1x 1,0x5,5x89							
	<b>840/4 Z Hex-Plus</b> 1x 3/32"x89; 1x 1/8"x89; 1x 5/32"x89; 1x 3/16"x89							
	<b>868/4 Square-Plus</b> 1x # 1x89; 1x # 2x89; 1x # 3x89							

<sup>1)</sup> Hexagonal blade

<sup>\*)</sup> Discontinued item. New version available from 1 June 2025.

### 80 RA Vario ratchet screwdriver

Ratchet, fine-pitched toothing for a low return angle, switch-over ring (right, fixed, left), maximum torque of up to 50 Newton meters; 6 mm hexagon take-up.

Kraftform Plus handle for pleasant, ergonomic working that makes blisters and calluses a thing of the past. Hard gripping zones for high working speeds whereas soft zones ensure high torque transfer.

- Vario ratcheting screwdriver for Wera 6 mm Vario blades
- Ratchet with fine-pitched toothing for a low return angle
- Switchover ring (right, fixed, left)
- Maximum torque of up to 50 Newton metres
- Smooth hard zones for high speed turning, soft grip zones for high torque transfer

### 80 RA Vario ratchet screwdriver



	EAN							
Code	4013288	mm	mm					
05002901001	156242	6	115,0					1

<sup>\*)</sup> Discontinued item. New version available from 1 June 2025.

### Kraftform Kompakt Vario RA SB



Code	EAN		
05073665001	156266		1
		○ 80 RA 1x 6x115,0	
		⊕ 85 1x PH 1xPH 2x175	
		⊕ 86 1x PZ 1xPZ 2x175	
		⊕ 87 1x TX 10xTX 15x175; 1x TX 20xTX 25x175	
		⊕ 81 1x 0,6x4,0x1,0x6,0x175	
		○ 84 1x 4x5x175 <sup>1)</sup>	

<sup>1)</sup> without ball-end

<sup>2)</sup> Discontinued item. New version available from 1 June 2025.

### Kraftform Kompakt Pistol RA

Wera compact tool with multi-component Kraftform pistol handle for high working speeds and particularly ergonomic screwdriving.

Integrated bit magazine in the handle. Includes a ratchet: fine-toothing with a small return angle of only 8°, switchover (right, fixed, left), maximum torque of up to 50 Newton metres; hexagonal blade with 1/4" hexagon socket head take-up and Rapidaptor technology, magnetic. 6 bits PH, PZ and TORX® in a length of 25 mm that fit in holders as per DIN ISO 1173-D 6.3. Comes with a practical holster for belt attachment.

- Fine-toothing for a small return angle of only 8°
- Simple to use switchover ring
- Quick-release chuck with Rapidaptor technology
- Strong permanent magnet for secure fit of bits
- Multi-component Kraftform pistol handle for greater leverage effect

### Kraftform Kompakt Pistol RA



Code	EAN		
05051030001	180360		1
		814 RA 1x 1/4"	
		⊕ 851/1 Z PH 1x PH 1x25; 1x PH 2x25	
		⊕ 855/1 Z PZ 1x PZ 1x25; 1x PZ 2x25	
		⊕ 867/1 TORX® 1x TX 20x25; 1x TX 25x25	

<sup>2)</sup> Discontinued item. New version available from 1 June 2025.

### Kraftform Kompakt Pistol RA 4



Code	EAN		
05051031001	187406		1
		814 RA 1x 1/4"	
		⊕ 851/1 BTZ PH 1x PH 1x25; 1x PH 2x25	
		⊕ 855/1 BTZ PZ 1x PZ 1x25; 1x PZ 2x25	
		⊕ 867/1 TORX® BTZ 1x TX 20x25; 1x TX 25x25	
		⊕ 851/4 Z PH 1x PH 1x89; 1x PH 2x89	
		⊕ 855/4 Z PZ 1x PZ 1x89; 1x PZ 2x89	
		⊕ 867/4 Z TORX® 1x TX 20x89; 1x TX 25x89	

<sup>2)</sup> Discontinued item. New version available from 1 June 2025.

## Kraftform Kompakt 27 RA

Wera compact tool with multi-component Kraftform handle for high working speeds and particularly ergonomic screwdriving. Integrated bit magazine in the handle.

Includes ratchet: fine-pitched for small return angle, switchover ring (right, fixed, left), maximum torque of up to 50 Nm; hexagonal blade with 1/4" hexagon socket take-up, stainless sleeve, strong permanent magnet.

- Kraftform Kompakt with ratchet function for high working speeds
- Kraftform with anti-roll feature, multi-component, integrated magazine
- Fine-pitched teeth for small return angle; switchover ring (right, fixed, left)
- Maximum torque of up to 50 Newton metres
- Hexagon blade with 1/4" hex socket take-up, stainless sleeve, strong permanent magnet

### Kraftform Kompakt 27 RA 1 SB

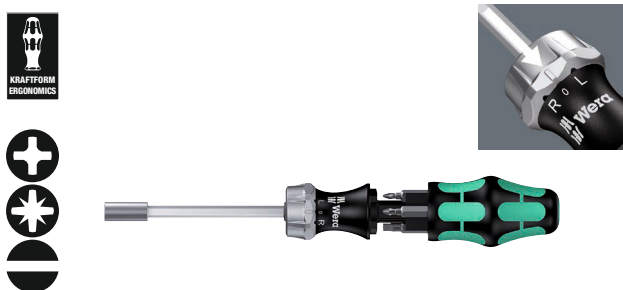

Code	EAN			
05073660001	156051			1
		+	851/1 Z PH 1x PH 1x25; 1x PH 2x25	
		+	855/1 Z PZ 1x PZ 1x25; 1x PZ 2x25	
		⊖	800/1 Z 1x 1,0x5,5x25; 1x 1,2x6,5x25	

<sup>1</sup> Discontinued item. New version available from 1 June 2025.

### Kraftform Kompakt 27 RA 2 SB



Code	EAN			
05073661002	156068			1
		+	851/1 Z PH 1x PH 1x25; 1x PH 2x25	
		⊖	800/1 Z 1x 1,0x5,5x25; 1x 1,2x6,5x25	
		□	868/1 Z 1x # 1x25; 1x # 2x25	

<sup>1</sup> Discontinued item. New version available from 1 June 2025.

## 88/1 Vario set

11-piece Vario set with handle and blades. In a practical belt pouch, enabling the tools to be safely and securely stored and to always be at hand. The Kraftform grip on the handle stands for pleasant, ergonomic working and makes blisters and calluses a thing of the past.

Hard gripping zones for high working speeds whereas soft zones ensure high torque transfer. The hexagonal non-roll feature prevents any annoying rolling away at the workplace. The integrated hex bolster allows higher torque to be applied with an open-end or ring spanner.

The double blades are out of high quality bit material and are therefore particularly durable. The Wera Black Point tip on the blade offers a perfect fit and optimised corrosion protection.

- Vario set with handle and 10 combination blades
- Smooth hard zones for high speed turning, soft grip zones for high torque transfer
- Chrome-plated hexagonal blade material, 6 mm
- Black Point tip offers a perfect fit with optimised corrosion protection
- In a robust belt pouch

### 88/1 Vario set



Code	EAN			
05002990001	000675			1
		●	80 1x 6x98	
		+	85 1x PH 1xPH 2x175	
		+	86 1x PZ 1xPZ 2x175	
		+	87 1x TX 10xTX 15x175; 1x TX 20xTX 25x175; 1x TX 30xTX 40x175	
		⊖	81 1x 0,6x4,0x1,0x6,0x175; 1x 0,8x5,0x1,2x7,0x175	
		○	84 1x 4x4x175; 1x 5x5x175; 1x 6x6x175	

## 80 Vario handle

- Kraftform handle with 10 mm hex bolster
- Suitable for insertion of 6 mm Vario blades or a Vario adaptor

### 80 Vario handle



	EAN						
<b>Code</b>	4013288	mm	mm	mm			
05002900001	000460	6	10	98			5

## 95 Vario T-handle hand holder for Vario blades

T-handle screwdriver: The ideal handle shape to allow high torque transmission in difficult tightening and loosening situations. The ergonomic shape of the handle fills the palm of the hand well, the fingers lie safely in the soft rounded handle recesses.

The whole hand makes contact with the handle and friction losses between the hand and the handle are avoided. Bit holder for bits with 1/4" external hexagon drive as per DIN ISO 1173-C 6.3 in magnetic design for easier placement of the screws.

- T-handle screwdriver for the transmission of particularly high tightening and loosening moments
- Ergonomic 2-component handle with finger handle recesses and pleasant surface feel for very high power transmission and fatigue-free working.
- Vario T-handle for 6 mm Vario blades and adaptor

### 95 Vario T-handle hand holder for Vario blades



	EAN						
<b>Code</b>	4013288	mm	mm	mm	mm		
05023400001	208446	6	60	44	100	2 23/64"	2

## 830 Vario bit holder adaptor

- Vario adaptor blade with quick-release chuck for Vario holder
- Suitable for take-up of bits with 1/4" hexagon head drive
- 1/4" quick-release chuck with strong permanent magnet

### 830 Vario bit holder adaptor



	EAN						
<b>Code</b>	4013288	mm	mm	mm			
05051835001	012425	1/4"	6	165	6 9/16"		2

## 91 Vario extension

- Vario extension for Vario blades and adaptor
- Chrome-plated hexagonal material, 6 mm

### 91 Vario extension



	EAN						
<b>Code</b>	4013288	mm	mm	mm			
05003210001	000804	6	6	175	7"		2

## 712 Vario socket adaptor

- For sockets

### 712 Vario socket adaptor



	EAN						
<b>Code</b>	4013288		mm	mm			
05040001001	006165	1/4"	6	175	7"		2

## Combination blades

Combination blade for Vario handles. The double-ended blades are made out of high quality bit material and are therefore particularly durable. The Wera Black Point tip offers a perfect fit and optimised corrosion protection.

### 81 Combination blade for slotted screws



	EAN								
<b>Code</b>	4013288	mm	mm	mm	mm	mm	mm	mm	
05002910001	000477	0,6	4,0	1,0	6,0	6	175	7"	5
05002913001	000484	0,8	5,0	1,2	7,0	6	175	7"	5

### 82 Combination blade for slotted/Phillips screws



	EAN								
<b>Code</b>	4013288			mm	mm	mm	mm		
05002920001	000491	PH 1		0,6	4,0	6	175	7"	5
05002923001	000507	PH 2		1,0	6,0	6	175	7"	5
05002926001	000514	PH 3		1,2	7,0	6	175	7"	5

### 83 Combination blade for Phillips/Pozidriv screws



	EAN						
<b>Code</b>	4013288			mm	mm		
05002930001	000521	PH 1	PZ 1	6	175	7"	5
05002933001	000538	PH 2	PZ 2	6	175	7"	5

### 84 Combination blade for hexagon socket screws



	EAN						
<b>Code</b>	4013288			mm	mm		
05002936001	000545	2,5	2,5	6	175	7"	5
05002938001	000552	3	3	6	175	7"	5
05002940001	000569	4	4	6	175	7"	5
05002943001	000576	5	5	6	175	7"	5
05002948001 <sup>1)</sup>	155436	4	5	6	175	7"	5
05002946001	000583	6	6	6	175	7"	5

<sup>1)</sup>without ball-end

### 85 Combination blade for Phillips screws



	EAN						
<b>Code</b>	4013288			mm	mm		
05002950001	000590	PH 1	PH 2	6	175	7"	5

### 86 Combination blade for Pozidriv screws



	EAN						
<b>Code</b>	4013288			mm	mm		
05002960001	000606	PZ 1	PZ 2	6	175	7"	5
05140310001	000613	PZ 2	PZ 3	6	175	7"	5

### 87 Combination blade for TORX® screws



	EAN						
<b>Code</b>	4013288			mm	mm		
05002966001	000620	TX 6	TX 8	6	175	7"	5
05002968001	000637	TX 7	TX 9	6	175	7"	5
05002970001	000644	TX 10	TX 15	6	175	7"	5
05002973001	000651	TX 20	TX 25	6	175	7"	5
05002976001	000668	TX 30	TX 40	6	175	7"	5

### 68 Combination blade for square socket head screws



	EAN						
<b>Code</b>	4013288			mm	mm		
05002980001	100061	#1	#2	6	175	7"	5





# Roller cabinet and foam inserts



## 9700 Tool Rebel Roller Cabinet 1

Exclusive roller cabinet in the Tool Rebel design. Five flat and two high drawers ensure efficient, mobile organization of tools and materials.

Extremely robust thanks to a double-walled design and the completely welded construction of the entire body. For daily hard work in the workshop.

Equipped with four Wera foam inserts: 9710 foam insert screwdriver set 1, 9720 foam insert 8000 A Zyklop ratchet set 1, 9731 foam insert 6003 Joker ring spanner set 1, 9740 foam insert L-key set 1.

- Exclusive roller cabinet in the Tool Rebel design
- Extremely robust design thanks to a double-walled design
- With 7 drawers (5 flat, 2 high) – of which 2 flat drawers are equipped with foam inserts and tools (e.g. with Zyklop Speed ratchet and accessories, Joker spanners, Kraftform screwdrivers, L-keys)
- Dimensions flat drawers (width x height x depth): 522 x 81 x 398 mm
- Dimensions high drawers (width x height x depth): 522 x 166 x 398 mm
- 100 % drawer pull-out with ball bearing telescopic slides, self-closing
- All drawers are elaborately and individually layered
- Minimum risk of tilting over thanks to the drawer stop – only one drawer can be opened, no simultaneous pull-out of multiple drawers
- Both sides with square head boring
- High-quality, durable foam inserts without chemical vapours
- Optimum fit for the best possible removal of the tools from the foam inserts

## 9700 Tool Rebel Roller Cabinet 1



Code	EAN		
	4013288		
05150130001	225085		1
<b>1x 9710</b>			
<b>Foam insert screwdriver set 1</b>			
		<b>932 A</b> 1x 1,0x5,5x100; 1x 1,2x7,0x125	
		<b>350</b> 1x PH 1x80; 1x PH 2x100; 1x PH 3x150	
		<b>350 PH Stubby/carburetor screwdriver</b> 1x PH 2x25	
		<b>355</b> 1x PZ 1x80; 1x PZ 2x100	
		<b>335</b> 1x 0,8x4,0x100; 1x 1,0x5,5x125	
		<b>334</b> 1x 1,2x6,5x150	
		<b>335 Stubby/carburetor screwdriver</b> 1x 1,0x5,5x24,5	
		<b>2050 Micro</b> 1x PH 0x40 <sup>1)</sup>	
		<b>2035 Micro</b> 1x 0,40x2,5x80	
		<b>160 i VDE</b> 1x 0,4x2,5x80 <sup>2)</sup> ; 1x 0,6x3,5x100 <sup>2)</sup>	
		<b>1441</b> 1x 4,5-6,0x41,0	
		<b>1442</b> 1x 6,0-8,5x41,0	
		<b>9810</b> 1x 344,0x30,0x392,0 <sup>3)</sup>	

<b>1x 9720</b> <b>Foam insert 8000 A Zyklop 1/4" ratchet set 1</b>	
○	<b>8000 A</b> 1x 1/4"x152,0
●○	<b>8794 LA</b> 1x 1/4"x150,0
●○	<b>8794 SA</b> 1x 1/4"x75,0
●○	<b>8795 A</b> 1x 1/4"x35,5
●○	<b>8794 A</b> 1x 1/4"x56,0
●	<b>8790 HMA</b> 1x 4,0x23,0; 1x 4,5x23,0; 1x 5,0x23,0; 1x 5,5x23,0; 1x 6,0x23,0; 1x 7,0x23,0; 1x 8,0x23,0; 1x 9,0x23,0; 1x 10,0x23,0; 1x 11,0x23,0; 1x 12,0x23,0; 1x 13,0x23,0; 1x 14,0x23,0; 1x 15,0x23,0
✳	<b>8767 A HF</b> 1x TX 8x28,0; 1x TX 9x28,0; 1x TX 10x28,0; 1x TX 15x28,0; 1x TX 20x28,0; 1x TX 25x28,0; 1x TX 27x28,0; 1x TX 30x28,0; 1x TX 40x28,0
○	<b>8740 A HF</b> 1x 3,0x28,0; 1x 4,0x28,0; 1x 4,0x100,0; 1x 5,0x28,0; 1x 5,0x100,0; 1x 6,0x28,0; 1x 6,0x100,0; 1x 8,0x28,0; 1x 8,0x100,0
	<b>9820</b> 1x 172,0x30,0x392,0 <sup>3)</sup>
<b>1x 9731</b> <b>Foam insert 6003 Joker set 1</b>	
	<b>6003 Joker</b> 1x 6x105; 1x 7x110; 1x 8x115; 1x 9x120; 1x 10x125; 1x 11x135; 1x 12x148; 1x 13x160; 1x 14x167; 1x 15x174; 1x 16x182; 1x 17x190; 1x 18x210; 1x 19x230; 1x 20x230; 1x 21x260; 1x 22x260; 1x 24x280
	<b>Bottle opener</b> 1x 145
	<b>9831</b> 1x 344,0x30,0x392,0 <sup>3)</sup>
<b>1x 9740</b> <b>Foam insert L-key set 1</b>	
<b>1x 950/9 Hex-Plus Multicolour 1</b>	
○	<b>950 SPKL Multicolour</b> 1x 1,5x90; 1x 2,0x101; 1x 2,5x112; 1x 3,0x123; 1x 4,0x137; 1x 5,0x154; 1x 6,0x172; 1x 8,0x195; 1x 10,0x224
<b>1x 967/9 TX XL Multicolour 1</b>	
✳	<b>967 SXL TORX® Multicolour</b> 1x TX 8x90; 1x TX 9x101; 1x TX 10x112
✳	<b>967 SPKXL TORX® Multicolour</b> 1x TX 15x123; 1x TX 20x137; 1x TX 25x154; 1x TX 27x172; 1x TX 30x195; 1x TX 40x224
	<b>1x 9500 Magnetiser SB</b> 1x 64,6
	<b>1x STABILA® BM 100 Pocket tape, metric scale, 3 m, item 19570</b>
	<b>1x 9840</b> 1x 172,0x30,0x392,0 <sup>3)</sup>

<sup>1)</sup> Size 0 modified according to JCIS 0 (Japanese Camera Industrial Standard)

<sup>2)</sup> without Lasertip

<sup>3)</sup> Attention: The foam insert does not fit in the previous model 05501051001 of the roller cabinet.

## 9710 Foam insert screwdriver set 1

Durable foam insert; two-coloured for quick identification of missing parts; suitable for the Tool Rebel roller cabinet, equipped with 16 Wera Kraftform screwdrivers (workshop, VDE, chiseldriver, Micro) as well as 2 screw grippers.

- Durable foam insert, each tool has its own place; two-coloured, missing tools will quickly be noticed
- High-quality, durable foam insert without chemical vapours
- Optimum fit for the best possible removal of the tools from the foam insert
- Water- and oil-repellent, low maintenance and easy to clean
- Protection of the tool from dirt and impact
- 8 Kraftform Plus screwdrivers with hard zones for high working speeds and soft handle zones for a high torque transfer
- 2 Kraftform Plus VDE screwdrivers with insulated blades for safe working up to 1,000 volt
- 2 Kraftform Micro screwdrivers with a rotating cap for fast turning
- 2 Stubby screwdrivers with short blade for hard-to-reach areas
- Two screw grippers (attachment tools with gripping function for screws)
- Width x height x depth: without tools 344 x 30 x 392 mm, with tools 344 x 47 x 392 mm

## 9710 Foam insert screwdriver set 1

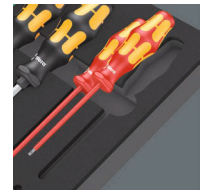

Code	EAN		
05150101001	4013288 225122		1
		● <b>932 A</b> 1x 1,0x5,5x100; 1x 1,2x7,0x125	
		● <b>350</b> 1x PH 1x80; 1x PH 2x100; 1x PH 3x150	
		● <b>350 PH Stubby/carburetor screwdriver</b> 1x PH 2x25	
		● <b>355</b> 1x PZ 1x80; 1x PZ 2x100	
		● <b>335</b> 1x 0,8x4,0x100; 1x 1,0x5,5x125	
		● <b>334</b> 1x 1,2x6,5x150	
		● <b>335 Stubby/carburetor screwdriver</b> 1x 1,0x5,5x24,5	
		● <b>2050 Micro</b> 1x PH 0x40 <sup>1)</sup>	
		● <b>2035 Micro</b> 1x 0,40x2,5x80	
		● <b>160 i VDE</b> 1x 0,4x2,5x80 <sup>2)</sup> ; 1x 0,6x3,5x100 <sup>2)</sup>	
		<b>1441</b> 1x 4,5-6,0x41,0	
		<b>1442</b> 1x 6,0-8,5x41,0	
		<b>9810</b> 1x 344,0x30,0x392,0 <sup>3)</sup>	

<sup>1)</sup> Size 0 modified according to JCIS 0 (Japanese Camera Industrial Standard)

<sup>2)</sup> without Lasertip

<sup>3)</sup> Attention: The foam insert does not fit in the previous model 05501051001 of the roller cabinet.

### 9711 Foam insert VDE screwdriver set 1

- Screwdriver with insulated blades for safe working up to 1,000 volt, five of which with reduced blade diameter for lower-lying screws
- Two screw grippers (attachment tools with gripping function for screws)
- Width x height x depth: without tools 344 x 30 x 392 mm, with tools 344 x 46 x 392 mm

#### 9711 Foam insert VDE screwdriver set 1

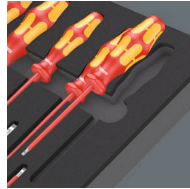

Code	EAN		
05150102001	4013288 225320		1
		<b>162 iS PH VDE</b> 1x PH 1x80; 1x PH 2x100	
		<b>165 iS PZ VDE</b> 1x PZ 1x80; 1x PZ 2x100	
		<b>165 i PZ/S VDE</b> 1x # 2x100	
		<b>160 i VDE</b> 1x 0,4x2,5x80 <sup>1)</sup> ; 1x 0,8x4,0x100; 1x 1,0x5,5x125	
		<b>160 iS VDE</b> 1x 0,6x3,5x100	
		<b>167 i TORX® VDE</b> 1x TX 10x80; 1x TX 15x80; 1x TX 20x80; 1x TX 25x100; 1x TX 30x100	
		<b>1440</b> 1x 4,5-6,0x41,0	
		<b>1442</b> 1x 6,0-8,5x41,0	
		<b>9811</b> 1x 344,0x30,0x392,0 <sup>2)</sup>	

<sup>1)</sup> without Lasertip

<sup>2)</sup> Attention: The foam insert does not fit in the previous model 05501051001 of the roller cabinet.

### 9712 Foam insert TORX® HF screwdriver set 1

- 6 Kraftform Plus screwdrivers with hard zones for high working speeds and soft handle zones for a high torque transfer
- 4 Kraftform Micro screwdrivers with a rotating cap for fast turning
- 4 T-handle screwdrivers for the transmission of particularly high tightening and loosening moments
- Width x height x depth: without tools 344 x 30 x 392 mm, with tools 344 x 45 x 392 mm

#### 9712 Foam insert TORX® HF screwdriver set 1

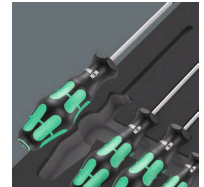
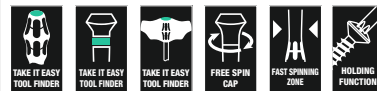

Code	EAN		
05150103001	4013288 225283		1
		<b>367 TORX® HF</b> 1x TX 8x60; 1x TX 9x60; 1x TX 10x80; 1x TX 15x80; 1x TX 20x100; 1x TX 25x100	
		<b>2067 TORX® HF Micro</b> 1x TX 4x40; 1x TX 5x40; 1x TX 6x40; 1x TX 7x60	
		<b>467 TORX® HF</b> 1x TX 20x100; 1x TX 25x100; 1x TX 30x200; 1x TX 40x200	
		<b>9812</b> 1x 344,0x30,0x392,0 <sup>1)</sup>	

<sup>1)</sup> Attention: The foam insert does not fit in the previous model 05501051001 of the roller cabinet.

### 9713 Foam insert Hex screwdriver set 1

- 4 Kraftform Plus screwdrivers with hard zones for high working speeds and soft handle zones for a high torque transfer, two of which with hollow shaft for protruding thread rods
- 3 Kraftform Micro screwdrivers with a rotating cap for fast turning
- 5 T-handle screwdrivers for the transmission of particularly high tightening and loosening moments, with holding function for hexagonal socket screws
- With Hex-Plus profile (prevents hexagonal socket screws from cylindrical turning)
- Width x height x depth: without tools 344 x 30 x 392 mm, with tools 344 x 45 x 392 mm

### 9713 Foam insert Hex screwdriver set 1

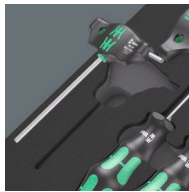
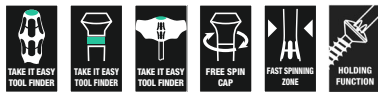

Code	EAN		
05150104001	225290		1
		○ 354 1x 3,0x75; 1x 4,0x75	
		○ 2054 Micro 1x 1,5x60; 1x 2x60; 1x 2,5x60	
		○ 454 HF 1x 4x100; 1x 5x100; 1x 6x150; 1x 8x200; 1x 10x200	
		● 395 HO 1x 10,0x90; 1x 13,0x90	
		9813 1x 344,0x30,0x392,0 <sup>1)</sup>	

<sup>1)</sup> Attention: The foam insert does not fit in the previous model 05501051001 of the roller cabinet.

### 9714 Foam insert The Chiseldriver screwdriver set 1

- 13 chiseldrivers for screwdriving, chiseling, mortising
- Hexagonal blade extending through the handle
- Impact cap and bolster for the transfer of higher torque
- Width x height x depth: without tools 344 x 30 x 392 mm, with tools 344 x 46 x 392 mm

### 9714 Foam insert The Chiseldriver screwdriver set 1

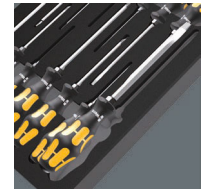

Code	EAN		
05150105001	232540		1
		⊕ 917 SPH 1x PH 1x80; 1x PH 2x100; 1x PH 3x150	
		⊕ 918 SPZ 1x PZ 1x80; 1x PZ 2x100; 1x PZ 3x150	
		● 932 A 1x 0,6x3,5x80 <sup>1)</sup> ; 1x 0,8x4,5x90; 1x 1,0x5,5x100; 1x 1,2x7,0x125; 1x 1,6x9,0x150	
		⊕ 977 TORX® 1x TX 20x90; 1x TX 25x100	
		9814 1x 344,0x30,0x392,0	

<sup>1)</sup> No throughout blade, no impact cap and no hexagon bolster

<sup>2)</sup> Attention: The foam insert does not fit in the previous model 05501051001 of the roller cabinet.



### 9715 Foam insert Krafftform Micro screwdriver set 1

- Krafftform Micro screwdriver
- Multi-component Krafftform Micro handle for fast and ergonomic screwdriving
- Anti-roll feature and swivel cap for rapid twisting
- The Wera Black Point tip offers an exact fit and optimum corrosion protection
- "Take it easy" tool finder: colour coding according to profile and size
- Width x height x depth: without tools 344 x 30 x 392 mm, with tools 344 x 38 x 392 mm

### 9715 Foam insert Krafftform Micro screwdriver set 1

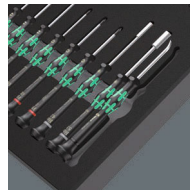

Code	EAN		
05150106001	4013288 232557		1
		<b>2050 Micro</b> 1x PH 000x40 <sup>1)</sup> 2); 1x PH 00x40 <sup>1)</sup> 2); 1x PH 0x40 <sup>3)</sup>	
		<b>2067 TORX® HF</b> 1x TX 5x40; 1x TX 6x40; 1x TX 7x60; 1x TX 8x60; 1x TX 10x60	
		<b>2067 TORX PLUS® IPR Micro</b> 1x 1 IPRx40 <sup>4)</sup>	
		<b>2072 Micro</b> 1x mx40	
		<b>2054 Micro</b> 1x 0,7x40; 1x 0,9x40; 1x 1,3x40; 1x 1,5x60; 1x 2x60	
		<b>2035 Micro</b> 1x 0,23x1,5x40; 1x 0,30x1,8x60; 1x 0,35x2,5x40; 1x 0,40x2,0x60; 1x 0,40x2,5x80; 1x 0,50x3,0x80	
		<b>2069 Micro</b> 1x 4,0x60; 1x 5,5x60	
		<b>1429</b> 1x 1,0x3,5x50	
		<b>9815</b> 1x 344,0x30,0x392,0	

<sup>1)</sup> Optimised for Asian PH screws

<sup>2)</sup> On the output side, the blade is turned to a nominal length of 10 mm

<sup>3)</sup> Size 0 modified according to JCIS 0 (Japanese Camera Industrial Standard)

<sup>4)</sup> Without bore hole

<sup>7)</sup> Attention: The foam insert does not fit in the previous model 05501051001 of the roller cabinet.

### 9720 Foam insert 8000 A Zyklop 1/4" ratchet set 1

- The Zyklop Speed ratchet combines five ratchet types in one
- With flywheel design and slip-proof fast-rotating sleeve for extremely high working speed
- Freely pivoting ratchet head, push button release and left/right switchover
- Fine-tooth design allows a small return angle of 5°
- Can also be used as a screwdriver
- Set including sockets, bit sockets, extensions and universal joint
- 14 sockets, 9 bit sockets with holding function for TORX® screws, 9 bit sockets with holding function for hexagonal socket screws
- Width x height x depth: without tools 172 x 30 x 392 mm, with tools 172 x 40 x 392 mm

### 9720 Foam insert 8000 A Zyklop 1/4" ratchet set 1



Code	EAN		
05150110001	4013288 225139		1
		<b>8000 A</b> 1x 1/4"x152,0	
		<b>8794 LA</b> 1x 1/4"x150,0	
		<b>8794 SA</b> 1x 1/4"x75,0	
		<b>8795 A</b> 1x 1/4"x35,5	
		<b>8794 A</b> 1x 1/4"x56,0	
		<b>8790 HMA</b> 1x 4,0x23,0; 1x 4,5x23,0; 1x 5,0x23,0; 1x 5,5x23,0; 1x 6,0x23,0; 1x 7,0x23,0; 1x 8,0x23,0; 1x 9,0x23,0; 1x 10,0x23,0; 1x 11,0x23,0; 1x 12,0x23,0; 1x 13,0x23,0; 1x 14,0x23,0; 1x 15,0x23,0	
		<b>8767 A HF</b> 1x TX 8x28,0; 1x TX 9x28,0; 1x TX 10x28,0; 1x TX 15x28,0; 1x TX 20x28,0; 1x TX 25x28,0; 1x TX 27x28,0; 1x TX 30x28,0; 1x TX 40x28,0	
		<b>8740 A HF</b> 1x 3,0x28,0; 1x 4,0x28,0; 1x 4,0x100,0; 1x 5,0x28,0; 1x 5,0x100,0; 1x 6,0x28,0; 1x 6,0x100,0; 1x 8,0x28,0; 1x 8,0x100,0	
		<b>9820</b> 1x 172,0x30,0x392,0 <sup>1)</sup>	

<sup>1)</sup> Attention: The foam insert does not fit in the previous model 05501051001 of the roller cabinet.

### 9721 Foam insert 8000 B Zyklop 3/8" ratchet set 1

- The Zyklop Speed ratchet combines five ratchet types in one
- With flywheel design and slip-proof fast-rotating sleeve for extremely high working speed
- Freely pivoting ratchet head, push button release and left/right switchover
- Fine-tooth design allows a small return angle of 5°
- Can also be used as a screwdriver
- Set including sockets, extensions and universal joint
- Width x height x depth: without tools 172 x 30 x 392 mm, with tools 172 x 45 x 392 mm

### 9721 Foam insert 8000 B Zyklop 3/8" ratchet set 1



Code	EAN		
	4013288		
05150111001	225306		1
		<b>8000 B</b> 1x 3/8"x199,0	
		<b>8794 SB</b> 1x 3/8"x125,0	
		<b>8794 LB</b> 1x 3/8"x200,0	
		<b>8795 B</b> 1x 3/8"x50,0	
		<b>8794 B</b> 1x 3/8"x76,0	
		<b>8790 HMB</b> 1x 6,0x29,0; 1x 7,0x29,0; 1x 8,0x29,0; 1x 9,0x29,0; 1x 10,0x29,0; 1x 11,0x29,0; 1x 12,0x29,0; 1x 13,0x29,0; 1x 14,0x29,0; 1x 15,0x29,0; 1x 16,0x30,0; 1x 17,0x30,0; 1x 18,0x30,0; 1x 19,0x30,0; 1x 20,0x30,0; 1x 21,0x30,0; 1x 22,0x30,0; 1x 24,0x32,0	
		<b>9821</b> 1x 172,0x30,0x392,0 <sup>1)</sup>	

<sup>1)</sup> Attention: The foam insert does not fit in the previous model 05501051001 of the roller cabinet.

### 9722 Foam insert 8000 C Zyklop 1/2" ratchet set 1

- The Zyklop Speed ratchet combines five ratchet types in one
- Freely pivoting ratchet head, push button release and left/right switchover
- Fine-tooth design allows a small return angle of 5°
- Set including sockets, extensions and universal joint
- 17 sockets, 9 bit sockets with holding function for hexagonal socket screws
- Width x height x depth: without tools 344 x 30 x 392 mm, with tools 344 x 51 x 392 mm

### 9722 Foam insert 8000 C Zyklop 1/2" ratchet set 1

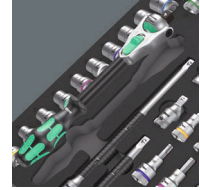

Code	EAN		
	4013288		
05150112001	225207		1
		<b>8000 C</b> 1x 1/2"x277,0	
		<b>8794 LC</b> 1x 1/2"x250,0	
		<b>8794 SC</b> 1x 1/2"x125,0	
		<b>8795 C</b> 1x 1/2"x69,0	
		<b>8794 C</b> 1x 1/2"x52,0	
		<b>8790 HMC</b> 1x 10,0x37,0; 1x 11,0x37,0; 1x 12,0x37,0; 1x 13,0x37,0; 1x 14,0x37,0; 1x 15,0x37,0; 1x 16,0x37,0; 1x 17,0x37,0; 1x 18,0x37,0; 1x 19,0x37,0; 1x 20,0x37,0; 1x 21,0x37,0; 1x 22,0x37,0; 1x 24,0x37,0; 1x 27,0x40,0; 1x 30,0x42,0; 1x 32,0x42,0	
		<b>8740 C HF</b> 1x 4,0x60,0; 1x 4,0x140,0; 1x 5,0x60,0; 1x 5,0x140,0; 1x 6,0x60,0; 1x 6,0x140,0; 1x 7,0x60,0; 1x 8,0x60,0; 1x 10,0x60,0	
		<b>9822</b> 1x 344,0x30,0x392,0 <sup>1)</sup>	

<sup>1)</sup> Attention: The foam insert does not fit in the previous model 05501051001 of the roller cabinet.



### 9723 Foam insert Zyklop B 3/8" bit socket set 1

- Bit socket (non-impact) for manual or power tool operations
- 10 bit sockets with holding function for TORX® screws, 11 bit sockets with holding function for hexagonal socket screws, one Zyklop connector with quick-release chuck for 1/4" bits
- With Take it easy tool finder: colour coding by size
- Knurling on lower end for more grip when used manually
- Chrome-vanadium makes for hardness and strength
- Width x height x depth: without tools 172 x 30 x 392 mm, with tools 172 x 39 x 392 mm

### 9723 Foam insert Zyklop B 3/8" bit socket set 1



Code	EAN		
05150113001	4013288 225313		1
		<b>8784 B1</b> 1x 1/4"x3/8"x44,0	
		<b>8767 B HF</b> 1x TX 15x35,0; 1x TX 20x35,0; 1x TX 25x35,0; 1x TX 25x107,0; 1x TX 27x35,0; 1x TX 27x107,0; 1x TX 30x35,0; 1x TX 30x107,0; 1x TX 40x35,0; 1x TX 40x107,0	
		<b>8740 B HF</b> 1x 4,0x35,0; 1x 4,0x107,0; 1x 5,0x35,0; 1x 5,0x107,0; 1x 6,0x35,0; 1x 6,0x107,0; 1x 7,0x38,5; 1x 8,0x38,5; 1x 8,0x100,0; 1x 10,0x38,5; 1x 10,0x100,0	
		<b>9823</b> 1x 172,0x30,0x392,0 <sup>1)</sup>	

<sup>1)</sup> Attention: The foam insert does not fit in the previous model 05501051001 of the roller cabinet.

### 9724 Foam insert 8010 B Zyklop Comfort ratchet set 1, 3/8"

- One Zyklop Comfort ratchet, 14x 8790 B Impaktor sockets, one 8798 B Zyklop extension; 3/8"
- Zyklop Comfort ratchet with pleasant feel thanks to the plastic sleeve
- Plastic coating protects surfaces from damage
- Fine toothing with 80 teeth for a short return angle of only 4.5°
- Extremely slim design with a soft, ergonomic grip zone for easy work even in very confined spaces
- Safe socket lock via push button, convenient direction change thanks to the reversing lever
- 8790 B Impaktor sockets also for use with electric or pneumatic wrenches, 3/8"
- Sockets with Impaktor technology for higher-than-average service life
- Sockets with "Take it easy" tool finder: Colour coding by size
- Width x height x depth: without tools 172 x 30 x 392 mm, with tools 172 x 48 x 392 mm

### 9724 Foam insert 8010 B Zyklop Comfort ratchet set 1, 3/8"

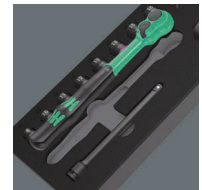

Code	EAN		
05150114001	4013288 232564		1
		<b>8010 B</b> 1x 3/8"x230,0	
		<b>8790 B Impaktor</b> 1x 8,0x30,0; 1x 10,0x30,0; 1x 11,0x30,0; 1x 12,0x30,0; 1x 13,0x30,0; 1x 14,0x30,0; 1x 15,0x30,0; 1x 16,0x30,0; 1x 17,0x30,0; 1x 18,0x30,0; 1x 19,0x30,0; 1x 21,0x32,0; 1x 22,0x32,0; 1x 24,0x32,0	
		<b>8798 B</b> 1x 3/8"x152,4	
		<b>9824</b> 1x 172,0x30,0x392,0	

<sup>1)</sup> Attention: The foam insert does not fit in the previous model 05501051001 of the roller cabinet.



## 9725 Foam insert Zyklop C, 1/2", Impaktor Deep socket set 1

- Robust Impaktor socket wrench inserts for extremely high stress; for use with electric or pneumatic wrenches with 12.5 mm = 1/2" drive
- Long socket wrenches for low-lying couplings, also suitable for fitting, protruding thread rods in confined spaces
- Hexagon profile for precise and profile-friendly screwdriving at a high power transmission
- With cross-bore and ring socket for securing locking pin and locking ring of machine-operated tools
- Width x height x depth: without tools 172 x 30 x 392 mm, with tools 172 x 48 x 392 mm

### 9725 Foam insert Zyklop C, 1/2", Impaktor Deep socket set 1



Code	EAN		
05150115001	4013288 232571		1
		<b>8790 C Impaktor Deep</b> 1x 13,0x83,0; 1x 14,0x83,0; 1x 15,0x83,0; 1x 16,0x83,0; 1x 17,0x83,0; 1x 18,0x83,0; 1x 19,0x83,0; 1x 21,0x83,0; 1x 22,0x83,0; 1x 24,0x83,0; 1x 27,0x83,0	
		<b>9825</b> 1x 172,0x30,0x392,0	
*) Attention: The foam insert does not fit in the previous model 05501051001 of the roller cabinet.			

## 9726 Foam insert 8007 B VDE Zyklop VDE ratchet set 1, 3/8"

- Insulated and 100% individually tested Zyklop 8007 B ratchet for safe working up to 1,000 volt
- Fine-toothed ratchet with 80 teeth for a return angle of only 4.5°
- Extremely slim design with a soft, ergonomic grip zone for easy work even in very confined spaces
- Plastic coating protects surfaces from damage
- Sockets, bit sockets and extensions with increased safety thanks to a 2-component insulation with yellow insulation core under red outer insulation layer
- 8767 B VDE HF bit sockets with holding function for TORX® screws as per the specification Acument Intellectual Properties
- 8740 B VDE HF bit sockets with holding function for hexagonal socket screws
- Width x height x depth: without tools 344 x 30 x 392 mm, with tools 344 x 45 x 392 mm

### 9726 Foam insert 8007 B VDE Zyklop VDE ratchet set 1, 3/8"

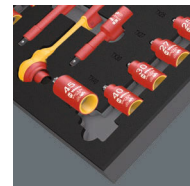

Code	EAN		
05150116001	4013288 232519		1
		<input type="checkbox"/> <b>8007 B VDE</b> 1x 3/8"x222,0	
		<input type="checkbox"/> <b>410 i VDE B</b> 1x 3/8"x130	
		<input checked="" type="checkbox"/> <b>8790 B VDE</b> 1x 6,0x46,0; 1x 7,0x46,0; 1x 8,0x46,0; 1x 9,0x46,0; 1x 10,0x46,0; 1x 11,0x46,0; 1x 12,0x46,0; 1x 13,0x46,0; 1x 14,0x46,0; 1x 15,0x46,0; 1x 16,0x46,0; 1x 17,0x46,0; 1x 18,0x46,0; 1x 19,0x46,0	
		<input checked="" type="checkbox"/> <b>8767 B VDE HF</b> 1x TX 20x55,0; 1x TX 25x55,0; 1x TX 27x55,0; 1x TX 30x55,0; 1x TX 40x55,0; 1x TX 45x59,0	
		<input checked="" type="checkbox"/> <b>8740 B VDE HF</b> 1x 4,0x55,0; 1x 5,0x55,0; 1x 6,0x55,0; 1x 8,0x59,0	
		<input checked="" type="checkbox"/> <b>8794 SB VDE</b> 1x 3/8"x91,0	
		<input checked="" type="checkbox"/> <b>8794 LB VDE</b> 1x 3/8"x166,0	
		<b>9826</b> 1x 344,0x30,0x392,0	

\*) Attention: The foam insert does not fit in the previous model 05501051001 of the roller cabinet.

### 9730 Foam insert 6000 Joker set 1

- Ring ratchet spanner with useful holding function by a metal plate in the mouth
- No slipping down thanks to the end stop
- Double hexagon geometry reduces the risk of slipping to the side
- Return angle of only 30°
- With Take it easy tool finder: colour coding by size
- Width x height x depth: without tools 172 x 30 x 392 mm, with tools 172 x 47 x 392 mm

### 9730 Foam insert 6000 Joker set 1



Code	EAN		
05150120001	4013288 225214		1
		<b>6000 Joker</b> 1x 8x144; 1x 10x159; 1x 11x165; 1x 12x170,7; 1x 13x177; 1x 14x188; 1x 15x200; 1x 16x212; 1x 17x224; 1x 18x235; 1x 19x246	
		<b>9830</b> 1x 172,0x30,0x392,0 <sup>1)</sup>	
<sup>1)</sup> Attention: The foam insert does not fit in the previous model 05501051001 of the roller cabinet.			

### 9731 Foam insert 6003 Joker set 1

- Ring spanner, perfect for small spaces
- The special mouth geometry expands the placement possibilities of the tool
- The low return angle in the mouth "takes" the screw every 15°
- Slim ring side with 15° crank
- With Take it easy tool finder: colour coding by size
- Iconic bottle opener with original Kraftform Plus handle
- Width x height x depth: without tools 344 x 30 x 392 mm, with tools 344 x 58 x 392 mm

### 9731 Foam insert 6003 Joker set 1



Code	EAN		
05150121001	4013288 225115		1
		<b>6003 Joker</b> 1x 6x105; 1x 7x110; 1x 8x115; 1x 9x120; 1x 10x125; 1x 11x135; 1x 12x148; 1x 13x160; 1x 14x167; 1x 15x174; 1x 16x182; 1x 17x190; 1x 18x210; 1x 19x230; 1x 20x230; 1x 21x260; 1x 22x260; 1x 24x280	
		<b>Bottle opener</b> 1x 145	
		<b>9831</b> 1x 344,0x30,0x392,0 <sup>1)</sup>	
<sup>1)</sup> Attention: The foam insert does not fit in the previous model 05501051001 of the roller cabinet.			

### 9732 Foam insert 6004 Joker set 1

- The adjustable Joker 6004 covers all metric and imperial dimensions in the respective field of application
- Automatic and continuous gripping of the hexagon screw or bolt
- Lever mechanism when gripping avoids slippage and damage
- Fast and consistent screwdriving without removing the wrench thanks to mechanical ratchet function
- Return angle of only 30° through placement in the corner-width rectangular prisms in the mouth
- Width x height x depth: without tools 172 x 30 x 392 mm, with tools 172 x 35 x 392 mm

### 9732 Foam insert 6004 Joker set 1



Code	EAN		
05150122001	4013288 225337		1
		<b>6004 Joker XS</b> 1x 7-10 ( $1/4''-3/8''$ )x117	
		<b>6004 Joker S</b> 1x 10-13 ( $7/16''-1/2''$ )x154	
		<b>6004 Joker M</b> 1x 13-16 ( $1/2''-5/8''$ )x188	
		<b>6004 Joker L</b> 1x 16-19 ( $5/8''-3/4''$ )x224	
		<b>6004 Joker XL</b> 1x 19-24 ( $3/4''-15/16''$ )x256	
		<b>9832</b> 1x 172,0x30,0x392,0 <sup>1)</sup>	

<sup>1)</sup> Attention: The foam insert does not fit in the previous model 05501051001 of the roller cabinet.

### 9733 Foam insert 6001 Joker Switch set 1

- Reversible 6001 Joker Switch ratcheting combination wrench
- Ratchet end tilted by 15°
- Practical holding function thanks to the metal plate in the jaw
- Limit stop prevents any slipping
- Very fine toothing and robust locking element
- With Take it easy tool finder: colour coding by size
- Width x height x depth: without tools 172 x 30 x 392 mm, with tools 172 x 48 x 392 mm

### 9733 Foam insert 6001 Joker Switch set 1

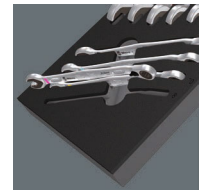

Code	EAN		
05150123001	4013288 232496		1
		<b>6001 Joker Switch</b> 1x 8x144; 1x 10x159; 1x 11x165; 1x 12x171; 1x 13x179; 1x 14x187; 1x 15x199; 1x 16x213; 1x 17x225; 1x 18x234; 1x 19x246	
		<b>9833</b> 1x 172,0x30,0x392,0	

<sup>1)</sup> Attention: The foam insert does not fit in the previous model 05501051001 of the roller cabinet.



### 9734 Foam insert 6004 Joker VDE set 1

- 6004 Joker VDE XS for wrench size 7-10 (metric) or 1/4"-3/8" (imperial); 6004 Joker VDE S for wrench size 10-13 (metric) or 7/16"-1/2" (imperial); 6004 Joker VDE M for wrench size 13-16 (metric) or 1/2"-5/8" (imperial); 6004 Joker VDE L for wrench size 16-19 (metric) or 5/8"-3/4" (imperial)
- Individually tested tools with insulated handles for safe working up to 1,000 volt, with anti-slip protection and sliding function for contactless and safe opening of the non-insulated jaws
- Automatic and continuous grip of hexagon screws and bolts
- Lever mechanism when gripping avoids slippage and damage
- Fast and consistent screwdriving without removing the wrench thanks to mechanical ratchet functionality
- Return angle of only 30° through placement in the corner-width rectangular prisms in the open end
- Width x height x depth: without tools 172 x 30 x 392 mm, with tools 172 x 40 x 392 mm

### 9734 Foam insert 6004 Joker VDE set 1

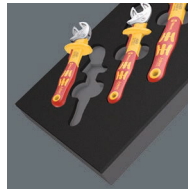

Code	EAN		
05150124001	232502		1
		<b>6004 Joker VDE XS</b> 1x 7-10 (1/4"-3/8")x119	
		<b>6004 Joker VDE S</b> 1x 10-13 (7/16"-1/2")x155	
		<b>6004 Joker VDE M</b> 1x 13-16 (1/2"-5/8")x190	
		<b>6004 Joker VDE L</b> 1x 16-19 (5/8"-3/4")x226	
		<b>9834</b> 1x 172,0x30,0x392,0	

<sup>1)</sup> Attention: The foam insert does not fit in the previous model 05501051001 of the roller cabinet.

### 9740 Foam insert L-key set 1

- Thanks to their Hex-Plus profile, the 950 L-keys let hexagonal socket screws live longer
- All L-keys with Take it easy tool finder: Colour coding by size
- All L-keys have a colour-coded, easy-grip hose sleeve for ergonomic and comfortable operation even at low temperatures
- Magnetiser 9500 for magnetising and demagnetising tool tips so that screws can be held on the tool by magnetic force
- Width x height x depth: without tools 172 x 30 x 392 mm, with tools 172 x 44 x 392 mm

### 9740 Foam insert L-key set 1



Code	EAN		
05150140001	225108		1
		<b>1x 950/9 Hex-Plus Multicolour 1</b>	
		<b>950 SPKL Multicolour</b> 1x 1.5x90; 1x 2.0x101; 1x 2.5x112; 1x 3.0x123; 1x 4.0x137; 1x 5.0x154; 1x 6.0x172; 1x 8.0x195; 1x 10.0x224	
		<b>1x 967/9 TX XL Multicolour 1</b>	
		<b>967 SXL TORX® Multicolour</b> 1x TX 8x90; 1x TX 9x101; 1x TX 10x112	
		<b>967 SPKXL TORX® Multicolour</b> 1x TX 15x123; 1x TX 20x137; 1x TX 25x154; 1x TX 27x172; 1x TX 30x195; 1x TX 40x224	
		<b>1x 9500</b>	
		1x 48.0	
		<b>1x STABILA®</b>	
		1x STABILA® BM 100 Pocket tape, metric scale, 3 m, item 19570	
		<b>1x 9840</b>	
		1x 172,0x30,0x392,0 <sup>1)</sup>	

<sup>1)</sup> Attention: The foam insert does not fit in the previous model 05501051001 of the roller cabinet.

## 9750 Foam insert Kraftform Kompakt and Tool-Check PLUS set 1

- Kraftform Kompakt 60: Folding pouch with 89 mm long bits and 816 R bitholding screwdriver with Rapidaptor quick-release chuck and multi-component Kraftform handle for fatigue-free working
- Tool-Check PLUS: 39-piece tool combination of ratchet, sockets and one bitholding screwdriver
- Bitholding screwdriver extra slim with flexible shaft and very slim design for working in confined spaces
- Width x height x depth: without tools 172 x 30 x 392 mm, with tools 172 x 59 x 392 mm

## 9750 Foam insert Kraftform Kompakt and Tool-Check PLUS set 1

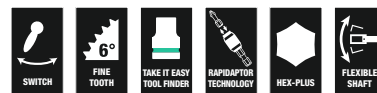

Code	EAN		
05150150001	4013288 225344		1
<b>1x Tool-Check PLUS</b>			
	⊖	<b>8001 A</b> 1x 1/4"x87.0	
	●	<b>813</b> 1x 1/4"x78	
	⊙	<b>889/4/1 K</b> 1x 1/4"x50	
	⊖	<b>870/1</b> 1x 1/4"x25 <sup>1)</sup>	
	●	<b>8790 HMA</b> 1x 5.5x23.0; 1x 6.0x23.0; 1x 7.0x23.0; 1x 8.0x23.0; 1x 10.0x23.0; 1x 12.0x23.0; 1x 13.0x23.0	
	+	<b>851/1 TZ</b> 2x PH 1x25; 3x PH 2x25; 1x PH 3x25	
	+	<b>855/1 TH</b> 1x PZ 1x25; 3x PZ 2x25; 1x PZ 3x25	
	⊕	<b>867/1 TZ TORX®</b> 1x TX 10x25; 1x TX 15x25; 1x TX 20x25; 1x TX 25x25; 1x TX 30x25; 1x TX 40x25	
	⊕	<b>867/1 Z TORX® BO</b> 1x TX 10x25; 1x TX 15x25; 1x TX 20x25; 1x TX 25x25; 1x TX 30x25	
	○	<b>840/1 Z</b> 1x 3.0x25; 1x 4.0x25; 1x 5.0x25; 1x 6.0x25; 1x 8.0x25	
	⊖	<b>800/1 TZ</b> 1x 1.0x5.5x25	
<b>1x Kraftform Kompakt 60</b>			
	●	<b>816 R</b> 1x 1/4"x119	
	+	<b>851/4 Z</b> 1x PH 1x89; 1x PH 2x89; 1x PH 3x89 <sup>2)</sup>	
	+	<b>855/4 Z</b> 1x PZ 1x89; 1x PZ 2x89; 1x PZ 3x89 <sup>2)</sup>	
	⊕	<b>867/4 Z TORX® BO</b> 1x TX 10x89; 1x TX 15x89; 1x TX 20x89; 1x TX 25x89; 1x TX 30x89	
	⊖	<b>800/4 Z</b> 1x 1.0x5.5x89	
	○	<b>840/4 Z</b> 1x 3.0x89; 1x 4.0x89; 1x 5.0x89; 1x 6.0x89 <sup>2)</sup>	
		<b>Hook and Loop Fastener Strip 70</b> 1x 50.0x70.0	
<b>1x 393 S Bitholding screwdriver extra slim with flexible shaft</b>			
	●	1x 1/4"x173,5	
<b>1x 9850</b>			
		1x 172,0x30,0x392,0 <sup>3)</sup>	

<sup>1)</sup> With friction ball; for manual nut spinner sockets

<sup>2)</sup> Hexagonal blade

<sup>3)</sup> Attention: The foam insert does not fit in the previous model 05501051001 of the roller cabinet.



### 9751 Foam insert Kraftform Kompakt VDE set 1

- 837 i RA VDE handle with ratchet functionality; for Kraftform Kompakt
- 817 VDE handle for Kraftform Kompakt interchangeable blades
- VDE blades (157 mm length) with practical spinning function, anti-roll protection and "Take it easy" Tool finder: Colour coding by profile and laser-engraved size indication
- 14 interchangeable blades with reduced blade diameter and integrated protective insulation (iS)
- interchangeable blades with "Take it easy" Tool finder: Colour coding by profile and laser-engraved size indication
- Width x height x depth: without tools 344 x 30 x 392 mm, with tools 344 x 46 x 392 mm

### 9751 Foam insert Kraftform Kompakt VDE set 1

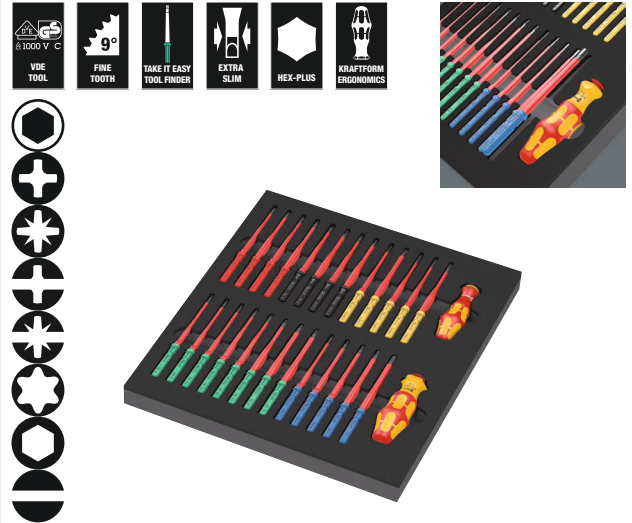

Code	EAN		
	4013288		
05150151001	232526		1
		<b>837 i RA</b> 1x 9x115	
		<b>817 VDE</b> 1x 9x98	
		<b>Kraftform Kompakt VDE 62 iS Take it easy</b> 1x PH 1x157; 1x PH 2x157	
		<b>Kraftform Kompakt VDE 65 iS Take it easy</b> 1x PZ 1x157; 1x PZ 2x157	
		<b>Kraftform Kompakt VDE 62 iS PH/S Take it easy</b> 1x # 1x157; 1x # 2x157	
		<b>Kraftform Kompakt VDE 65 iS PZ/S Take it easy</b> 1x # 1x157; 1x # 2x157	
		<b>Kraftform Kompakt VDE 67 i Take it easy</b> 1x TX 8x157; 1x TX 9x157; 1x TX 10x157; 1x TX 27x157; 1x TX 30x157	
		<b>Kraftform Kompakt VDE 67 iS Take it easy</b> 1x TX 15x157; 1x TX 20x157; 1x TX 25x157	
		<b>Kraftform Kompakt VDE 64 i Take it easy</b> 1x 2,5x157; 1x 3,0x157; 1x 4,0x157; 1x 5,0x157; 1x 6,0x157	
		<b>Kraftform Kompakt VDE 60 iS Take it easy</b> 1x 0,6x3,5x157; 1x 0,8x4,0x157; 1x 1,0x5,5x157	
		<b>Kraftform Kompakt VDE 60 i Take it easy</b> 1x 0,4x2,5x157; 1x 1,2x6,5x157	
		<b>9851</b> 1x 344,0x30,0x392,0	

<sup>\*)</sup> Attention: The foam insert does not fit in the previous model 05501051001 of the roller cabinet.

## 9752 Foam insert Kraftform Kompakt with ratchet functionality set 1

- 838 RA-R M bitholding screwdriver with integrated ratchet functionality (fine toothing, 36 teeth, return angle 10°) for 1/4" bits
- 416 RA T-handle bitholding screwdriver with integrated ratchet (fine toothing, 80 teeth, return angle 4,5°) for 1/4" bits
- Ergonomic 2-component T-handle
- 816 R bitholding screwdriver with ergonomic Kraftform handle and Rapidaptor quick-release chuck for 1/4" bits
- Rapidaptor quick-release chuck for lightning-fast bit changes; with strong permanent magnet
- Zyklop 8001 A Mini bit ratchet (60 teeth, return angle 6°), drop-forged solid steel design; for 1/4" bits and with adapter for 1/4" sockets
- 870/1 connection part for manually operated sockets; adapts from 1/4" external hexagon to 1/4" external square head
- Magnetiser 9500 for magnetising and demagnetising tool tips
- Tough bits for universal use
- Width x height x depth: without tools 172 x 30 x 392 mm, with tools 172 x 42 x 392 mm

## 9752 Foam insert Kraftform Kompakt with ratchet functionality set 1

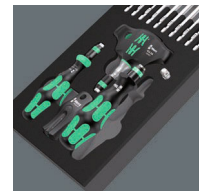

Code	EAN		
	4013288		
05150152001	232533		1
		<b>838 RA-R M</b> 1x 1/4"x123,5	
		<b>416 RA</b> 1x 1/4"x45	
		<b>816 R</b> 1x 1/4"x119	
		<b>8001 A</b> 1x 1/4"x87,0	
		<b>851/4 Z</b> 1x PH 1x89; 1x PH 2x89; 1x PH 3x89 <sup>1)</sup>	
		<b>855/4 Z</b> 1x PZ 1x89; 1x PZ 2x89; 1x PZ 3x89 <sup>1)</sup>	
		<b>867/4 Z TORX®</b> 1x TX 10x89; 1x TX 15x89; 1x TX 20x89; 1x TX 25x89; 1x TX 27x89; 1x TX 30x89; 1x TX 40x89	
		<b>840/4 Z</b> 1x 3,0x89; 1x 4,0x89; 1x 5,0x89; 1x 6,0x89 <sup>1)</sup>	
		<b>800/4 Z</b> 1x 1,0x5,5x89	
		<b>870/1</b> 1x 1/4"x25 <sup>2)</sup>	
		<b>9500</b> 1x 64,6	
		<b>9852</b> 1x 172,0x30,0x392,0	

<sup>1)</sup> Hexagonal blade

<sup>2)</sup> With friction ball; for manual nut spinner sockets

<sup>3)</sup> Attention: The foam insert does not fit in the previous model 05501051001 of the roller cabinet.



### 9780 Foam insert KNIPEX pliers set 1

- Width x height x depth: without tools 172 x 30 x 392 mm, with tools 172 x 38 x 392 mm

#### 9780 Foam insert KNIPEX pliers set 1



Code	EAN		
05150180001	4013288 225153		1
		<b>KNIPEX Combination Pliers 03 05 180</b> 1x 180	
		<b>KNIPEX Cobra® High-Tech Water Pump Pliers 87 05 250</b> 1x 250	
		<b>KNIPEX High Leverage Diagonal Cutter 74 05 160</b> 1x 160	
		<b>9880</b> 1x 172,0x30,0x392,0 <sup>1)</sup>	

<sup>1)</sup> Attention: The foam insert does not fit in the previous model 05501051001 of the roller cabinet.

### 9781 Foam insert KNIPEX pliers set 2

- Width x height x depth: without tools 172 x 30 x 392 mm, with tools 172 x 38 x 392 mm

#### 9781 Foam insert KNIPEX pliers set 2



Code	EAN		
05150181001	4013288 225177		1
		<b>KNIPEX Snipe Nose Cutting Pliers (Stork Beak Pliers) 26 15 200</b> 1x 200	
		<b>KNIPEX Mechanics' Pliers 38 25 200</b> 1x 200	
		<b>KNIPEX Electricians' Shears 95 05 155</b> 1x 155	
		<b>9881</b> 1x 172,0x30,0x392,0 <sup>1)</sup>	



<sup>1)</sup> Attention: The foam insert does not fit in the previous model 05501051001 of the roller cabinet.

### 9782 Foam insert hammer set 1

- Width x height x depth: without tools 172 x 30 x 392 mm, with tools 172 x 35 x 392 mm

#### 9782 Foam insert hammer set 1



Code	EAN		
05150182001	4013288 225191		1
		<b>PICARD® riveting hammer 500 g, 0000101-500</b> 1x 500,0	
		 <b>RENNSTEIG Parallel pin punches Exclusive</b> 1x 452 003 6 RC, 3,0x150; 1x 452 004 6 RC, 4,0x150; 1x 452 006 6 RC, 6,0x150; 1x 452 008 6 RC, 8,0x150	
		 <b>RENNSTEIG Flat cold chisel 310 250 1</b> 1x 25,0x13,0x23,0	
		<b>9882</b> 1x 172,0x30,0x392,0 <sup>1)</sup>	

<sup>1)</sup> Attention: The foam insert does not fit in the previous model 05501051001 of the roller cabinet.



### 9783 Foam insert PFERD file set 1

- Width x height x depth: without tools 344 x 30 x 392 mm, with tools 344 x 42 x 392 mm

### 9783 Foam insert PFERD file set 1

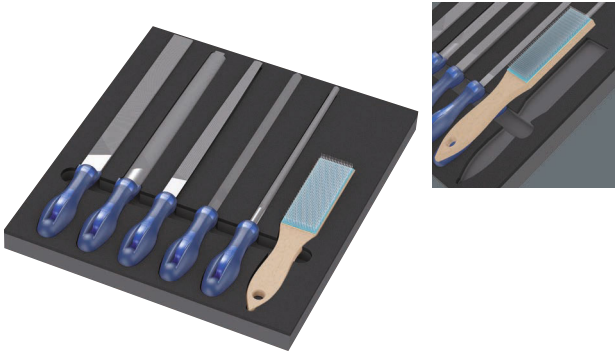

Code	EAN		
05150183001	4013288 225368		1
		PFERD machinist's file square PF1142 250 H2 1x 250	
		PFERD machinist's file half-round pointed 1152SP 250 H2 1x 250	
		PFERD machinist's file round 1162 250 H2 1x 250	
		PFERD machinist's file hand 1112 250 H2 1x 250	
		PFERD machinist's file three square 1132 250 H2 1x 250	
		PFERD scratch brush HBF steel wire Ø 0.15 1x 232	
		<b>9883</b> 1x 344,0x30,0x392,0 <sup>1)</sup>	

<sup>1)</sup> Attention: The foam insert does not fit in the previous model 05501051001 of the roller cabinet.

### 9784 Foam insert KNIPEX pliers set VDE 1

- Width x height x depth: without tools 172 x 30 x 392 mm, with tools 172 x 38 x 392 mm

### 9784 Foam insert KNIPEX pliers set VDE 1



Code	EAN		
05150184001	4013288 232489		1
		KNIPEX Diagonal stripper 70 06 160	
		KNIPEX Snipe nose pliers with blade (stork beak pliers) 26 16 200	
		KNIPEX Needle-nose combination pliers 08 26 185	
		<b>9884</b> 1x 172,0x30,0x392,0	

<sup>1)</sup> Attention: The foam insert does not fit in the previous model 05501051001 of the roller cabinet.





# Wera 2go



## Wera 2go 1 Tool Carrier

The Wera 2go 1 is the super lightweight and mobile tool carrier for all Wera pouches and textile boxes equipped with hook and loop zone on their reverse sides.

The pouches and boxes are easily and securely attached individually to the tool carrier. The hands remain free during transport thanks to the shoulder strap that is included.

- Wera 2go Tool Carrier with hook and loop fastener system
- For the docking of the Wera textile boxes and pouches with hook and loop fastener zones
- Individually configurable for greater mobility
- Hands remain free during Transport
- Includes an adjustable, detachable Shoulder Strap with a wide padded section

## Wera 2go 1 Tool Carrier



Code	EAN		
05004350001	187352		1
		Wera 2go 5 1x 135,0x300,0x270,0	
		Wera 2go 6 1x 38,0x1470,0	

## Wera 2go 2 Tool Container

The Wera 2go tool container is the ideal solution for individual and convenient tool transport thanks to its hook and loop fastener system and its compactness. The inner and outer hook and loop fastener zones ensure a maximum in terms of space utilisation. This means that an incredible number of tools can fit in and on the container.

Wera 2go 2 ensures a low weight since only the tools really needed for the job are taken along. The robust and dimensionally stable material protects the tools carried against damage and moisture and enhances the service life of the tool container.

The padded and width-adjustable shoulder strap and the snug fit of the container on the body mean that the container is easy and convenient to carry.

The hands remain free during transport. It comes with a quiver with an individually adjustable hook and loop fastener partition for screwdrivers and other tools.

- Wera 2go tool container with inner and outer hook and loop fastener zones
- Individually configurable for greater mobility
- Ideal also for the docking of Wera textile boxes and pouches equipped with hook and loop fastener zones

## Wera 2go 2 Tool Container



Code	EAN		
05004351001	187840		1
		Wera 2go Container 1x 355,0x330,0x115,0	
		Wera 2go 6 1x 38,0x1470,0	
		Wera 2go 4 1x 165,0x165,0x105,0	

## Wera 2go 2 XL Tool Container

The Wera 2go 2 XL Tool Container with extra low-profile compartments, with its hook and loop fastener system and its compactness, is the ideal solution for individual and convenient tool transport. The inner and outer hook and loop fastener zones provide extremely high flexibility and space utilization.

This fits an incredible amount of tools in and on the container. Wera 2go 2 makes for light luggage, because only the essential tools are taken.

The robust and sturdy material protects the enclosed tools from damage and moisture, and increases the service life of the tool container.

The padded and adjustable wide belt and the close-fitting position of the container provide a comfortable fit.

The hands remain free during transport. Including one Wera 2go 4 holder with individually adjustable hook and loop fastener divider for screwdrivers and other tools. Four of these holders can be stowed effortlessly.

- Wera 2go 2 XL Tool Container with extra low-profile compartments for e.g. the Wera 2go 4 Tool Quivers

### Wera 2go 2 XL Tool Container



Code	EAN							
05004357001	211491							1
		Wera 2go XL Container 1x 455,0x330,0x170,0						
		Wera 2go 6 1x 38,0x1470,0						
		Wera 2go 4 1x 165,0x165,0x105,0						

### Wera 2go 3 Tool Box

- Suitable for docking with the Wera 2go system
- Permanently dimensionally stable thanks to the fabric-lined plastic panels
- High resistance against cuts and stabs
- High protection for transported tools against damage and moisture
- Can be individually equipped

### Wera 2go 3 Tool Box



Code	EAN	mm	mm	mm				
05004352001	187369	130,0	325,0	80,0				1

### Wera 2go 4 Tool Quiver

- Suitable for docking with the Wera 2go system
- Dimensionally stable Wera 2go tool quiver
- High resistance against cuts and stabs
- Variable hook and loop fastener partition for a division into as many as 5 inner sections
- Large set-down area; handle for carrying and hanging up

### Wera 2go 4 Tool Quiver



Code	EAN	mm	mm	mm				
05004353001	187857	165,0	165,0	105,0				1

### Wera 2go 5 Tool Carrier

The Wera 2go 5 is the super lightweight and mobile tool carrier for all Wera pouches and textile boxes equipped with Velcro on their reverse sides. The pouches and boxes are easily and securely attached individually to the Wera 2go 5 article.

### Wera 2go 5 Tool Carrier



Code	EAN	mm	mm	mm				
05004354001	187383	135,0	300,0	270,0				1

## Wera 2go 6 Shoulder Strap

Shoulder strap for the Wera 2go tool transport system. It comes with extra wide, comfortable padding sections and adjustable strap length and is suitable for use with the Wera 2go 1 and 5 articles.

### Wera 2go 6 Shoulder Strap



	EAN								
Code	4013288	mm	mm						
05004355001	187390	38,0	1470,0						1

## Wera 2go 7 High Tool Box

- Transport box even for long tools such as spirit levels

### Wera 2go 7 High Tool Box



	EAN								
Code	4013288	mm	mm	mm					
05004356001	204370	295,0	100,0	100,0					1

## Wera 2go H 1 tool set for wood applications

Compact tool set with the 134 most important tools for woodwork with products by Wera, BESSEY®, "KIRSCHEN"®, KNIPEX, Lyra®, PICARD® and Stabila®.

Mobility is made considerably easy thanks to the compact tool container from the Wera 2go system.

- Extensive 134-piece tool set in compact Wera 2go tool container for carpenters on the go
- Premium brand tools by Wera, BESSEY®, "KIRSCHEN"®, KNIPEX, Lyra®, PICARD® and Stabila®
- Wera Kraftform Kompakt H 1 Wood (41-piece set) and Wera Bit-Safe 61 Wood 1 (61-piece set)
- 393 S extra slim bit hand holder with flexible shaft for applications in hard-to-reach work spaces
- Wera L-key with holding function: 967/9 TX XL Multicolour HF 1 (9-piece set) and 950/9 Hex-Plus Multicolour HF 1 (9-piece set)

## Wera 2go H 1 tool set for wood applications



Code	EAN		
	4013288		
05134011001	217677		1
		1x Wera 2go 2 Tool Container	
		1x Bit-Safe 61 Wood 1	
		1x Kraftform Kompakt H 1 Woodcraft	
		1x 967/9 TX XL Multicolour HF 1 L-key set with holding function, long	
		1x 950/9 Hex-Plus Multicolour HF 1 L-key set, metric, BlackLaser, with holding function	
		1x 393 S bits hand holder extra slim with flexible shaft	
		1x KNIPEX multigrip pliers COBRA® 250 mm 87 11 250	
		1x KNIPEX combination pliers 160 mm 03 01 160	
		1x KNIPEX carpenters' pincers 210 mm 50 00 210	
		1x Stabila® spirit level type 81 25 cm 02500 Torpedo	
		1x Carpenters' mallet 105 mm 52-1 P	
		1x "KIRSCHEN"® bevelled-edge chisel 10 mm 1001010	
		1x "KIRSCHEN"® bevelled-edge chisel 16 mm 1001016	
		1x "KIRSCHEN"® bevelled-edge chisel 20 mm 1001020	
		1x "KIRSCHEN"® bevelled-edge chisel 26 mm 1001026	
		1x BESSEY® Folding utility knife DBKPH-EU	
		1x Lyra® deep hole marker 4494202	

Product not available in the USA and Canada.

## Wera 2go E 1 Tool set for electricians

Compact tool set with the 73 most important tools for electricians with products by Wera, Jung, KNIPEX, Lyra®, PICARD®, PUK® and Stabila®.

Mobility is made considerably easier thanks to the compact tool container from the Wera 2go system.

- Extensive 73-piece tool set in the compact Wera 2go 2 tool container for electricians in mobile operations
- Premium brand tools by Wera, Jung, KNIPEX, Lyra®, PICARD®, PUK® and Stabila®
- Wera Kraftform Kompakt Turbo i 1 Tool Finder (16-piece handle/ interchangeable blades VDE set) for four times the screwdriving speed and Wera 8100 SA 6 Zyklop Speed ratchet set (1/4", 28-piece set)
- Joker 6004 S self-setting spanner for bolts and screws of 10-13mm (metric) and 7/16"-1/2" (imperial)
- With chiseldriver for screwdriving, chiselling, mortising as well as 4 VDE screwdrivers - 2 of which with stainless steel blade to prevent extraneous rust

## Wera 2go E 1 Tool set for electricians



Code	EAN		
	4013288		
05134025001	221278	1 x Wera 2go 2 Tool Container	1
		1 x 8100 SA 6 Zyklop Speed Ratchet Set, 1/4" drive, metric	
		1 x 950/9 Hex-Plus Multicolour HF 1 L-key set, metric, BlackLaser, with holding function	
		1 x Kraftform Kompakt Turbo i 1 Tool Finder	
		1x 932 A Screwdriver for slotted screws 1.2x7.0x125	
		1x 3162 i PH VDE Insulated screwdriver for Phillips screws, stainless PH 2x100	
		1x 3165 i PZ VDE Insulated screwdriver for Pozidriv screws, stainless PZ 2x100	
		1x 160 i VDE Insulated screwdriver for slotted screws 1.2x6.5x150	
		1x 160 iS VDE Insulated screwdriver with reduced blade diameter for slotted screws 0.6x3.5x100	
		1x 6004 Joker S self-setting spanner 10-13x7/16"-1/2"x154	
		1 x KNIPEX Combination pliers 160mm 01 06 160	
		1 x KNIPEX Diagonal insulation stripper 14 26 160	
		1 x KNIPEX Snipe nose pliers with blade (stork beak pliers) 26 16 200	
		1 x KNIPEX Cobra® VDE Hightech water pump pliers, insulated, 87 26 250	
		1 x KNIPEX Cable knife 98 52	
		1 x KNIPEX ErgoStrip® Universal dismantling tool 16 95 01	
		1 x PUK® 2200 Hand saw frame	
		1 x Lyra® Construction marker DRY PROFI 4494202	
		1 x STABILA® Spirit level Pocket Electric 17775	
		1 x STABILA® Spirit level type 70, 30 cm, 02281	
		1 x STABILA® Wooden folding rule type 607, 2 m, yellow, 01104	
		1 x PICARD® Fitter's hammer 400 g, German shape, 000101-0400	
		1 x Jung Plastering cup 127mm, 946 127 00	
		1 x Jung Scraping knife with natural wood handle, 922 050 00	



## Wera 2go SHK 1 Tool set for plumbing, heating and air conditioning

Compact tool set with the most important tools for HVAC services with products by Wera, BESSEY®, KNIPEX, Lyra®, PICARD®, PUK® and Stabila®. Mobility is made considerably easier thanks to the compact tool container from the Wera 2go system.

- Extensive 30-piece tool set in the compact Wera 2go 2 tool container for mobile HVAC applications
- Premium brand tools by Wera, BESSEY®, KNIPEX, Lyra®, PICARD®, PUK® and Stabila®
- Joker 6002 double spanner with practical holding function by a metal plate in the open end
- With chiseldriver for screwdriving, chiselling, mortising as well as 4 VDE screwdrivers - 2 of which with stainless steel blade to prevent extraneous rust
- 1/2" Zyklop Metal 8004 C ratchet (72 teeth, 5° low return angle) with reversing lever; slim design for very narrow spaces
- L-key set for hexagonal socket screws; the Hex-Plus profile reduces the cylindrical turning of hexagonal socket screws

## Wera 2go SHK 1 Tool set for plumbing, heating and air conditioning



Code	EAN	
05136071001	4013288 230300	1
		1x Wera 2go Container
		1x Wera 2go 6 Shoulder Strap
		1x Wera 2go 4 Tool Quiver
		1x 932 A Screwdriver for slotted screws 1.2x7.0x125
		1x 395 HO Nutdriver 10.0x90
		1x 395 HO Nutdriver 13.0x90
		1x 1060 i VDE-insulated Kraftform slotted screwdriver 0.6x3.5x100
		1x 1060 i VDE-insulated Kraftform slotted screwdriver 1.0x5.5x125
		1x 1062 i PH VDE-insulated Kraftform Phillips-head screwdriver PH 1x80
		1x 1062 i PH VDE-insulated Kraftform Phillips-head screwdriver PH 2x100
		1x 8004 C Zyklop Metal Ratchet with switch lever and 1/2" drive 1/2"x281
		1x 8790 HMC Zyklop socket with 1/2" drive 10.0x37.0
		1x 8790 HMC Zyklop socket with 1/2" drive 13.0x37.0
		1x 8790 HMC Zyklop socket with 1/2" drive 17.0x37.0
		1x 8790 HMC Zyklop socket with 1/2" drive 19.0x37.0
		1x Belt C (textile belt), 6 location, unloaded 45.0x275.0
		1x 6002 Joker Double open-ended wrenches 10x13x167
		1x 6002 Joker Double open-ended wrenches 17x19x235
		1x 6002 Joker Double open-ended wrenches 24x27x280
		1x 6002 Joker Double open-ended wrenches 30x32x305
		1x 950/9 Hex-Plus 2
		1x 9529 C SB 1/2" Step wrench 10.0x88.0
		1x KNIPEX Water pump pliers COBRA® 250mm 87 11 250
		1x KNIPEX Combination pliers 160mm 03 01 160
		1x KNIPEX Diagonal insulation stripper 14 26 160
		1x KNIPEX 001104 Pro wrench for standard shut-off systems
		1x STABILA® Spirit level type 70, 30 cm, 02281
		1x STABILA® Wooden folding rule type 607, 2 m, yellow, 01104
		1x PICARD® Fitter's hammer 400 g, German shape, 000101-0400
		1x PUK® 2200 Hand saw frame
		1x BESSEY® blades DBKPH-EU flick knife
		1x Lyra® Construction marker DRY PROFIL 4494202



### Hook and Loop Fastener Strip 1



Code	EAN		
05670446001	189448		1
		Hook and Loop Fastener Strip 70 1x 50,0x70,0	

### Hook and Loop Fastener Strip 2



Code	EAN		
05670447001	189455		1
		Hook and Loop Fastener Strip 120 1x 50,0x120,0	

### Hook and Loop Fastener Strip 3



Code	EAN		
05670448001	189462		1
		Hook and Loop Fastener Strip 240 1x 50,0x240,0	





# Bits



## Impaktor system - For an above-average service life

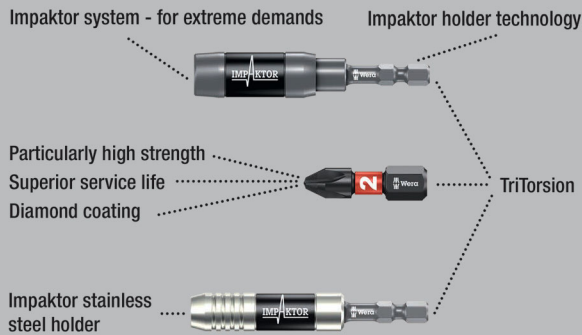

The Impaktor technology offers an above-average service life even under extreme circumstances.

Enhanced friction resistance, thanks to the rough diamond-particle coating on the bit tip, prevents any slipping out of the screw head.

Particularly suitable for use with customary impact drivers. 1/4" hexagon, suitable for holders as per DIN ISO 1173-D 6.3.

### 851/1 IMP DC PH DIY Impaktor PH bits



Code	EAN			
	4013288			
05057615001	178695	+	851/1 IMP DC 10x PH 1x25	1
05057616001	157638	+	851/1 IMP DC 10x PH 2x25	1
05057617001	157645	+	851/1 IMP DC 10x PH 3x25	1

### 851/1 IMP DC SB Impaktor bits



Code	EAN			
	4013288			
05073916001	158369	+	851/1 IMP DC 1x PH 2x25	5
05073917001	158376	+	851/1 IMP DC 1x PH 3x25	5

## Bit-Box 15 Impaktor PH



Code	EAN			
	4013288			
05057752001	187918	+	851/1 IMP DC 15x PH 2x25	10

## Kraftform Stainless - stainless steel to prevent rust

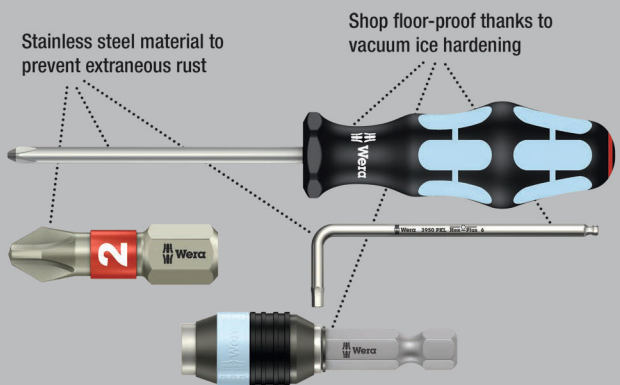

High quality bits out of stainless steel for cross-recess screws. Wera stainless are made out of stainless steel which prevents the formation of unsightly extraneous rust. Come with Torsion zone: Torsion bits take-up torque peaks and absorb them in the Torsion zone. This prevents premature wear and extends the service life of the bit. 1/4" hexagon, suitable for holders as per DIN ISO 1173-D 6.3.

### 3851/1 TS bits, stainless

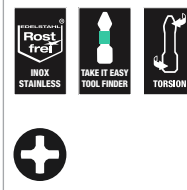

Code	EAN	+	mm	mm			
	4013288						
05071010001	110985	+	PH 1	25	1"		10
05071011001	110992	+	PH 2	25	1"		10
05071012001	111005	+	PH 3	25	1"		10

### 3851/1 TS SB bits, stainless



Code	EAN			
	4013288			
05073610001	112132	+	3851/1 TS PH 1x PH 1x25	5
05073611001	112149	+	3851/1 TS PH 1x PH 2x25	5

### BiTorsion system - for longer service life

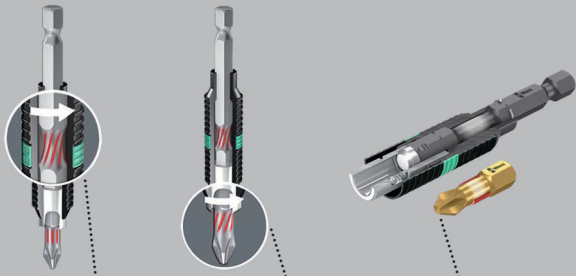

Smaller impacts are absorbed by the holder

Higher impacts are cushioned in the torsion zone of the bit

No premature wear caused by impacts

### 851/1 BDC bits

Bits with tiny diamond particles on the bit tip. This ensures a secure fit of the bit in the screw, reduces the contact pressure required and lowers the risk of slipping.

Comes with Torsion zone where kinetic energy is diverted from peak loads. This greatly extends the product service life; 1/4" hexagon, suitable for holders as per DIN ISO 1173-D 6.3.

### 851/1 BDC bits



Code	EAN	+	1"	1"					
	4013288		mm						
05056400001	033970	PH 1	25	1"					10
05056402001	033987	PH 2	25	1"					10
05056404001	033994	PH 3	25	1"					10

### 851/1 BDC SB bits



Code	EAN	+							
	4013288								
05073332001	029324	+	851/1 BDC PH 1x PH 1x25						5
05073333001	029331	+	851/1 BDC PH 1x PH 2x25						5
05073334001	029348	+	851/1 BDC PH 1x PH 3x25						5
05073335001	029355	+	851/1 BDC PH 2x PH 2x25						5

### 851/1 BTH bits

Bits with Torsion zone – where kinetic energy is diverted from peak loads – and BiTorsion zone to prevent the bit tip from twisting under peak loads.

This greatly extends the product service life. Extra-hard design, 1/4" hexagon, suitable for holders as per DIN ISO 1173-D 6.3.

### 851/1 BTH bits



Code	EAN	+	1"	1"					
	4013288		mm						
05056410001	034243	PH 1	25	1"					10
05056412001	034250	PH 2	25	1"					10
05056414001	034267	PH 3	25	1"					10



## 851/1 BTZ bits

Bits with Torsion zone – where kinetic energy is diverted from peak loads – and BiTorsion zone to prevent the bit tip from twisting under peak loads.

This greatly extends the product service life. Tough viscous, 1/4" hexagon, suitable for holders as per DIN ISO 1173-D 6.3.

### 851/1 BTZ bits



	EAN	+	□	□				
Code	4013288		mm					
05056420001	034458	PH 1	25	1"				10
05056422001	034465	PH 2	25	1"				10
05056424001	034472	PH 3	25	1"				10

### Bit-Box 20 BTZ PH



Code	EAN	+						
05057751001	187956	+	851/1 BTZ PH	20x PH 2x25				10

## Diamond-coated bits

Minute diamond particles on the tip of the tool literally bite into the screw

Bits fit securely into the head of the screw

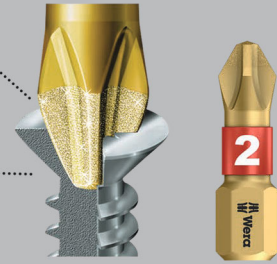

The diamond coating of the bits ensures a secure fit in the screw, reduces the contact pressure required and lowers the risk of slipping.

Profiled version with especially sharp edges which break away the paint when e.g. screw profiles are covered in it and this ensures a dependable transfer of power between the bit and screw.

1/4" hexagon, suitable for holders as per DIN ISO 1173-D 6.3.

## 851/1 A bits

Extra-hard design. Profiled version. 1/4" hexagon, suitable for holders as per DIN ISO 1173-D 6.3.

### 851/1 A bits



	EAN	+	□	□	∅			
Code	4013288		mm		mm			
05134919001	099976	PH 1	25	1"	4,5			10
05134920001	099983	PH 2	25	1"	6,0			10
05134921001	099990	PH 3	25	1"	-			10

## 851/1 RDC bits

High quality bits for drywall screws. Reduced shaft diameter for low-lying screw connections. Countersinking of screws without any surface damage.

Especially for drywall construction. The diamond coating of the bits ensures a secure fit in the screw, reduces the contact pressure required and lowers the risk of slipping. 1/4" hexagon, suitable for holders as per DIN ISO 1173-D 6.3.

### 851/1 RDC bits



	EAN	+	□	□	∅			
Code	4013288		mm		mm			
05135008001	032904	PH 2	25	1"	4,2			10

### 851/1 RH bits

Bits with reduced shaft diameter for low-lying screw connections. Countersinking of screws without any surface damage. Tough viscous for universal use. 1/4" hexagon, suitable for holders as per DIN ISO 1173-D 6.3.

#### 851/1 RH bits



	EAN	+	↓	↓	∅			
Code	4013288		mm		mm			
05346281001	107176	PH 2	25	1"	4,2			10

### 851/1 RZ bits

Bits for drywall screws. Reduced shaft diameter for low-lying screw connections. Tough viscous for universal use. 1/4" hexagon, suitable for holders as per DIN ISO 1173-D 6.3.

#### 851/1 RZ bits



	EAN	+	↓	↓	∅			
Code	4013288		mm		mm			
05135009001	032799	PH 2	25	1"	4,2			10

#### 851/1 RZ SB bits



Code	EAN	+						
05135005001	038456							
			851/1 RZ PH					
			2x PH 2x25					5

### 851/1 TH bits

The Torsion design means that torque peaks can be absorbed. This prevents premature wear and enhances the service life. Extra-hard; 1/4" hexagon, suitable for holders as per DIN ISO 1173-D 6.3.

#### 851/1 TH bits



	EAN	+	↓	↓				
Code	4013288		mm					
05056605001	013545	PH 1	25	1"				10
05056610001	013552	PH 2	25	1"				10
05056625001	013569	PH 3	25	1"				10

### 851/1 TiN bits

Extra-hard titanium nitride (TiN) coating for withstanding permanent loads such as e.g. in industrial applications. 1/4" hexagon, suitable for holders as per DIN ISO 1173-D 6.3.

#### 851/1 TiN bits



	EAN	+	↓	↓				
Code	4013288		mm					
05480172001	040992	PH 2	25	1"				10



### 851/1 TZ bits

- Ductile and tough for hard materials
- Torsion design against premature wear

#### 851/1 TZ bits



	EAN	+	⌀	ℓ				
Code	4013288		mm					
05056505001	013606	PH 1	25	1"				10
05056510001	013613	PH 2	25	1"				10
05056525001	013620	PH 3	25	1"				10

#### 851/1 TZ SB bits



Code	EAN	+						
	4013288							
05073323001	029249	+	851/1 TZ PH	2x PH 1x25				5
05073324001	029256	+	851/1 TZ PH	2x PH 2x25				5
05073325001	029263	+	851/1 TZ PH	2x PH 3x25				5
05073326001	029270	+	851/1 TZ PH	1x PH 1x25; 1x PH 2x25; 1x PH 3x25				5

### 853/1 TZ ACR® bits

Bits with Torsion zone: where kinetic energy is diverted from peak loads. This greatly extends the product service life. Come with rough ribs (anti cam-out feature, ACR).

Tough viscous, for universal use; 1/4" hexagon, suitable for holders as per DIN ISO 1173-D 6.3.

#### 853/1 TZ ACR® bits



	EAN	+	⌀	ℓ				
Code	4013288		mm					
05056662001	014405	PH 2	25	1"				10

### 851/1 Z bits

- Ductile and tough for hard materials

#### 851/1 Z bits



	EAN	+	⌀	ℓ				
Code	4013288		mm					
05056500001	013323	PH 0	25	1"				10
05072070001	013453	PH 1	25	1"				10
05056507001	013330	PH 1	50	2"				10
05072072001	013460	PH 2	25	1"				10
05056515001	013347	PH 2	32	1 1/4"				10
05056520001	013354	PH 2	50	2"				10
05072074001	013477	PH 3	25	1"				10
05134905001	094858	PH 3	50	2"				10
05056535001	013378	PH 4	32	1 1/4"				10

#### 851/1 Z SB bits



Code	EAN	+						
	4013288							
05073304001	029058	+	851/1 Z PH	2x PH 1x25				5
05073305001	029065	+	851/1 Z PH	2x PH 2x25				5
05073306001	029072	+	851/1 Z PH	2x PH 3x25				5
05073307001	029089	+	851/1 Z PH	1x PH 1x25; 1x PH 2x25; 1x PH 3x25				5

#### 851/1 Z DIY bits



Code	EAN	+						
	4013288							
05072400001	115737	+	851/1 Z PH	10x PH 1x25				1
05072401001	115744	+	851/1 Z PH	10x PH 2x25				1
05072402001	115751	+	851/1 Z PH	10x PH 3x25				1



### 851/1 Z DIY 100 bits



	<b>Code</b>	<b>EAN</b>		
	05072441001	4013288 138477	<b>851/1 Z PH</b> 100x PH 2x25	1

### Bit-Box 20 PH



	<b>Code</b>	<b>EAN</b>		
	05057750001	4013288 188014	<b>851/1 Z PH</b> 20x PH 2x25	20

### 851/1 J bits

Bits optimised for Asian PH screws. Similar to Camera screws. Tough viscous for universal use. 1/4" hexagon, suitable for holders as per DIN ISO 1173-D 6.3.

### 851/1 J bits



<b>Code</b>	<b>EAN</b>						
	4013288			mm		mm	
05135040001 <sup>1)</sup>	112569	PH 00	25	1"	2,0		10
05135041001 <sup>2)</sup>	112576	PH 0	25	1"	2,5		10

<sup>1)</sup>Size 00 modified according to JCIS 00 (Japanese Camera Industrial Standard)

<sup>2)</sup>Size 0 modified according to JCIS 0 (Japanese Camera Industrial Standard)

### Impaktor system - For an above-average service life

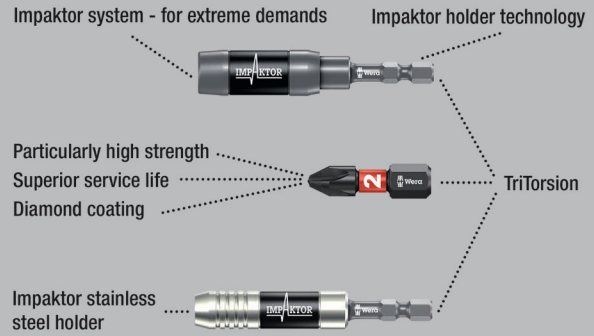

The Impaktor technology offers an above-average service life even under extreme circumstances. Enhanced friction resistance, thanks to the rough diamond-particle coating on the bit tip, prevents any slipping out of the screw head.

Particularly suitable for use with customary impact drivers. 1/4" hexagon, suitable for holders as per DIN ISO 1173-F 6.3.

### 851/4 IMP DC PH DIY Impaktor PH bits

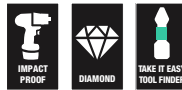

	<b>Code</b>	<b>EAN</b>		
	05057656001	4013288 157652	<b>851/4 IMP DC</b> 5x PH 2x50	1
	05057657001	157669	<b>851/4 IMP DC</b> 5x PH 3x50	1



### 851/4 IMP DC SB Impaktor bits



Code	EAN			
	4013288			
05073956001	158482		851/4 IMP DC 1x PH 2x50	5
05073957001	158499		851/4 IMP DC 1x PH 3x50	5

### Kraftform Stainless - stainless steel to prevent rust

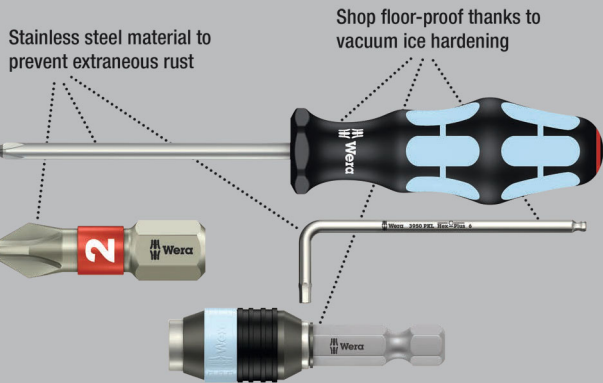

High quality bits out of stainless steel for cross-recess screws. Wera stainless are made out of stainless steel which prevents the formation of unsightly extraneous rust. 1/4" hexagon, suitable for holders as per DIN ISO 1173-F 6.3.

### 3851/4 Bits, stainless



Code	EAN		mm					
	4013288							
05071081001	115485	PH 1	89	3 1/2"				10
05071082001	115492	PH 2	89	3 1/2"				10
05071083001	115508	PH 3	89	3 1/2"				10

### BiTorsion system - for longer service life

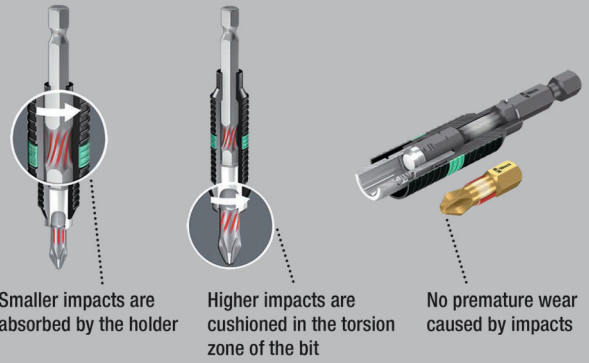

Smaller impacts are absorbed by the holder

Higher impacts are cushioned in the torsion zone of the bit

No premature wear caused by impacts

### 851/4 BDC bits

BiTorsion bits with tiny diamond particles on the bit tip. This ensures a secure fit of the bit in the screw, reduces the contact pressure required and lowers the risk of slipping.

Comes with Torsion zone – where kinetic energy is diverted from peak loads. This greatly extends the product service life; 1/4" hexagon, suitable for holders as per DIN ISO 1173-F 6.3.

### 851/4 BDC bits



Code	EAN		mm					
	4013288							
05059530001	034090	PH 1	50	2"				10
05059532001	034106	PH 2	50	2"				10
05059534001	034113	PH 3	50	2"				10

### 851/4 BTH bits

BiTorsion bits with Torsion zone – where kinetic energy is diverted from peak loads.

This greatly extends the product service life; 1/4" hexagon, suitable for holders as per DIN ISO 1173-F 6.3.

#### 851/4 BTH bits



	EAN	+	⌀	ℓ				
<b>Code</b>	4013288		mm					
05059540001	034304	PH 1	50	2"				10
05059542001	034311	PH 2	50	2"				10
05059544001	034328	PH 3	50	2"				10

### 851/4 BTZ bits

BiTorsion with Torsion zone – where kinetic energy is diverted from peak loads.

This greatly extends the product service life. Tough viscous for universal use; 1/4" hexagon, suitable for holders as per DIN ISO 1173-F 6.3.

#### 851/4 BTZ bits



	EAN	+	⌀	ℓ				
<b>Code</b>	4013288		mm					
05059550001	034571	PH 1	50	2"				10
05059552001	034588	PH 2	50	2"				10
05059554001	034595	PH 3	50	2"				10

### 851/4 RH Reduced tip bits

Bits with reduced shaft diameter for low-lying screw connections, enabling countersinking of screws without any surface damage. Profiled version. Extra-hard. 1/4" hexagon, suitable for holders as per DIN ISO 1173-F 6.3.

#### 851/4 RH Reduced tip bits



	EAN	+	⌀	ℓ	ℓ	∅		
<b>Code</b>	4013288		mm			mm		
05380161001	157065	PH 2	50	2"	4,2			10

### 851/4 A bits

The sharp-edged profile ensures a dependable transfer of power between the bit and screw by breaking off the paint e.g. when screw profiles are covered in it.

Extra-hard design: 1/4" hexagon, suitable for holders as per DIN ISO 1173-F 6.3.

#### 851/4 A bits



	EAN	+	⌀	ℓ	ℓ	∅		
<b>Code</b>	4013288		mm			mm		
05134929001	105165	PH 0	50	2"	3			10
05134906001	105141	PH 0	70	2 3/4"	3			10
05134907001	105172	PH 0	89	3 1/2"	3			10
05134930001	100009	PH 1	50	2"	4,5			10
05134370001	037831	PH 1	70	2 3/4"	4,5			10
05134372001	037855	PH 1	89	3 1/2"	4,5			10
05134931001	100016	PH 2	50	2"	6			10
05134371001	037848	PH 2	70	2 3/4"	6			10
05134373001	037862	PH 2	89	3 1/2"	6			10
05134910001 <sup>1)</sup>	105202	PH 2	152	6"	6			10
05134911001 <sup>2)</sup>	105219	PH 2	152	6"	6			10
05134932001	100023	PH 3	50	2"	-			10
05134913001	105233	PH 3	70	2 3/4"	8			10
05134914001	105240	PH 3	89	3 1/2"	8			10
05134915001	105257	PH 3	152	6"	8			10
05160983001	106575	PH 4	50	2"	10			10

<sup>1)</sup>Length of drive 100 mm  
<sup>2)</sup>Length of drive 20 mm



### 851/4 R Reduced tip bits

High quality bits with reduced shaft diameter for low-lying screw connections, enabling countersinking of screws without any surface damage. Profiled version. Extra-hard. 1/4" hexagon, suitable for holders as per DIN ISO 1173-F 6.3.

#### 851/4 R Reduced tip bits



Code	EAN	+	1"	2"	3,0		
Code	EAN	+	mm		mm		
05160899001	105547	PH 2	50	2"	3,0		10
05160896001	105554	PH 2	152	6"	3,0		10

### 851/4 TH bits

High quality bits with Torsion zone – where kinetic energy is diverted from peak loads. This greatly extends the product service life. Extra-hard; 1/4" hexagon, suitable for holders as per DIN ISO 1173-F 6.3.

#### 851/4 TH bits



Code	EAN	+	1"	2"			
Code	EAN	+	mm				
05059855001	013897	PH 1	50	2"			10
05059860001	013903	PH 2	50	2"			10
05059865001	013910	PH 3	50	2"			10

### 851/4 TZ bits

Bits with Torsion zone – where kinetic energy is diverted from peak loads. This greatly extends the product service life. Tough viscous, for universal use. 1/4" hexagon, suitable for holders as per DIN ISO 1173-F 6.3.

#### 851/4 TZ bits



Code	EAN	+	1"	2"			
Code	EAN	+	mm				
05059805001	013927	PH 1	50	2"			10
05059810001	013934	PH 2	50	2"			10
05059815001	013941	PH 3	50	2"			10

### 851/4 TZ SB bits



Code	EAN	+				
Code	EAN	+				
05134380001	4013288 037947	+				
05134381001	037954	+	851/4 TZ PH	2x PH 1x50		3
05134382001	037961	+	851/4 TZ PH	2x PH 2x50		3
				2x PH 3x50		3

### 851/4 Z bits

Tough viscous for universal use. 1/4" hexagon, suitable for holders as per DIN ISO 1173-F 6.3.

#### 851/4 Z bits



Code	EAN	+	1"	2"	3"		
Code	EAN	+	mm		mm		
05059755001	013781	PH 1	70	2 3/4"	4,5		10
05059760001	013798	PH 1	89	3 1/2"	4,5		10
05059765001	031044	PH 1	127	5"	4,5		10
05059766001	031051	PH 1	152	6"	4,5		10
05059770001	013804	PH 2	70	2 3/4"	6,0		10
05059775001	013811	PH 2	89	3 1/2"	6,0		10
05059780001	013828	PH 2	110	4 3/8"	6,0		10
05059785001	030474	PH 2	127	5"	6,0		10
05059786001	031068	PH 2	152	6"	6,0		10
05059790001	013835	PH 3	70	2 3/4"	-		10
05059795001	013842	PH 3	89	3 1/2"	-		10
05059800001	013859	PH 3	110	4 3/8"	-		10
05059802001	031075	PH 3	152	6"	-		10

### 851/4 J bits

Bits optimised for Asian PH screws. In particular, for applications with very small dimensions pursuant to the Japanese Camera Industrial Standard.

Tough viscous for universal use. 1/4" hexagon, suitable for holders as per DIN ISO 1173-F 6.3.

#### 851/4 J bits



Code	EAN	+	mm	mm	mm			
05135530001 <sup>1)</sup>	113252	PH 00	50	2"	2,0			10
05380200001 <sup>1)</sup>	156204	PH 00	89	3 1/2"	2,0			10
05135531001 <sup>2)</sup>	113269	PH 0	50	2"	2,5			10
05380201001 <sup>2)</sup>	156211	PH 0	89	3 1/2"	2,5			10
05135532001	113276	PH 1	50	2"	4,5			10
05380202001	156228	PH 1	89	3 1/2"	4,5			10

<sup>1)</sup>Optimised for Asian PH screws

<sup>2)</sup>Size 0 modified according to JCS 0 (Japanese Camera Industrial Standard)

#### 851/4 Z SB bits



Code	EAN	+		
05073520001	105875	+	851/4 Z PH 1x PH 1x89	5
05136305001	213839	+	851/4 Z PH 1x PH 1x152	3
05073521001	105882	+	851/4 Z PH 1x PH 2x89	5
05136306001	213846	+	851/4 Z PH 1x PH 2x152	3
05073522001	105899	+	851/4 Z PH 1x PH 3x89	5
05136307001	213853	+	851/4 Z PH 1x PH 3x152	3

### 853/4 ACR® SL bits with sleeve, magnetized

Bits with rough ribs (anti cam-out feature, ACR) to prevent any slipping out of the screw head, permanently magnetized, thus screws can be held securely on the tip of the bit; with plastic sleeve, protects components from being damaged when screwdriving.

Tough viscous for universal use. 1/4" hexagon, suitable for holders as per DIN ISO 1173-F 6.3.

#### 853/4 ACR® SL bits with sleeve, magnetized



Code	EAN	+	mm	mm	mm			
05323780001	165190	PH 2	50	2"	5,2			40
05323781001	165206	PH 2	90	3 1/2"	5,2			40
05203913001	163189	PH 2	150	6"	5,2			40
05203914001	163196	PH 2	200	8"	5,2			60

### 853/4 ACR® bits

Bits with Torsion zone – where kinetic energy is diverted from peak loads. This greatly extends the product service life. Come with rough ribs (anti cam-out feature, ACR) to prevent any slipping out of the screw head.

Tough viscous for universal use. 1/4" hexagon, suitable for holders as per DIN ISO 1173-F 6.3.

#### 853/4 ACR® bits



Code	EAN	+	mm	mm	mm			
05346286001	105578	PH 2	50	2"	5,2			10



### 853/4 Harpoon ACR® bits

Bits with reduced shaft diameter for low-lying screw connections. Countersinking of screws without any surface damage. Come with rough ribs (anti cam-out feature, ACR) to prevent any slipping out of the screw head.

Tough viscous for universal use. 1/4" hexagon, suitable for holders as per DIN ISO 1173-F 6.3.

### 853/4 Harpoon ACR® bits



	EAN	+	⌀	⌀	⌀		
Code	4013288		mm		mm		
05160901001	105592	PH 2	50	2"	3,3		10
05160895001	105608	PH 2	70	2 3/4"	3,3		10
05160908001	105615	PH 2	152	6"	3,3		10

### 851/2 Z bits

For universal use. 5/16" hexagon, suitable for holders as per DIN ISO 1173-D 8.

### 851/2 Z bits



	EAN	+	⌀	⌀	⌀		
Code	4013288		mm		mm		
05057705001	013668	PH 1	32	1 1/4"	4,5		10
05057710001	013675	PH 2	32	1 1/4"	6,0		10
05057715001	013682	PH 3	32	1 1/4"	7,6		10
05057720001	013699	PH 4	32	1 1/4"	-		10

### 851/11 Bits

With thread drive M 4.

### 851/11 Bits



	EAN	+	⌀	⌀	⌀		
Code	4013288		mm		mm		
05065081001	014245	PH 2	33	1 1/4"	6,0		5

### 851/12 Bits

Tough viscous for universal use. Thread drive M 5.

### 851/12 Bits



	EAN	+	⌀	⌀	⌀		
Code	4013288		mm		mm		
05065110001	014252	PH 2	33	1 1/4"	7,0		5
05065112001	014269	PH 2	35	1 3/8"	7,0		5
05065114001	014276	PH 2	44,5	1 3/4"	6,0		5

### 851/16 bits

Thread drive #10-32 UNF.

### 851/16 bits



	EAN	+	⌀	⌀	⌀		
Code	4013288		mm		mm		
05065197001	014351	PH 2	44,5	1 3/4"	6,0		5

### 851/9 C J PH bits, halfmoon

With 4 mm halfmoon drive. Optimised for Japanese PH screws. Hard design.

### 851/9 C J PH bits, halfmoon



	EAN	+	⌀	⌀	⌀	⌀	⌀	
Code	4013288		mm		mm	mm		
05134605001 <sup>1)</sup>	190444	PH 000	44	1 47/64"	1,5	20	25/32"	10
05135270001 <sup>1)</sup>	112729	PH 00	44	1 47/64"	1,8	20	25/32"	10
05135271001 <sup>1)</sup>	112736	PH 00	64	2 33/64"	1,8	20	25/32"	10
05135272001 <sup>2)</sup>	112743	PH 0	44	1 47/64"	1,8	20	25/32"	10
05135273001 <sup>2)</sup>	112750	PH 0	64	2 33/64"	1,8	20	25/32"	10
05135276001 <sup>1)</sup>	112781	PH 1	44	1 47/64"	3,0	20	25/32"	10
05135277001 <sup>1)</sup>	112798	PH 1	64	2 33/64"	3,0	20	25/32"	10

<sup>1)</sup> Optimised for Asian PH screws

<sup>2)</sup> Size 0 modified according to JCS 0 (Japanese Camera Industrial Standard)

## 851/21 J bits

With HIOS 4 mm drive. Optimised for Japanese PH screws.  
Hard design.

### 851/21 J bits



Code	EAN	+	mm	mm	mm		
05135280001 <sup>1)</sup>	112804	PH 00	40	1 9/16"	1,8		10
05135281001 <sup>1)</sup>	112811	PH 00	60	2 3/8"	1,8		10
05135284001 <sup>2)</sup>	112828	PH 0	40	1 9/16"	1,8		10
05135285001 <sup>2)</sup>	112835	PH 0	60	2 3/8"	1,8		10

<sup>1)</sup>Size 00 modified according to JCIS 00 (Japanese Camera Industrial Standard)

<sup>2)</sup>Size 0 modified according to JCIS 0 (Japanese Camera Industrial Standard)

## Impaktor system - For an above-average service life

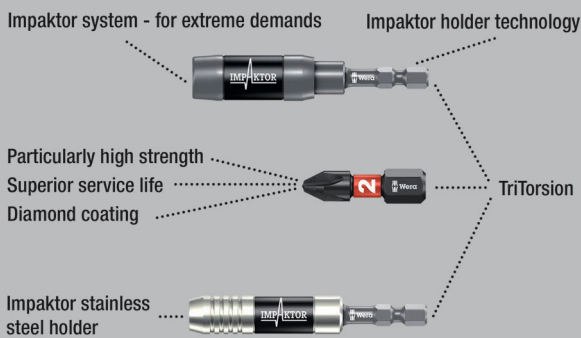

High quality bits for Pozidriv screws. The Impaktor technology offers an above-average service life even under extreme circumstances. Enhanced friction resistance, thanks to the rough diamond-particle coating on the bit tip, prevents any slipping out of the screw head. Particularly suitable for use with customary impact drivers. 1/4" hexagon, suitable for holders as per DIN ISO 1173-D 6.3.

### 855/1 IMP DC PZ DIY Impaktor bits



Code	EAN	+		
05057620001	178718	+	855/1 IMP DC 10x PZ 1x25	1
05057621001	157676	+	855/1 IMP DC 10x PZ 2x25	1
05057622001	157683	+	855/1 IMP DC 10x PZ 3x25	1

### 855/1 IMP DC SB Impaktor bits



Code	EAN	+		
05073921001	158383	+	855/1 IMP DC 1x PZ 2x25	5
05073922001	158390	+	855/1 IMP DC 1x PZ 3x25	5

### Bit-Box 15 Impaktor PZ



Code	EAN	+		
05057763001	187901	+	855/1 IMP DC 15x PZ 2x25	10



## Kraftform Stainless - stainless steel to prevent rust

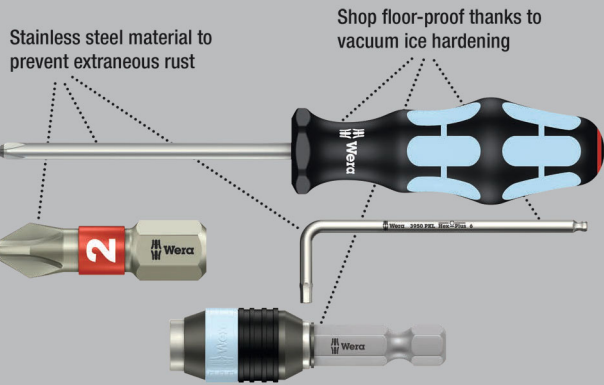

High quality bits out of stainless steel for Pozidriv screws. Wera stainless are made out of stainless steel which prevents the formation of unsightly extraneous rust. Come with Torsion zone: Torsion bits take-up torque peaks and absorb them in the Torsion zone. This prevents premature wear and extends the service life of the bit. 1/4" hexagon, suitable for holders as per DIN ISO 1173-D 6.3.

### 3855/1 TS bits, stainless



	EAN	✳	⌀	ℓ					
Code	4013288		mm						
05071020001	111012	PZ 1	25	1"					10
05071021001	111029	PZ 2	25	1"					10
05071022001	111036	PZ 3	25	1"					10

### 3855/1 TS SB bits, stainless



Code	EAN	✳							
	4013288								
05073613001	112101	✳	3855/1 TS PZ						5
			1x PZ 1x25						
05073614001	112118	✳	3855/1 TS PZ						5
			1x PZ 2x25						
05073615001	112125	✳	3855/1 TS PZ						5
			1x PZ 3x25						

## BiTorsion system - for longer service life

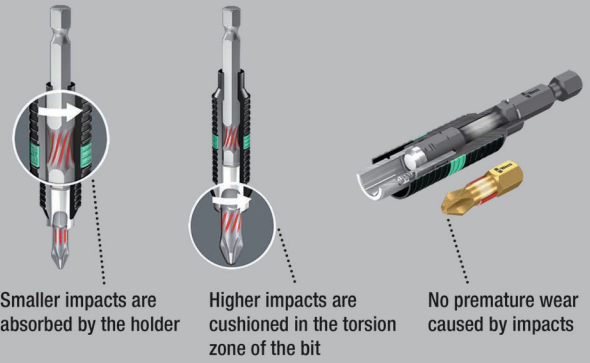

### 855/1 BDC bits

BiTorsion bits with tiny diamond particles on the bit tip. This ensures a secure fit of the bit in the screw, reduces the contact pressure required and lowers the risk of slipping.

Comes with Torsion zone – where kinetic energy is diverted from peak loads. This greatly extends the product service life; 1/4" hexagon, suitable for holders as per DIN ISO 1173-D 6.3.

### 855/1 BDC bits



	EAN	✳	⌀	ℓ					
Code	4013288		mm						
05056700001	034007	PZ 1	25	1"					10
05056702001	034014	PZ 2	25	1"					10
05056704001	034021	PZ 3	25	1"					10



### 855/1 BDC SB bits



Code	EAN			
05073336001	029362	+	855/1 BDC PZ 1x PZ 1x25	5
05073337001	029379	+	855/1 BDC PZ 1x PZ 2x25	5
05073338001	029386	+	855/1 BDC PZ 1x PZ 3x25	5
05073339001	029393	+	855/1 BDC PZ 2x PZ 2x25	5

### 855/1 BTH bits

BiTorsion bits with Torsion zone – where kinetic energy is diverted from peak loads.

This greatly extends the product service life. This provides the best possible durability together with the matching holder.

Extra-hard; 1/4" hexagon, suitable for holders as per DIN ISO 1173-D 6.3.

### 855/1 BTH bits



Code	EAN	+	mm	1"				
05056710001	034274	PZ 1	25	1"				10
05056712001	034281	PZ 2	25	1"				10
05056714001	034298	PZ 3	25	1"				10

### Bit-Box 20 BTH PZ



Code	EAN	+		
05057762001	187963	+	855/1 BTH PZ 20x PZ 2x25	10

### 855/1 BTZ bits

BiTorsion bits with Torsion zone – where kinetic energy is diverted from peak loads.

This greatly extends the product service life.

Tough, for universal use; 1/4" hexagon, suitable for holders as per DIN ISO 1173-D 6.3.

### 855/1 BTZ bits



Code	EAN	+	mm	1"				
05056720001	034489	PZ 1	25	1"				10
05056722001	034496	PZ 2	25	1"				10
05056724001	034502	PZ 3	25	1"				10

### Bit-Box 20 BTZ PZ



Code	EAN	+		
05057761001	187970	+	855/1 BTZ PZ 20x PZ 2x25	10



### 855/1 RZ bits

Reduced shaft diameter for low-lying screw connections. Countersinking of screws without any surface damage. Especially for drywall construction and suitable for drywall screws.

#### 855/1 RZ bits



	EAN					
<b>Code</b>	4013288		mm		mm	
05135017001	175311	PZ 1	25	1"	4,2	10
05135003001	096739	PZ 2	25	1"	4,2	10

### 855/1 TH bits

With Torsion zone – where kinetic energy is diverted from peak loads. This greatly extends the product service life. Extra-hard; 1/4" hexagon, suitable for holders as per DIN ISO 1173-D 6.3.

#### 855/1 TH bits



	EAN					
<b>Code</b>	4013288		mm			
05056910001	014740	PZ 1	25	1"		10
05056915001	014757	PZ 2	25	1"		10
05056925001	014764	PZ 3	25	1"		10

#### 855/1 TH SB bits



	EAN					
<b>Code</b>	4013288					
05073370001	029638		855/1 TH PZ	2x PZ 1x25		5
05073371001	029645		855/1 TH PZ	2x PZ 2x25		5
05073372001	029652		855/1 TH PZ	2x PZ 3x25		5
05073373001	029669		855/1 TH PZ	1x PZ 1x25; 1x PZ 2x25; 1x PZ 3x25		5

### 855/1 TiN bits

With extra-hard titanium nitride (TiN) coating for withstanding permanent loads such as e.g. in industrial applications.

1/4" hexagon, suitable for holders as per DIN ISO 1173-D 6.3.

#### 855/1 TiN bits



	EAN					
<b>Code</b>	4013288		mm			
05480222001	041029	PZ 2	25	1"		10

### 855/1 TZ bits

With Torsion zone to combat premature wear.

Tough viscous for universal use. 1/4" hexagon, suitable for holders as per DIN ISO 1173-D 6.3.

#### 855/1 TZ bits



	EAN					
<b>Code</b>	4013288		mm			
05056810001	014801	PZ 1	25	1"		10
05056815001	014818	PZ 2	25	1"		10
05056825001	014825	PZ 3	25	1"		10

### 855/1 Z bits

Tough viscous for universal use. 1/4" hexagon, suitable for holders as per DIN ISO 1173-D 6.3.

#### 855/1 Z bits



	EAN					
<b>Code</b>	4013288		mm			
05056805001	014535	PZ 0	25	1"		10
05072080001	014658	PZ 1	25	1"		10
05056812001	014542	PZ 1	50	2"		10
05072082001	014665	PZ 2	25	1"		10
05056820001	014559	PZ 2	50	2"		10
05072084001	014672	PZ 3	25	1"		10
05056835001	014573	PZ 4	32	1 1/4"		10

### 855/1 Z SB bits



Code	EAN		
05073308001	029096	855/1 Z PZ 2x PZ 1x25	5
05073309001	029102	855/1 Z PZ 2x PZ 2x25	5
05073310001	029119	855/1 Z PZ 2x PZ 3x25	5
05073380001	029621	855/1 Z PZ 1x PZ 4x32	5
05073311001	029126	855/1 Z PZ 1x PZ 1x25; 1x PZ 2x25; 1x PZ 3x25	5

### 855/1 Z DIY bits



Code	EAN		
05072403001	115768	855/1 Z PZ 10x PZ 1x25	1
05072404001	115775	855/1 Z PZ 10x PZ 2x25	1
05072405001	115782	855/1 Z PZ 10x PZ 3x25	1

### 855/1 Z DIY 100 bits



Code	EAN		
05072443001	138484	855/1 Z PZ 100x PZ 1x25	1
05072444001	138491	855/1 Z PZ 100x PZ 2x25	1

### Bit-Box 20 PZ



Code	EAN		
05057760001	188052	855/1 Z PZ 20x PZ 2x25	20

### Impaktor system - For an above-average service life

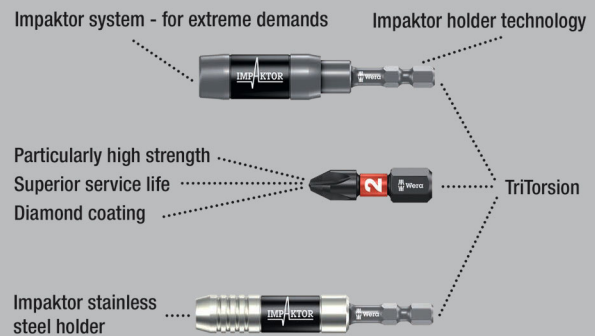

The Impaktor technology offers an above-average service life even under extreme circumstances. Enhanced friction resistance, thanks to the rough diamond-particle coating on the bit tip, prevents any slipping out of the screw head.

Particularly suitable for use with customary impact drivers. 1/4" hexagon, suitable for holders as per DIN ISO 1173-F 6.3.

### 855/4 IMP DC PZ DIY Impaktor bits



Code	EAN		
05057661001	157690	855/4 IMP DC 5x PZ 2x50	1
05057662001	157706	855/4 IMP DC 5x PZ 3x50	1

### 855/4 IMP DC Impaktor bits SB



Code	EAN		
	4013288		
05073961001	158505		855/4 IMP DC 1x PZ 2x50
05073962001	158512		855/4 IMP DC 1x PZ 3x50

### Kraftform Stainless - stainless steel to prevent rust

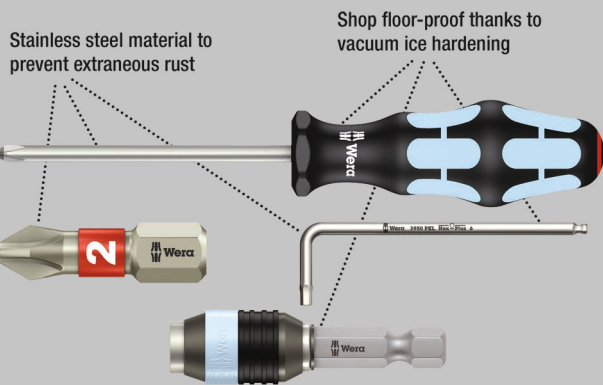

High quality bits out of stainless steel which prevents the formation of unsightly extraneous rust. 1/4" hexagon, suitable for holders as per DIN ISO 1173-F 6.3.

### 3855/4 bits, stainless



Code	EAN							
	4013288			mm				
05071084001	115515			89	3 1/2"			10
05071085001	115522			89	3 1/2"			10
05071086001	115539			89	3 1/2"			10

### BiTorsion system - for longer service life

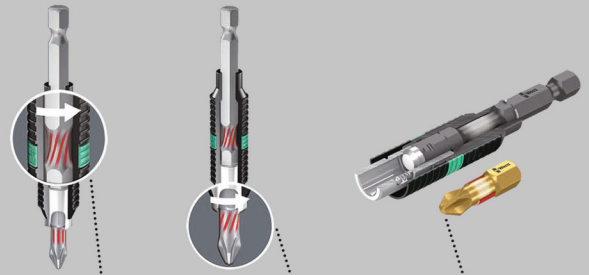

Smaller impacts are absorbed by the holder

Higher impacts are cushioned in the torsion zone of the bit

No premature wear caused by impacts

### 855/4 BDC bits

Bits with tiny diamond particles on the bit tip. This ensures a secure fit of the bit in the screw, reduces the contact pressure required and lowers the risk of slipping.

Comes with Torsion zone – where kinetic energy is diverted from peak loads. This greatly extends the product service life; 1/4" hexagon, suitable for holders as per DIN ISO 1173-F 6.3.

### 855/4 BDC bits



Code	EAN							
	4013288			mm				
05059900001	034120			50	2"			10
05059902001	034137			50	2"			10
05059904001	034144			50	2"			10

### 855/4 BTH bits

Bits with Torsion zone – where kinetic energy is diverted from peak loads. This greatly extends the product service life. This provides the best possible durability together with the matching holder.

Extra-hard; 1/4" hexagon, suitable for holders as per DIN ISO 1173-F 6.3.

### 855/4 BTH bits

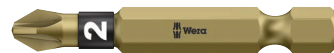

Code	EAN							
	4013288			mm				
05059910001	034335			50	2"			10
05059912001	034342			50	2"			10
05059914001	034359			50	2"			10

### 855/4 BTZ bits

BiTorsion bits with Torsion zone – where kinetic energy is diverted from peak loads. This greatly extends the product service life.

Tough viscous for universal use; 1/4" hexagon, suitable for holders as per DIN ISO 1173-F 6.3.

#### 855/4 BTZ bits



	EAN		⌀	ℓ				
<b>Code</b>	4013288		mm					
05059920001	034601	PZ 1	50	2"				10
05059922001	034618	PZ 2	50	2"				10
05059924001	034625	PZ 3	50	2"				10

### 855/4 TH bits

Bits with Torsion zone – where kinetic energy is diverted from peak loads. This greatly extends the product service life. Extra-hard; 1/4" hexagon, suitable for holders as per DIN ISO 1173-F 6.3.

#### 855/4 TH bits



	EAN		⌀	ℓ				
<b>Code</b>	4013288		mm					
05060055001	015068	PZ 1	50	2"				10
05060060001	015075	PZ 2	50	2"				10
05060065001	015082	PZ 3	50	2"				10

### 855/4 TZ bits

High quality bits with Torsion zone – where kinetic energy is diverted from peak loads.

This greatly extends the product service life. Tough viscous, for universal use. 1/4" hexagon, suitable for holders as per DIN ISO 1173-F 6.3.

#### 855/4 TZ bits



	EAN		⌀	ℓ				
<b>Code</b>	4013288		mm					
05060005001	015099	PZ 1	50	2"				10
05060010001	015105	PZ 2	50	2"				10
05060015001	015112	PZ 3	50	2"				10

#### 855/4 TZ SB bits



	EAN				
<b>Code</b>	4013288				
05134384001	037985		<b>855/4 TZ PZ</b> 2x PZ 1x50		3
05134385001	037992		<b>855/4 TZ PZ</b> 2x PZ 2x50		3
05134386001	038005		<b>855/4 TZ PZ</b> 2x PZ 3x50		3



### 855/4 Z bits

Tough viscous for universal use. 1/4" hexagon, suitable for holders as per DIN ISO 1173-F 6.3.

#### 855/4 Z bits



Code	EAN						
			mm		mm		
05060027001	014955	PZ 1	70	2 3/4"	4,5		10
05060029001	014962	PZ 1	89	3 1/2"	4,5		10
05060031001	031426	PZ 1	127	5"	4,5		10
05060030001	031259	PZ 1	152	6"	4,5		10
05060033001	014979	PZ 2	70	2 3/4"	6,0		10
05060035001	014986	PZ 2	89	3 1/2"	6,0		10
05060037001	014993	PZ 2	110	4 3/8"	6,0		10
05060036001	031440	PZ 2	127	5"	6,0		10
05060038001	031297	PZ 2	152	6"	6,0		10
05060041001	015006	PZ 3	70	2 3/4"	-		10
05060043001	015013	PZ 3	89	3 1/2"	-		10
05060045001	015020	PZ 3	110	4 3/8"	-		10
05060047001	031433	PZ 3	152	6"	-		10

#### 855/4 Z SB bits



Code	EAN			
05073523001	105905		855/4 Z PZ 1x PZ 1x89	5
05073524001	106452		855/4 Z PZ 1x PZ 2x89	5
05073525001	105912		855/4 Z PZ 1x PZ 3x89	5
05136308001	213860		855/4 Z PZ 1x PZ 1x152	3
05136309001	213877		855/4 Z PZ 1x PZ 2x152	3
05136310001	213884		855/4 Z PZ 1x PZ 3x152	3

### 855/2 Z bits

5/16" hexagon, suitable for holders as per DIN ISO 1173-D 8.

#### 855/2 Z bits



Code	EAN						
			mm		mm		
05058005001	014863	PZ 1	32	1 1/4"	4,5		10
05058010001	014870	PZ 2	32	1 1/4"	6,0		10
05058015001	014887	PZ 3	32	1 1/4"	7,6		10
05058020001	014894	PZ 4	32	1 1/4"	-		10

### 855/11 bits

With thread drive M 4.

#### 855/11 bits



Code	EAN						
			mm		mm		
05065096001	015426	PZ 2	33	1 1/4"	6,0		5

### 855/12 bits

With thread drive M 5.

#### 855/12 bits



Code	EAN						
			mm		mm		
05065129001	015457	PZ 2	44,5	1 3/4"	6,0		5

### 851/4 PH/S PlusMinus bits

Bits with combination profile Phillips/slotted. In electrical applications screws with mixed geometry (slotted and Phillips cross-recess) are quite common.

Bits having a PlusMinus profile are optimum for addressing these screws. Tough viscous for universal use. 1/4" hexagon, suitable for holders as per DIN ISO 1173-F 6.3.

#### 851/4 PH/S PlusMinus bits



Code	EAN						
			mm		mm		
05059720001	102577	# 1	70	2 3/4"	4,5		10
05059721001	102584	# 2	70	2 3/4"	6		10

### 855/4 PZ/S PlusMinus bits

Bits with combination profile slotted and Pozidriv, particularly for jobs on terminal blocks, fuse boxes, switches and relays.

Tough viscous for universal use. 1/4" hexagon, suitable for holders as per DIN ISO 1173-F 6.3.

### 855/4 PZ/S PlusMinus bits



	EAN						
Code	4013288		mm		mm		
05059896001	102591	# 1	70	2 3/4"	4,5		10
05059897001	102607	# 2	70	2 3/4"	6		10

### Impaktor system - For an above-average service life

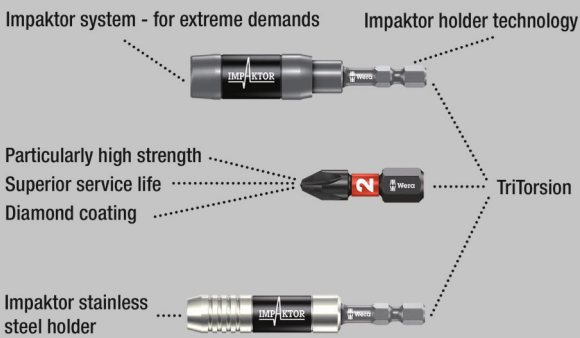

High quality bits for recessed TORX® screws. The Impaktor technology offers an above-average service life even under extreme circumstances. Enhanced friction resistance, thanks to the rough diamond-particle coating on the bit tip, prevents any slipping out of the screw head.

Particularly suitable for use with customary impact drivers. 1/4" hexagon, suitable for holders as per DIN ISO 1173-D 6.3.

### 867/1 IMP DC TORX® DIY Impaktor bits



Code	EAN			
	4013288			
05057628001	178688		867/1 IMP DC 10x TX 10x25	1
05057623001	169242		867/1 IMP DC 10x TX 15x25	1
05057624001	163165		867/1 IMP DC 10x TX 20x25	1
05057625001	157447		867/1 IMP DC 10x TX 25x25	1
05057626001	157454		867/1 IMP DC 10x TX 30x25	1
05057627001	157461		867/1 IMP DC 10x TX 40x25	1

### 867/1 IMP DC SB Impaktor bits



Code	EAN			
	4013288			
05073924001	163240		867/1 IMP DC 1x TX 20x25	5
05073925001	158406		867/1 IMP DC 1x TX 25x25	5
05073926001	158413		867/1 IMP DC 1x TX 30x25	5
05073927001	158420		867/1 IMP DC 1x TX 40x25	5

### Bit-Box 15 Impaktor TX



Code	EAN			
	4013288			
05057772001	187871		867/1 IMP DC 15x TX 20x25	10
05057775001	187888		867/1 IMP DC 15x TX 25x25	10
05057776001	187895		867/1 IMP DC 15x TX 30x25	10



## Kraftform Stainless - stainless steel to prevent rust

Stainless steel material to prevent extraneous rust

Shop floor-proof thanks to vacuum ice hardening

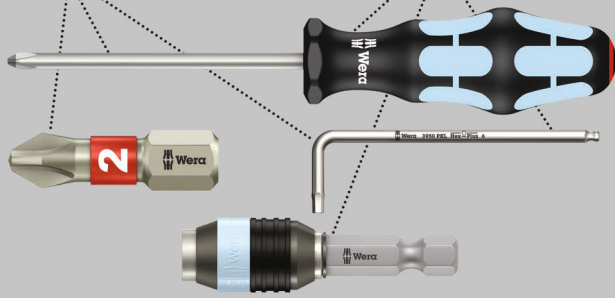

High quality bits out of stainless steel for recessed TORX® screws. Prevent the formation of unsightly extraneous rust.

Come with Torsion zone: Torsion bits take-up torque peaks and absorb them in the Torsion zone. This prevents premature wear and extends the service life of the bit. 1/4" hexagon, suitable for holders as per DIN ISO 1173-D 6.3.

### 3867/1 TS TORX® bits, stainless



Code	EAN		mm	inch				
05071030001	111043	TX 8	25	1"				10
05071032001	111067	TX 10	25	1"				10
05071033001	111074	TX 15	25	1"				10
05071034001	111081	TX 20	25	1"				10
05071035001	111098	TX 25	25	1"				10
05071037001	111111	TX 30	25	1"				10
05071038001	111128	TX 40	25	1"				10

### 3867/1 TS SB TORX® bits, stainless

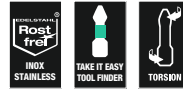

Code	EAN			
05073620001	117670		3867/1 TS TORX® 1x TX 10x25	5
05073621001	117687		3867/1 TS TORX® 1x TX 15x25	5
05073622001	117694		3867/1 TS TORX® 1x TX 20x25	5
05073623001	117700		3867/1 TS TORX® 1x TX 25x25	5
05073625001	117724		3867/1 TS TORX® 1x TX 30x25	5

### BiTorsion system - for longer service life

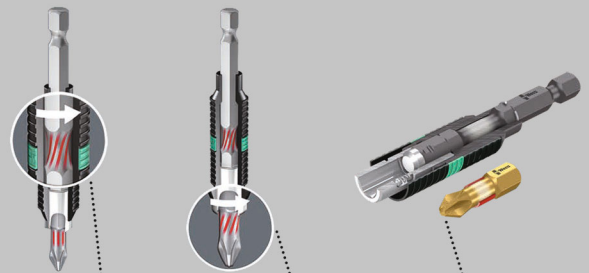

Smaller impacts are absorbed by the holder

Higher impacts are cushioned in the torsion zone of the bit

No premature wear caused by impacts

### 867/1 BDC TORX® bits

Bits with tiny diamond particles on the bit tip. This ensures a secure fit of the bit in the screw, reduces the contact pressure required and lowers the risk of slipping.

Come with a Torsion zone – where kinetic energy is diverted from peak loads. This greatly extends the product service life. 1/4" hexagon, suitable for holders as per DIN ISO 1173-D 6.3.



### 867/1 BDC TORX® bits



	EAN								
Code	4013288		mm						
05066100001	034038	TX 10	25	1"					10
05066102001	034045	TX 15	25	1"					10
05066104001	034052	TX 20	25	1"					10
05066106001	034069	TX 25	25	1"					10
05066108001	034076	TX 30	25	1"					10
05066110001	034083	TX 40	25	1"					10

### 867/1 BDC SB TORX® bits

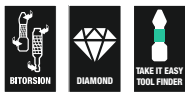

	EAN								
Code	4013288								
05134374001	099778		867/1 TORX® BDC	1x TX 10x25					5
05134375001	099785		867/1 TORX® BDC	1x TX 15x25					5
05134376001	099792		867/1 TORX® BDC	1x TX 20x25					5
05134377001	099808		867/1 TORX® BDC	1x TX 25x25					5
05134378001	099822		867/1 TORX® BDC	1x TX 30x25					5
05134379001	099815		867/1 TORX® BDC	1x TX 40x25					5

### 867/1 BTZ TORX® bits

BiTorsion bits with an Torsion zone – where kinetic energy is diverted from peak loads. This greatly extends the product service life. This provides the best possible durability together with the matching holder.

Tough viscous for universal use. 1/4" hexagon, suitable for holders as per DIN ISO 1173-D 6.3.

### 867/1 BTZ TORX® bits



	EAN								
Code	4013288		mm						
05066120001	034519	TX 10	25	1"					10
05066122001	034526	TX 15	25	1"					10
05066124001	034533	TX 20	25	1"					10
05066126001	034540	TX 25	25	1"					10
05066128001	034557	TX 30	25	1"					10
05066130001	034564	TX 40	25	1"					10

### 867/1 TORX® HF bits with holding function

- For TORX® socket screws
- Holding function for recessed TORX® screws
- Also suitable for Würth ASSY screws as well as Altenloh SPAX T-STAR plus screws
- 1/4" hexagon drive (Wera connecting series 1)
- With Take it easy tool finder: colour coding by size

### 867/1 TORX® HF bits with holding function



	EAN								
Code	4013288		mm						
05066140001	226334	TX 10	25	1"					10
05066141001	226341	TX 15	25	1"					10
05066142001	226365	TX 20	25	1"					10
05066143001	226358	TX 25	25	1"					10
05066144001	226389	TX 30	25	1"					10
05066145001 <sup>1)</sup>	226655	TX 40	25	1"					10

<sup>1)</sup>Pound-thru hexagonal; no Take it easy.



### Bit-Box 20 TX HF



Code	EAN			
	4013288			
0505777001	226013		<b>867/1 TORX® HF</b> 20x TX 20x25	20
05057778001	226020		<b>867/1 TORX® HF</b> 20x TX 25x25	20

### 867/1 TZ TORX® bits

With a Torsion zone – where kinetic energy is diverted from peak loads. This greatly extends the product service life.

Tough viscous for universal use. 1/4" hexagon, suitable for holders as per DIN ISO 1173-D 6.3.

### 867/1 TZ TORX® bits



Code	EAN							
Code	EAN		mm		mm			
05066300001	015709		TX 5	25	1"	4,2		10
05066301001	015716		TX 6	25	1"	4,2		10
05066302001	015723		TX 7	25	1"	4,2		10
05066303001	015730		TX 8	25	1"	4,2		10
05066304001	015747		TX 9	25	1"	4,2		10
05066305001	015754		TX 10	25	1"	4,2		10
05066308001	015761		TX 15	25	1"	4,2		10
05066310001	015778		TX 20	25	1"	4,8		10
05066312001	015785		TX 25	25	1"	5,5		10
05066313001	015792		TX 27	25	1"	5,5		10
05066315001	015808		TX 30	25	1"	6,0		10
05066320001	015815		TX 40	25	1"	-		10

### 867/1 TORX® bits



Code	EAN							
Code	EAN		mm		mm			
05135140001	107114		TX 1	25	1"	1,5		10
05135141001	107121		TX 2	25	1"	1,5		10
05135142001	111456		TX 3	25	1"	2,0		10
05135143001	111463		TX 4	25	1"	2,0		10
05066492001	030405		TX 5	25	1"	3,0		10
05066493001	030412		TX 6	25	1"	3,0		10
05066494001	030429		TX 7	25	1"	3,0		10
05066495001	030436		TX 8	25	1"	3,0		10
05066496001	030443		TX 9	25	1"	3,0		10
05066485001	030320		TX 10	25	1"	4,0		10
05066486001	030337		TX 15	25	1"	4,0		10
05066487001	030344		TX 20	25	1"	5,0		10
05066488001	030351		TX 25	25	1"	5,0		10
05066489001	030368		TX 27	25	1"	6,0		10
05066490001	030375		TX 30	25	1"	6,0		10
05066491001	030382		TX 40	25	1"	-		10
05066325001	031174		TX 45	35	1 3/8"	8,0		10
05066330001	031181		TX 50	35	1 3/8"	9,0		10
05066335001	031167		TX 55	35	1 3/8"	12,0		10

### 867/1 SB TORX® bits



Code	EAN			
	4013288			
05073313001	029140		<b>867/1 TORX®</b> 2x TX 10x25	5
05073340001	029591		<b>867/1 TORX®</b> 2x TX 15x25	5
05073314001	029157		<b>867/1 TORX®</b> 2x TX 20x25	5
05073315001	029164		<b>867/1 TORX®</b> 2x TX 25x25	5
05073316001	029171		<b>867/1 TORX®</b> 2x TX 30x25	5
05073317001	029188		<b>867/1 TORX®</b> 2x TX 40x25	5
05073346001	125859		<b>867/1 TORX®</b> 1x TX 50x35	5
05073375001	037503		<b>867/1 TORX®</b> 1x TX 10x25 1x TX 15x25 1x TX 20x25	5
05073376001	037510		<b>867/1 TORX®</b> 1x TX 25x25; 1x TX 30x25; 1x TX 40x25	5

## 867/1 DIY TORX® bits



Code	EAN			
	4013288			
05072406001	115799		<b>867/1 TORX®</b> 10x TX 10x25	1
05072407001	115805		<b>867/1 TORX®</b> 10x TX 15x25	1
05072408001	115812		<b>867/1 TORX®</b> 10x TX 20x25	1
05072409001	115829		<b>867/1 TORX®</b> 10x TX 25x25	1
05072411001	115843		<b>867/1 TORX®</b> 10x TX 30x25	1
05072412001	115850		<b>867/1 TORX®</b> 10x TX 40x25	1

## 867/1 TORX® DIY 100



Code	EAN			
	4013288			
05072446001	138507		<b>867/1 TORX®</b> 100x TX 10x25	1
05072447001	138514		<b>867/1 TORX®</b> 100x TX 15x25	1
05072448001	138521		<b>867/1 TORX®</b> 100x TX 20x25	1
05072449001	138538		<b>867/1 TORX®</b> 100x TX 25x25	1
05072451001	138552		<b>867/1 TORX®</b> 100x TX 30x25	1
05072452001	138569		<b>867/1 TORX®</b> 100x TX 40x25	1

## Bit-Box 20 TX



Code	EAN			
	4013288			
05057770001	187994		<b>867/1 TORX®</b> 20x TX 20x25	20
05057773001	188007		<b>867/1 TORX®</b> 20x TX 25x25	20

### 867/1 Z TORX® Wedge bits

The conical design of the profile means that a wedging effect is generated that holds the TORX® screw securely on the bit.

Tough viscous for universal use. 1/4" hexagon, suitable for holders as per DIN ISO 1173-D 6.3.

### 867/1 Z TORX® Wedge bits



Code	EAN								
	4013288								
05066455001	016034		TX 15	25	1"				10
05066460001	016041		TX 20	25	1"				10
05066465001	016058		TX 25	25	1"				10



### 867/1 ZA TORX® bits with central pin

Come with a pin which, together with the bore hole within the screw, makes it easier to centre the tool.

Tough viscous for universal use. 1/4" hexagon, suitable for holders as per DIN ISO 1173-D 6.3.

### 867/1 ZA TORX® bits with central pin



Code	EAN						
Code	EAN		mm	mm	mm		
05066081001	107190	TX 15	25	1"	4,0		10
05066082001	107206	TX 20	25	1"	5,0		10
05066083001	107213	TX 25	25	1"	5,0		10

### Impaktor system - For an above-average service life

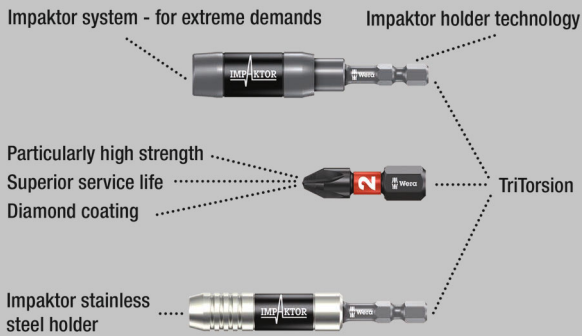

The Impaktor technology offers an above-average service life even under extreme circumstances. Enhanced friction resistance, thanks to the rough diamond-particle coating on the bit tip, prevents any slipping out of the screw head.

Particularly suitable for use with customary impact drivers. 1/4" hexagon, suitable for holders as per DIN ISO 1173-F 6.3.

### 867/4 IMP DC TORX® DIY Impaktor bits



Code	EAN			
Code	EAN			
05057664001	163172	867/4 IMP DC	5x TX 20x50	1
05057665001	157515	867/4 IMP DC	5x TX 25x50	1
05057666001	157522	867/4 IMP DC	5x TX 30x50	1
05057667001	157539	867/4 IMP DC	5x TX 40x50	1

### 867/4 IMP DC SB Impaktor bits

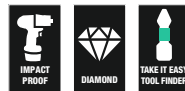

Code	EAN			
Code	EAN			
05073964001	163257	867/4 IMP DC	1x TX 20x50	5
05073965001	158529	867/4 IMP DC	1x TX 25x50	5
05073966001	158536	867/4 IMP DC	1x TX 30x50	5
05073967001	158543	867/4 IMP DC	1x TX 40x50	5

## TORX® Tools with holding function

Clamping force holds TORX® screw tight.



The TORX® HF (HF = holding function) specially developed by Wera distinguishes itself through the geometric optimisation of the original TORX® profile.

The wedging forces resulting from the contact pressure between the drive tip and the screw profile securely hold the screw on the tool! 1/4" hexagon, suitable for holders as per DIN ISO 1173-F 6.3.

### 867/4 TORX® HF bits with holding function

- For TORX® socket screws
- Holding function for recessed TORX® screws
- Also suitable for Würth ASSY screws as well as Altenloh SPAX T-STAR plus screws
- 1/4" hexagon drive (Wera connecting series 4)
- With Take it easy tool finder: colour coding by size

### 867/4 TORX® HF bits with holding function



	EAN						
Code	4013288		mm	mm	mm		
05060505001	226747	TX 8	50	2"	3,0		10
05060506001	226754	TX 10	50	2"	4,0		10
05060507001	226761	TX 15	50	2"	4,0		10
05060508001	226778	TX 20	50	2"	4,5		10
05060509001	226785	TX 25	50	2"	6,0		10
05060510001	226792	TX 30	50	2"	6,0		10
05060511001 <sup>1)</sup>	226808	TX 40	50	2"	-		10

<sup>1)</sup>Pound-thru hexagonal; no Take it easy.

## 867/4 KK TORX® bits

Ballpoint: the ballpoint drive profile means that it is possible to swivel the tool axis away from the screwdriving axis, thus enabling "round the corner" screwdriving. Tough viscous for universal use. 1/4" hexagon, suitable for holders as per DIN ISO 1173-F 6.3.

- 1/4" hexagon drive (Wera connecting series 4)

### 867/4 KK TORX® bits



	EAN						
Code	4013288		mm	mm	mm		
05059700001	155979	TX 10	89	3 1/2"			5
05059701001	155986	TX 15	89	3 1/2"			5
05059702001	155993	TX 20	89	3 1/2"			5
05059703001	156006	TX 25	89	3 1/2"			5
05059704001	156013	TX 30	89	3 1/2"			5
05059705001	156020	TX 40	89	3 1/2"			5



## 867/4 Z TORX® bits

Premium bits for TORX® socket screws. Tough, for universal use.  
1/4" hexagonal, suitable for holders as per DIN ISO 1173-F 6.3.

### 867/4 Z TORX® bits



Code	EAN						
Code	4013288		mm	mm	mm		
05135200001	107138	TX 1	50	2"	2,0		10
05135201001	107145	TX 2	50	2"	2,0		10
05135202001	112620	TX 3	50	2"	2,0		10
05135204001	041333	TX 4	50	2"	3,0		10
05135205001	031808	TX 5	50	2"	3,0		10
05308428001	041340	TX 6	50	2"	3,0		10
05134740001	035905	TX 6	70	2 3/4"	3,0		10
05332600001	033895	TX 6	89	3 1/2"	3,0		10
05328448001	038432	TX 6	152	6"	3,0		10
05160830001	113283	TX 7	50	2"	3,0		10
05345047001	128423	TX 7	70	2 3/4"	3,0		10
05060131001	030498	TX 8	50	2"	3,0		10
05060098001	030504	TX 8	70	2 3/4"	3,0		10
05060185001	030511	TX 8	89	3 1/2"	3,0		10
05060195001	030528	TX 8	152	6"	3,0		10
05319835001	128430	TX 9	70	2 3/4"	3,0		10
05060193001	155566	TX 9	89	3 1/2"	3,0		10
05060194001	156945	TX 9	152	6"	3,0		10
05060132001	030535	TX 10	50	2"	4,0		10
05060100001	016171	TX 10	70	2 3/4"	4,0		10
05060186001	030481	TX 10	89	3 1/2"	4,0		10
05060196001	030542	TX 10	152	6"	4,0		10
05060133001	030559	TX 15	50	2"	4,0		10
05060105001	016188	TX 15	70	2 3/4"	4,0		10
05060187001	030566	TX 15	89	3 1/2"	4,0		10
05060197001	030573	TX 15	152	6"	4,0		10
05060134001	030580	TX 20	50	2"	4,5		10
05060110001	016195	TX 20	70	2 3/4"	4,5		10
05060188001	030597	TX 20	89	3 1/2"	4,5		10
05060198001	030603	TX 20	152	6"	4,5		10
05060135001	030610	TX 25	50	2"	6,0		10
05060115001	016201	TX 25	70	2 3/4"	6,0		10
05060189001	030627	TX 25	89	3 1/2"	6,0		10
05060199001	030634	TX 25	152	6"	6,0		10
05060136001	030641	TX 27	50	2"	6,0		10
05060120001	016218	TX 27	70	2 3/4"	6,0		10
05060190001	030658	TX 27	89	3 1/2"	6,0		10
05060200001	030665	TX 27	152	6"	6,0		10
05060137001	030672	TX 30	50	2"	6,0		10
05060125001	016225	TX 30	70	2 3/4"	6,0		10
05060191001	030689	TX 30	89	3 1/2"	6,0		10
05060201001	030696	TX 30	152	6"	6,0		10
05060138001	030702	TX 40	50	2"	-		10
05060130001	016232	TX 40	70	2 3/4"	-		10
05060192001	030719	TX 40	89	3 1/2"	-		10
05060202001	030726	TX 40	152	6"	-		10

## 867/4 Z TORX® SB bits



Code	EAN						
Code	4013288						
05073720001	132789			<b>867/4 Z TORX®</b>	2x TX 10x50		3
05073526001	105929			<b>867/4 Z TORX®</b>	1x TX 10x89		5
05073470001	226273			<b>867/4 Z TORX®</b>	3x TX 10x89		1
05136311001	213891			<b>867/4 Z TORX®</b>	1x TX 10x152		3
05073721001	132796			<b>867/4 Z TORX®</b>	2x TX 15x50		3
05073527001	105936			<b>867/4 Z TORX®</b>	1x TX 15x89		5
05073471001	226228			<b>867/4 Z TORX®</b>	3x TX 15x89		1
05136312001	213907			<b>867/4 Z TORX®</b>	1x TX 15x152		3
05073722001	132802			<b>867/4 Z TORX®</b>	2x TX 20x50		3
05073528001	105943			<b>867/4 Z TORX®</b>	1x TX 20x89		5
05073472001	226235			<b>867/4 Z TORX®</b>	3x TX 20x89		1
05136313001	213914			<b>867/4 Z TORX®</b>	1x TX 20x152		3
05073723001	132826			<b>867/4 Z TORX®</b>	2x TX 25x50		3
05073529001	105950			<b>867/4 Z TORX®</b>	1x TX 25x89		5
05073473001	226242			<b>867/4 Z TORX®</b>	3x TX 25x89		1
05136314001	213921			<b>867/4 Z TORX®</b>	1x TX 25x152		3
05073724001	132833			<b>867/4 Z TORX®</b>	2x TX 30x50		3
05073530001	105967			<b>867/4 Z TORX®</b>	1x TX 30x89		5
05073474001	226259			<b>867/4 Z TORX®</b>	3x TX 30x89		1
05136315001	213938			<b>867/4 Z TORX®</b>	1x TX 30x152		3
05073531001	105974			<b>867/4 Z TORX®</b>	1x TX 40x89		5
05136316001	213945			<b>867/4 Z TORX®</b>	1x TX 40x152		3

### 867/2 Z TORX® bits

5/16" hexagon, suitable for holders as per DIN ISO 1173-D 8.

#### 867/2 Z TORX® bits



	EAN						
Code	4013288		mm	mm	mm		
05066901001	016096	TX 20	35	1 3/8"	4,5		10
05066900001	016102	TX 25	35	1 3/8"	5,8		10
05066902001	016119	TX 27	35	1 3/8"	5,8		10
05066905001	016126	TX 30	35	1 3/8"	6,0		10
05066910001	016133	TX 40	35	1 3/8"	7,0		10
05066915001	016140	TX 45	35	1 3/8"	-		10
05066920001	016157	TX 50	35	1 3/8"	-		10
05066941001	104007	TX 50	50	2"	-		10
05066950001	104526	TX 50	70	2 3/4"	-		10
05066925001	016164	TX 55	35	1 3/8"	12,0		10

### 867/12 TORX® bits

Thread drive M 5.

#### 867/12 TORX® bits



	EAN						
Code	4013288		mm	mm	mm		
05064155001	026484	TX 20	45	1 3/4"	6,0		10

### 867/15 TORX® bits

Thread drive M 6.

#### 867/15 TORX® bits



	EAN						
Code	4013288		mm	mm	mm		
05064170001	032607	TX 20	45	1 3/4"	8,0		10
05064175001	032980	TX 25	45	1 3/4"	8,0		10

### 867/9 C TORX® bits, halfmoon

Drive: 4 mm halfmoon for direct power tool connection.

#### 867/9 C TORX® bits, halfmoon



	EAN						
Code	4013288		mm	mm	mm		
05135220001	112637	TX 1	44	1 47/64"	1,5		10
05135221001	112644	TX 2	44	1 47/64"	1,5		10
05135222001	112651	TX 3	44	1 47/64"	1,7		10
05345352001	113597	TX 4	44	1 47/64"	1,8		10
05345018001	113504	TX 4	64	2 33/64"	2,0		10
05200496001	214881	TX 5	44	1 47/64"	1,6		10
05345351001	113580	TX 5	44	1 47/64"	3,0		10
05345032001	113542	TX 5	64	2 33/64"	2,0		10
05345350001	113573	TX 6	44	1 47/64"	3,0		10
05345056001	113566	TX 6	64	2 33/64"	2,0		10
05332610001	035868	TX 6	70	2 3/4"	3,0		10
05345035001	113559	TX 7	64	2 33/64"	2,3		10
05345026001	113528	TX 8	44	1 47/64"	3,0		10
05345028001	113535	TX 8	64	2 33/64"	3,0		10
05332609001	035714	TX 8	70	2 3/4"	3,0		10
05332607001	037107	TX 10	70	2 3/4"	3,0		10

### 867/1 Z TORX® BO bits with bore hole

The bore hole in the bit and the pin in the TORX® BO screw prevent any unauthorised loosening – secure fastening.

Tough viscous for universal use. 1/4" hexagon, suitable for holders as per DIN ISO 1173-D 6.3.

#### 867/1 Z TORX® BO bits with bore hole



	EAN						
Code	4013288		mm	mm	mm		
05066497001	015822	TX 7	25	1"			10
05066498001	015839	TX 8	25	1"			10
05066499001	015846	TX 9	25	1"			10
05066500001	015853	TX 10	25	1"			10
05066505001	015860	TX 15	25	1"			10
05066510001	015877	TX 20	25	1"			10
05066515001	015884	TX 25	25	1"			10
05066520001	015891	TX 27	25	1"			10
05066525001	015907	TX 30	25	1"			10
05066530001	015914	TX 40	25	1"			10



### 867/1 Z TORX® BO SB bits with bore hole



Code	EAN			
	4013288			
05073064001	202666		<b>867/1 Z TORX® BO</b> 2x TX 20x25	5
05073065001	202673		<b>867/1 Z TORX® BO</b> 2x TX 25x25	5
05073066001	202680		<b>867/1 Z TORX® BO</b> 2x TX 30x25	5

### 3867/4 TORX® BO bits with bore hole, stainless

Wera stainless steel bits prevent the formation of unsightly extraneous rust. 1/4" hexagon, suitable for holders as per DIN ISO 1173-F 6.3.

### 3867/4 TORX® BO bits with bore hole, stainless



Code	EAN						
	4013288		mm		mm		
05071089001	115546	TX 10	89	3 1/2"	4,0		10
05071090001	115553	TX 15	89	3 1/2"	4,0		10
05071091001	115560	TX 20	89	3 1/2"	4,5		10
05071092001	115577	TX 25	89	3 1/2"	5,5		10
05071094001	115584	TX 30	89	3 1/2"	6,0		10

### 867/4 Z TORX® BO bits with bore hole

Tough viscous for universal use. 1/4" hexagon, suitable for holders as per DIN ISO 1173-D F.3.

### 867/4 Z TORX® BO bits with bore hole



Code	EAN						
	4013288		mm		mm		
05060139001	030733	TX 8	70	2 3/4"	3,0		10
05060048001	094513	TX 8	89	3 1/2"	3,0		10
05060049001	094520	TX 9	89	3 1/2"	3,0		10
05060140001	026897	TX 10	70	2 3/4"	4,0		10
05060050001	094537	TX 10	89	3 1/2"	4,0		5
05060141001	030740	TX 15	70	2 3/4"	4,0		10
05060051001	094544	TX 15	89	3 1/2"	4,0		5
05060142001	026903	TX 20	70	2 3/4"	4,5		10
05060052001	094551	TX 20	89	3 1/2"	4,5		5
05060143001	026910	TX 25	70	2 3/4"	6,0		10
05060053001	094568	TX 25	89	3 1/2"	6,0		10
05060144001	026927	TX 27	70	2 3/4"	6,0		10
05060057001	094643	TX 27	89	3 1/2"	6,0		5
05060145001	026934	TX 30	70	2 3/4"	6,0		10
05060054001	094575	TX 30	89	3 1/2"	6,0		5
05060146001	026941	TX 40	70	2 3/4"	-		10
05060056001	094582	TX 40	89	3 1/2"	-		5



### 867/4 Z TORX® BO SB bits with bore hole

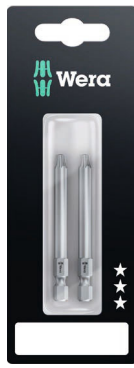

Code	EAN			
	4013288			
05073070001	202604		<b>867/4 Z TORX® BO</b> 2x TX 20x70	5
05073071001	202611		<b>867/4 Z TORX® BO</b> 2x TX 25x70	5
05073072001	202628		<b>867/4 Z TORX® BO</b> 2x TX 30x70	5
05073073001	202574		<b>867/4 Z TORX® BO</b> 2x TX 40x70	5

### 867/1 IP TORX PLUS® bits

High quality bits for recessed TORX PLUS® screws. TORX PLUS® profile: in comparison to normal TORX® profiles, the enlargement of the 6 torque-transferring flanks between the tool and the screw is effected by means of an ellipse-shaped profile design and not a circular one.

This means that the power applied when screwdriving is spread over a larger area. Higher torque is transferred and the service life of the screw and tool is also enhanced. Tough viscous. 1/4" hexagon, suitable for holders as per DIN ISO 1173-D 6.3.

### 867/1 IP TORX PLUS® bits



Code	EAN		⌀	ℓ	ℓ				
	4013288			mm					
05135120001	112606	1 IP	25	1"					10
05135121001	112613	2 IP	25	1"					10
05160956001	113313	3 IP	25	1"					10
05134695001	103109	4 IP	25	1"					10
05066272001	035684	5 IP	25	1"					10
05066274001	031556	6 IP	25	1"					10
05066276001	031563	7 IP	25	1"					10
05066278001	031570	8 IP	25	1"					10
05066279001	033635	9 IP	25	1"					10
05066280001	031549	10 IP	25	1"					10
05066282001	031587	15 IP	25	1"					10
05066284001	031594	20 IP	25	1"					10
05066286001	031600	25 IP	25	1"					10
05066287001	031617	27 IP	25	1"					10
05066288001	031624	30 IP	25	1"					10
05066290001	031631	40 IP	25	1"					10

### 867/4 IP TORX PLUS® bits



Code	EAN		⌀	ℓ	ℓ	∅			
	4013288			mm		mm			
05134664001	112514	1 IP	50	2"		2,0			10
05134665001	112521	2 IP	50	2"		2,0			10
05134668001	106568	3 IP	50	2"		2,0			10
05134691001	103093	4 IP	50	2"		3,0			10
05134678001	098030	5 IP	50	2"		3,0			10
05134680001	037220	6 IP	50	2"		3,0			10
05134667001	095596	6 IP	89	3 1/2"		3,0			10
05134690001	095602	6 IP	152	6"		3,0			10
05134681001	037237	7 IP	50	2"		3,0			10
05134679001	037190	8 IP	50	2"		3,0			10
05134670001	032812	8 IP	89	3 1/2"		3,0			10
05134682001	037244	8 IP	152	6"		3,0			10
05160917001	038951	9 IP	50	2"		3,0			10
05134669001	033871	9 IP	89	3 1/2"		3,0			10
05134683001	037251	10 IP	50	2"		4,0			10
05134684001	037268	10 IP	70	2 3/4"		4,0			10
05134671001	032829	10 IP	89	3 1/2"		4,0			10
05134685001	037275	15 IP	50	2"		4,0			10
05134686001	037282	15 IP	70	2 3/4"		4,0			10
05134672001	032836	15 IP	89	3 1/2"		4,0			10
05134687001	037299	20 IP	50	2"		4,5			10
05134688001	037305	20 IP	70	2 3/4"		4,5			10
05134673001	032843	20 IP	89	3 1/2"		4,5			10
05134609001	224767	25 IP	50	2"		6,0			10
05134674001	032850	25 IP	89	3 1/2"		6,0			10
05134675001	032867	27 IP	89	3 1/2"		6,0			10
05320430001	113382	30 IP	50	2"		6,0			10
05134676001	032874	30 IP	89	3 1/2"		6,0			10
05134677001	032881	40 IP	89	3 1/2"		-			10

### 867/9 C IP TORX PLUS® bits, halfmoon

Drive: 4 mm halfmoon for direct power tool connection.

### 867/9 C IP TORX PLUS® bits, halfmoon



Code	EAN		⌀	ℓ	ℓ	∅	ℓ	ℓ	
	4013288			mm		mm	mm		
05135230001	112668	1 IP	44	1 47/64"		1,5	20	25/32"	10
05135231001	112675	2 IP	44	1 47/64"		1,5	20	25/32"	10
05135232001	112682	3 IP	44	1 47/64"		1,7	20	25/32"	10
05326310001	113399	4 IP	44	1 47/64"		2,0	20	25/32"	10
05345019001	113511	4 IP	64	2 33/64"		2,0	20	25/32"	10
05135233001	112699	5 IP	44	1 47/64"		2,0	20	25/32"	10
05344900001	113498	6 IP	44	1 47/64"		2,25	20	25/32"	10
05135234001	112705	8 IP	44	1 47/64"		3,0	20	25/32"	10
05332606001	037091	8 IP	70	2 3/4"		3,0	20	25/32"	10
05135235001	112712	10 IP	44	1 47/64"		3,0	20	25/32"	10



## IPR TORX PLUS®

A 5-flank TORX PLUS® profile with a borehole.

This drive geometry has only five flanks instead of the usual six and a borehole to protect safety screws against unauthorised unfastening. The screws cannot be turned with conventional, widely available tools.

### 867/1 IPR TORX PLUS® bits with bore hole



	EAN					
Code	4013288		mm			
05134699001	034878	8 IPR	25	1"		10
05134698001	037817	9 IPR	25	1"		10
05134700001	034823	10 IPR	25	1"		10
05134701001	034724	15 IPR	25	1"		10
05134702001	034731	20 IPR	25	1"		10
05134703001	034748	25 IPR	25	1"		10
05134704001	034847	27 IPR	25	1"		10
05134705001	034830	30 IPR	25	1"		10
05134706001	034854	40 IPR	35	1 3/8"		10
05134707001	034861	45 IPR	35	1 3/8"		10

### 867/4 IPR TORX PLUS® bits with bore hole

High quality bits for recessed TORX PLUS® screws. A 5-flank TORX PLUS® profile. 1/4" hexagon, suitable for holders as per DIN ISO 1173-F 6.3.

### 867/4 IPR TORX PLUS® bits with bore hole



	EAN						
Code	4013288		mm		mm		
05160821001	160867	10 IPR	50	2"	4,0		10
05134657001	155665	10 IPR	89	3 1/2"	4,0		10
05134654001	155641	15 IPR	50	2"	4,0		10
05134720001	037206	15 IPR	89	3 1/2"	4,0		10
05204126001	160874	20 IPR	50	2"	4,5		10
05259135001	160881	20 IPR	89	3 1/2"	4,5		10
05134655001	155658	25 IPR	50	2"	6,0		10
05134722001	160904	25 IPR	89	3 1/2"	6,0		10
05134656001	156952	27 IPR	50	2"	6,0		10
05134658001	155672	27 IPR	89	3 1/2"	6,0		10
05134732001	160911	30 IPR	50	2"	6,0		10
05134723001	160935	30 IPR	89	3 1/2"	6,0		10

## BiTorsion system - for longer service life

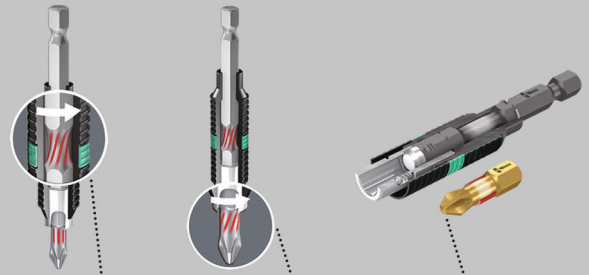

Smaller impacts are absorbed by the holder

Higher impacts are cushioned in the torsion zone of the bit

No premature wear caused by impacts

### 800/1 BDC bits

Bits with tiny diamond particles on the bit tip. This ensures a secure fit of the bit in the screw, reduces the contact pressure required and lowers the risk of slipping.

Comes with Torsion zone – where kinetic energy is diverted from peak loads. This greatly extends the product service life; 1/4" hexagon, suitable for holders as per DIN ISO 1173-D 6.3.

### 800/1 BDC bits



	EAN						
Code	4013288	mm	mm	mm			
05056172001	033949	0,8	5,5	25	1"		10
05056174001	033956	1,0	5,5	25	1"		10
05056176001	033963	1,2	6,5	25	1"		10

### 800/1 BTZ bits

Comes with Torsion zone – where kinetic energy is diverted from peak loads.

This greatly extends the product service life. Tough viscous, for universal use; 1/4" inch hexagon, suitable for holders as per DIN ISO 1173-D 6.3.

#### 800/1 BTZ bits



Code	EAN	mm	mm	mm	mm	mm	mm	mm
05056064001	034427	0,8	5,5	25	1"			10
05056066001	034434	1,0	5,5	25	1"			10
05056068001	034441	1,2	6,5	25	1"			10

### 800/1 TZ bits

Bits with Torsion zone to combat premature wear.

Tough viscous for universal use; 1/4" hexagon, suitable for holders as per DIN ISO 1173-D 6.3.

#### 800/1 TZ bits



Code	EAN	mm	mm	mm	mm	mm	mm	mm
05056203001	011145	0,5	4,0	25	1"	4,0		10
05056210001	011152	0,6	4,5	25	1"	4,5		10
05056220001	011169	0,8	5,5	25	1"	5,5		10
05056225001	011176	1,0	5,5	25	1"	5,5		10
05056233001	011183	1,2	6,5	25	1"	6,2		10
05056240001	011190	1,6	8,0	25	1"	8,0		10

### 800/1 Z bits

Tough viscous Wera bits for universal use. 1/4" hexagon, suitable for holders as per DIN ISO 1173-D 6.3.

#### 800/1 Z bits



Code	EAN	mm	mm	mm	mm	mm	mm	mm
05056200001	040831	0,5	3,0	25	1"	3,0		10
05072050001	030467	0,5	4,0	25	1"	4,0		10
05072055001	010933	0,6	4,5	25	1"	4,5		10
05072057001	010940	0,8	5,5	25	1"	5,5		10
05072059001	010957	1,0	5,5	25	1"	5,5		10
05072061001	010964	1,2	6,5	25	1"	6,2		10
05072063001	030450	1,2	8,0	25	1"	8,0		10
05072065001	010971	1,6	8,0	25	1"	8,0		10

### Kraftform Stainless - stainless steel to prevent rust

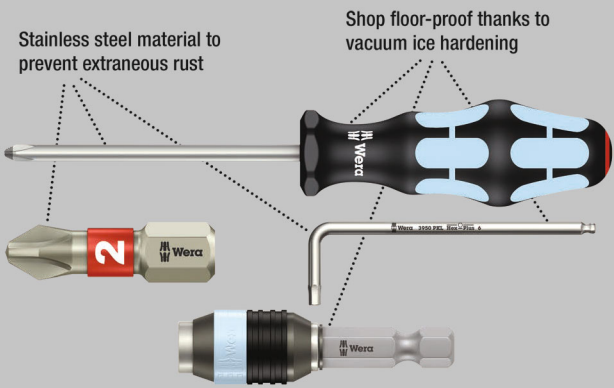

High quality stainless steel bits for slotted screws. Made out of stainless steel which prevents the formation of unsightly extraneous rust. 1/4" hexagon, suitable for holders as per DIN ISO 1173-F 6.3.



### 3800/4 bits, stainless



Code	EAN	mm	mm	mm	mm	mm	mm	mm
05071080001	115669	1,0	5,5	89	3 1/2"			10

## 800/4 Z bits

Tough viscous Wera bits for universal use. 1/4" hexagon, suitable for holders as per DIN ISO 1173-F 6.3.

### 800/4 Z bits



	EAN						
Code	4013288	mm	mm	mm	mm	mm	
05059305001	011480	0,5	3,0	50	2"	3,0	10
05059466001	011497	0,5	3,0	70	2 3/4"	3,0	10
05059307001	011503	0,5	4,0	50	2"	4,0	10
05059310001	011510	0,6	3,5	50	2"	3,5	10
05059472001	011527	0,6	3,5	70	2 3/4"	3,5	10
05059450001	031471	0,6	3,5	152	6"	3,5	10
05059315001	011534	0,6	4,5	50	2"	4,5	10
05059489001	094230	0,6	4,5	89	3 1/2"	4,5	10
05059320001	011541	0,8	4,0	50	2"	4,0	10
05059478001	011558	0,8	4,0	70	2 3/4"	4,0	10
05059480001	011565	0,8	4,0	89	3 1/2"	4,0	10
05059451001	031389	0,8	4,0	152	6"	4,0	10
05059325001	011572	0,8	5,5	50	2"	5,5	10
05059330001	011589	1,0	5,5	50	2"	5,5	10
05059486001	011596	1,0	5,5	70	2 3/4"	5,5	10
05059488001	011602	1,0	5,5	89	3 1/2"	5,5	10
05059452001	031235	1,0	5,5	152	6"	5,5	10
05059335001	035004	1,0	6,0	50	2"	6,0	10
05059337001	011619	1,2	6,5	50	2"	6,2	10
05059492001	011626	1,2	6,5	70	2 3/4"	6,2	10
05059490001	094247	1,2	6,5	89	3 1/2"	6,2	10
05059453001	031488	1,2	6,5	152	6"	6,2	10
05059340001	011633	1,2	8,0	50	2"	8,0	10
05059496001	011640	1,2	8,0	89	3 1/2"	8,0	10
05059345001	011657	1,6	8,0	50	2"	8,0	10
05059500001	011664	1,6	8,0	89	3 1/2"	8,0	10

## 800/2 Z bits

5/16" hexagon, suitable for holders as per DIN ISO 1173-D 8.

### 800/2 Z bits



	EAN						
Code	4013288	mm	mm	mm	mm	mm	
05057225001	011275	1,2	8,0	41	1 19/32"	7,8	10
05057235001	011299	1,6	10,0	41	1 19/32"	7,8	10
05057240001	011305	2,0	12,0	41	1 19/32"	12,0	10

## 800/9 C bits

Hard bits against premature breakage.  
Drive: halfmoon, 4 mm.

### 800/9 C bits



	EAN						
Code	4013288	mm	mm	mm	mm	mm	
05135265001	168276	0,23	1,5	44	1 47/64"	1,5	10
05135264001	194770	0,35	2,5	44	1 47/64"	2,5	10
05135266001	168283	0,40	2,0	44	1 47/64"	2,0	10
05135267001	168290	0,50	3,0	44	1 47/64"	3,0	10

## Impaktor system - For an above-average service life

Impaktor system - for extreme demands

Impaktor holder technology

Particularly high strength  
Superior service life  
Diamond coating

TriTorsion

Impaktor stainless steel holder

High quality Impaktor bits for hexagon socket screws. The Impaktor technology offers an above-average service life even under extreme circumstances.

Enhanced friction resistance, thanks to the rough diamond-particle coating on the bit tip, prevents any slipping out of the screw head. Hex-Plus ensures a greater contact surface in the head of the screw.

The notching effect is therefore reduced to a minimum and damage to the screw head more or less eliminated. 1/4" hexagon, suitable for holders as per DIN ISO 1173-D 6.3.

### 840/1 IMP DC Hex-Plus DIY Impaktor bits

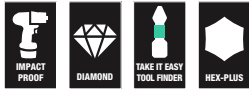

Code	EAN			
	4013288			
05057603001	178701		840/1 IMP DC 10x 3.0x25	1
05057604001	157560		840/1 IMP DC 10x 4.0x25	1
05057605001	157423		840/1 IMP DC 10x 5.0x25	1
05057606001	157430		840/4 IMP DC 10x 6.0x25	1

### 840/1 IMP DC SB Impaktor bits

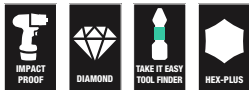

Code	EAN			
	4013288			
05073904001	158338		840/1 IMP DC 1x 4.0x25	5
05073905001	158345		840/1 IMP DC 1x 5.0x25	5
05073906001	158352		840/1 IMP DC 1x 6.0x25	5

### Kraftform Stainless - stainless steel to prevent rust

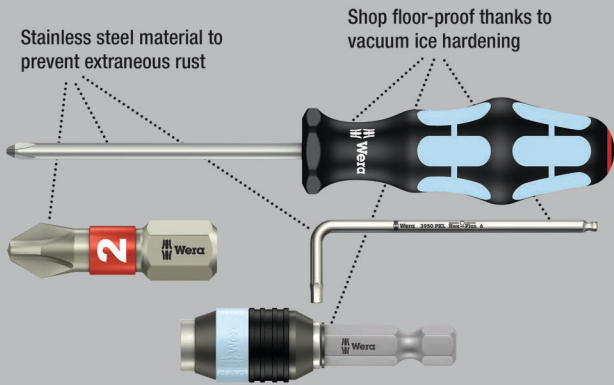

High quality bits out of stainless steel for hexagon socket screws. Prevents the formation of unsightly extraneous rust.

The Hex-Plus profile offers a greater contact surface in the head of the screw. The notching effect is therefore reduced to a minimum and damage to the screw head more or less eliminated.

Come with Torsion zone: Torsion bits take-up torque peaks and absorb them in the Torsion zone. This prevents premature wear and extends the service life of the bit. 1/4" hexagon, suitable for holders as per DIN ISO 1173-D 6.3.

### 3840/1 TS bits, stainless



Code	EAN							
	4013288	mm		mm				
05071070001	111197	1,5		25	1"			10
05071071001	111203	2,0		25	1"			10
05071072001	111210	2,5		25	1"			10
05071073001	111227	3,0		25	1"			10
05071074001	111234	4,0		25	1"			10
05071075001	111241	5,0		25	1"			10
05071077001	115478	5,5		25	1"			10
05071076001	111258	6,0		25	1"			10



## BiTorsion system - for longer service life

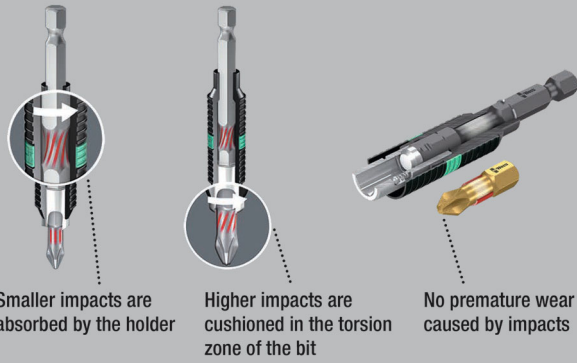

BiTorsion with Torsion zone – where kinetic energy is diverted from peak loads. This greatly extends the product service life.

Tough viscous; 1/4" hexagon, suitable for holders as per DIN ISO 1173-D 6.3.

### 840/1 BTZ bits



Code	EAN	mm	mm	mm			
05056680001	182418	1,5	25	1"			10
05056681001	182425	2,0	25	1"			10
05056682001	182432	2,5	25	1"			10
05056683001	182449	3,0	25	1"			10
05056684001	182456	4,0	25	1"			10
05056685001	182463	5,0	25	1"			10
05056686001	182470	5,5	25	1"			10
05056687001	182487	6,0	25	1"			10

## Hex-Plus - lets hexagon socket screws last longer

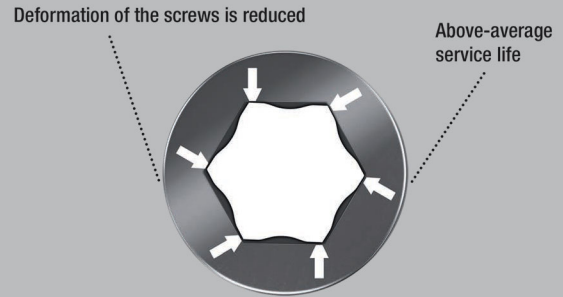

Tough viscous Wera bits for universal use. Hex-Plus offers a greater contact surface in the head of the screw.

The notching effect is therefore reduced to a minimum and damage to the screw head more or less eliminated. 1/4" hexagon, suitable for holders as per DIN ISO 1173-D 6.3.

### 840/1 Z bits



Code	EAN	mm	mm	mm	mm		
05056303001	012623	1,5	25	1"			10
05056305001	012630	2,0	25	1"			10
05056310001	012647	2,5	25	1"			10
05056315001	012654	3,0	25	1"			10
05056320001	012661	4,0	25	1"			10
05056325001	012678	5,0	25	1"			10
05056330001	012685	6,0	25	1"			10
05056332001	038173	7,0	25	1"			10
05056335001	012692	8,0	25	1"			10
05056340001	012708	10,0	25	1"			10
05135060001	106636		0,05"	25	1"		10
05135070001	040862		1/16"	25	1"		10
05135071001	040879		5/64"	25	1"		10
05135072001	037725		3/32"	25	1"		10
05135078001	036599		7/64"	25	1"		10
05135073001	038067		1/8"	25	1"		10
05135069001	040855		9/64"	25	1"		10
05135074001	036506		5/32"	25	1"		10
05135075001	037930		3/16"	25	1"		10
05135079001	040893		7/32"	25	1"		10
05135076001	040886		1/4"	25	1"		10
05135077001	036360		5/16"	25	1"		10
05135068001	040848		3/8"	25	1"		10

## 840/1 Z Sets SB



Code	EAN			
	4013288			
05073050001	202567	⊙	840/1 Z Hex-Plus 2x 2.0x25	5
05073051001	202550	⊙	840/1 Z Hex-Plus 2x 2.5x25	5
05073052001	202512	⊙	840/1 Z Hex-Plus 2x 3.0x25	5
05073053001	202529	⊙	840/1 Z Hex-Plus 2x 4.0x25	5
05073054001	202536	⊙	840/1 Z Hex-Plus 2x 5.0x25	5
05073055001	202543	⊙	840/1 Z Hex-Plus 2x 6.0x25	5
05073342001	029607	⊙	840/1 Z Hex-Plus 1x 2.0x25; 1x 2.5x25; 1x 3.0x25	5
05073344001	029614	⊙	840/1 Z Hex-Plus 1x 4.0x25; 1x 5.0x25; 1x 6.0x25	5

### 842/1 Z bits

The ballpoint drive profile means that it is possible to swivel the tool axis away from the screwdriving axis, thus enabling „round the corner“ screwdriving.

1/4" hexagon, suitable for holders as per DIN ISO 1173-D 6.3.

### 842/1 Z bits



Code	EAN	⊙	⊙	⊙				
	4013288	mm	mm					
05056350001	013156	2,5	25	1"				10
05056352001	013163	3,0	25	1"				10
05056354001	013170	4,0	25	1"				10
05056356001	013187	5,0	25	1"				10
05056358001	013194	6,0	25	1"				10

## Impaktor system - For an above-average service life

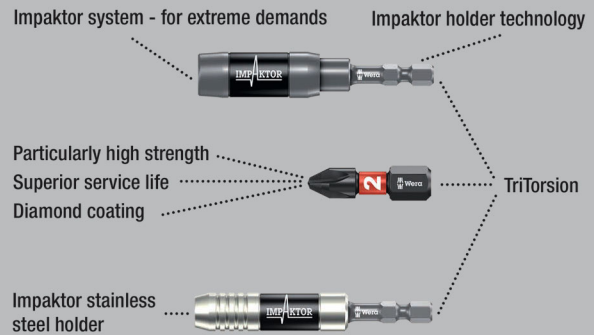

High quality Impaktor bits for hexagonal socket screws. The Impaktor technology offers an above-average service life even under extreme circumstances.

Enhanced friction resistance, thanks to the rough diamond-particle coating on the bit tip, prevents any slipping out of the screw head.

Hex-Plus ensures a greater contact surface in the head of the screw. The notching effect is therefore reduced to a minimum and damage to the screw head more or less eliminated. 1/4" hexagon, suitable for holders as per DIN ISO 1173-F 6.3.

### 840/4 IMP DC Hex-Plus DIY Impaktor bits



Code	EAN			
	4013288			
05057644001	157577	⊙	840/4 IMP DC 5x 4.0x50	1
05057645001	157492	⊙	840/4 IMP DC 5x 5.0x50	1
05057646001	157508	⊙	840/4 IMP DC 5x 6.0x50	1



## 840/4 IMP DC Impaktor bits SB



Code	EAN			
	4013288			
05073944001	158451	○	840/4 IMP DC 1x 4.0x50	5
05073945001	158468	○	840/4 IMP DC 1x 5.0x50	5
05073946001	158475	○	840/4 IMP DC 1x 6.0x50	5

## Kraffform Stainless - stainless steel to prevent rust

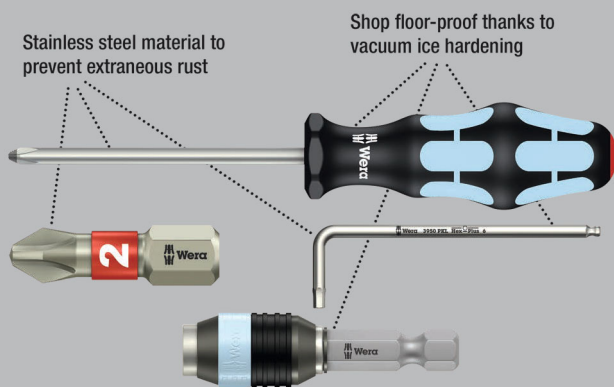

Wera stainless steel bits prevent the formation of unsightly extraneous rust. The Hex-Plus profile offers a greater contact surface in the head of the screw.

The notching effect is therefore reduced to a minimum and damage to the screw head more or less eliminated. 1/4" hexagon, suitable for holders as per DIN ISO 1173-F 6.3.

## 3840/4 Bits, stainless



	EAN	○	○	┌	┌			
Code	4013288	mm		mm				
05071101001	115621	3,0		89	3 1/2"			10
05071102001	115638	4,0		89	3 1/2"			10
05071103001	115645	5,0		89	3 1/2"			10
05071104001	115652	6,0		89	3 1/2"			10
05071105001	115676		3/32"	89	3 1/2"			10
05071106001	115683		1/8"	89	3 1/2"			10
05071107001	115690		5/32"	89	3 1/2"			10
05071108001	115706		3/16"	89	3 1/2"			10

## Hex-Plus - lets hexagon socket screws last longer

Deformation of the screws is reduced

Above-average service life

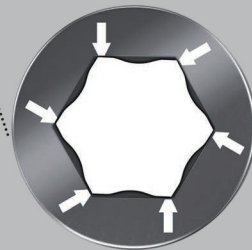

## 840/4 Z Take it easy bits

- Take it easy tool finder: colour coding according to profile and size



## 840/4 Z bits



	EAN	Ø	Ø	l	l	∅		
Code	4013288	mm		mm		mm		
05160885001	200976	0,9		50	2"	2,6		10
05059602001	112408	1,5		50	2"	2,0		10
05059603001	034694	2,0		50	2"	4,0		10
05059628001	155450	2,0		89	3 1/2"	4,0		5
05059604001	034700	2,5		50	2"	4,0		10
05059629001	155467	2,5		89	3 1/2"	4,0		5
05059605001	012906	3,0		50	2"	4,0		10
05059630001	094254	3,0		89	3 1/2"	4,0		5
05380033001	156433	3,0		152	6"	4,0		5
05059610001	012913	4,0		50	2"	5,0		10
05059631001	094261	4,0		89	3 1/2"	5,0		5
05059634001	122964	4,0		152	6"	5,0		5
05059615001	012920	5,0		50	2"	6,0		10
05059632001	094278	5,0		89	3 1/2"	6,0		5
05059635001	122971	5,0		152	6"	6,0		5
05059620001	012937	6,0		50	2"	5,0		10
05059633001	094285	6,0		89	3 1/2"	-		5
05059636001	122988	6,0		152	6"	-		5
05059625001	012944	8,0		50	2"	-		10
05059637001	215031	8,0		89	3 1/2"	-		5
05350430001	161406		0,05"	50	2"	2,5		10
05135090001	107053		1/16"	50	2"	2,5		10
05380045001	156730		1/8"	152	6"	4,0		5
05135091001	036414		5/64"	50	2"	3,0		10
05059660001	155474		5/64"	89	3 1/2"	3,0		5
05135092001	036421		3/32"	50	2"	3,0		10
05059661001	155481		3/32"	89	3 1/2"	3,5		5
05135093001	036438		7/64"	50	2"	3,5		10
05059662001	155498		7/64"	89	3 1/2"	4,0		5
05135094001	036445		1/8"	50	2"	4,0		10
05059663001	155504		1/8"	89	3 1/2"	4,0		5
05135095001	036377		9/64"	50	2"	4,5		10
05059664001	155511		9/64"	89	3 1/2"	4,5		5
05380046001	156822		9/64"	152	6"	4,5		5
05135096001	036384		5/32"	50	2"	5,0		10
05059665001	155528		5/32"	89	3 1/2"	5,0		5
05380047001	156839		5/32"	152	6"	5,0		5
05135097001	036391		3/16"	50	2"	6,0		10
05059666001	155535		3/16"	89	3 1/2"	6,0		5
05380048001	156846		3/16"	152	6"	6,0		5
05135098001	036407		7/32"	50	2"	-		10
05059667001	155542		7/32"	89	3 1/2"	-		5
05380049001	156853		7/32"	152	6"	-		5
05135099001	095589		1/4"	50	2"	-		10
05059668001	155559		1/4"	89	3 1/2"	-		5
05380050001	156860		1/4"	152	6"	-		5
05346288001	103895		5/16"	50	2"	-		10

## 840/4 Z SB bits



Code	EAN			
05073056001	202468	⊙	840/4 Z Hex-Plus 2x 2.0x50	3
05073057001	202475	⊙	840/4 Z Hex-Plus 2x 2.5x50	3
05073058001	202482	⊙	840/4 Z Hex-Plus 2x 3.0x50	3
05136301001	213792	⊙	840/4 Z Hex-Plus 1x 3.0x152	3
05073059001	202499	⊙	840/4 Z Hex-Plus 2x 4.0x50	3
05136302001	213808	⊙	840/4 Z Hex-Plus 1x 4.0x152	3
05073060001	202505	⊙	840/4 Z Hex-Plus 2x 5.0x50	3
05136303001	213815	⊙	840/4 Z Hex-Plus 1x 5.0x152	3
05073061001	202444	⊙	840/4 Z Hex-Plus 2x 6.0x50	3
05136304001	213822	⊙	840/4 Z Hex-Plus 1x 6.0x152	3



### 842/4 Bits

The ballpoint drive profile means that it is possible to swivel the tool axis away from the screwdriving axis, thus enabling „round the corner“ screwdriving. 1/4" hexagon, suitable for holders as per DIN ISO 1173-F 6.3.

### 842/4 Bits



Code	EAN	⊙	⊙	⌄	⌄			
05059680001	155931	3,0		89	3 1/2"			5
05059681001	155948	4,0		89	3 1/2"			5
05059682001	155955	5,0		89	3 1/2"			5
05059683001	155962	6,0		89	3 1/2"			5
05380124001	156587		3/32"	89	3 1/2"			5
05380125001	156594		7/64"	89	3 1/2"			5
05380126001	156600		1/8"	89	3 1/2"			5
05380127001	156617		9/64"	89	3 1/2"			5
05380128001	156624		5/32"	89	3 1/2"			5
05380129001	156631		3/16"	89	3 1/2"			5
05380130001	156648		7/32"	89	3 1/2"			5
05380131001	156655		1/4"	89	3 1/2"			5

### 840/2 Z Bits

Tough viscous Wera bits for hexagon socket screws for universal use. Hex-Plus offers a greater contact surface in the head of the screw. The notching effect is therefore reduced to a minimum and damage to the screw head more or less eliminated. 5/16" hexagon, suitable for holders as per DIN ISO 1173-D 8.

### 840/2 Z Bits



Code	EAN	⊙	⊙	⌄	⌄			
05057505001	012753	3		30	1 3/16"			10
05057510001	012760	4		30	1 3/16"			10
05057515001	012777	5		30	1 3/16"			10
05057520001	012784	6		30	1 3/16"			10
05057525001	012791	8		30	1 3/16"			10
05057530001	012807	10		30	1 3/16"			10

### 840/9 C Bits

Drive: 4 mm halfmoon for direct power tool connection.

### 840/9 C Bits



Code	EAN	⊙	⌄	⌄	∅			
05135268001	168306	1,5	44		1 47/64"	2,6		10
05135269001	168313	2,0	44		1 47/64"	2,6		10

### 840/1 Z Tamper-proof Hex-Plus BO bits

Hexagon socket BO screws have a protruding pin in their drive profile.

This prevents any unauthorised loosening since the "normal" hex tools cannot move these screws. 1/4" hexagon, suitable for holders as per DIN ISO 1173-D 6.3.

### 840/1 Z Tamper-proof Hex-Plus BO bits



Code	EAN	⊙	⌄	⌄				
05056341001	038548	2,0	25	1"				10
05056342001	038555	2,5	25	1"				10
05056343001	038562	3,0	25	1"				10
05056344001	038593	4,0	25	1"				10
05056345001	038579	5,0	25	1"				10
05056346001	038586	6,0	25	1"				10

### 840/4 Z Tamper-proof Hex-Plus B0 bits

1/4" hexagon, suitable for holders as per DIN ISO 1173-F 6.3.

#### 840/4 Z Tamper-proof Hex-Plus B0 bits



	EAN						
Code	4013288	mm	mm		mm		
05059640001	094292	2,0	89	3 1/2"	4,0		5
05059641001	094308	2,5	89	3 1/2"	4,0		5
05059642001	094315	3,0	89	3 1/2"	4,0		5
05059643001	094322	4,0	89	3 1/2"	5,0		5
05059644001	094339	5,0	89	3 1/2"	6,0		5
05059645001	094346	6,0	89	3 1/2"	-		5

### 9506 SB 4-in-1 Bit 1

Four different screw profiles (hexagonal socket screws sizes 3.0; 4.0; 5.0; 6.0) can be operated with only one bit. Significant weight savings of over 50 %.

The operability of the large profiles is made possible by the spring compression of the small tips.

The bit has a 1/4" hexagon drive (Wera connection series 1) and can therefore also be used with e.g. bit ratchets and bitholding screwdrivers with Rapidaptor.

- Innovative, extremely compact quadruple bit – only one bit for four different screw sizes
- Suitable for hexagonal socket screws sizes 3.0; 4.0; 5.0 and 6.0
- Tough for hard materials
- 1/4" hexagon drive (Wera connecting series 1)

#### 9506 SB 4-in-1 Bit 1

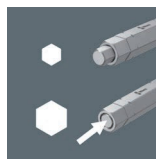

	EAN			
Code	4013288			
05073201001	225269			1
			9506 1x 3,0; 4,0; 5,0; 6,0x37	

### 9507 SB 4-in-1 Bit 2

Four different screw profiles (hexagonal socket screws sizes 2.5; 5.0; 6.0 and TORX® screws size TX 25) can be operated with just one bit.

The enormous space savings make the bit perfect for mobile use. Significant weight savings of over 50 %. The operability of the large profiles is made possible by the spring compression of the small tips.

The bit with a 1/4" hexagon drive (Wera connection series 1) can also be used with e.g. bit ratchets and bitholding screwdrivers with Rapidaptor.

- Innovative, extremely compact quadruple bit – only one bit for four different screw sizes
- Suitable for hexagonal socket screws sizes 2.5; 5.0; 6.0 and TORX® screws TX 25
- Tough for hard materials
- 1/4" hexagon drive (Wera connecting series 1)

#### 9507 SB 4-in-1 Bit 2

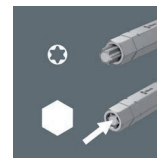

	EAN			
Code	4013288			
05073202001	225276			1
			9507 1x 2,5; 5,0; 6,0; TX 25x37	



## Impaktor system - For an above-average service life

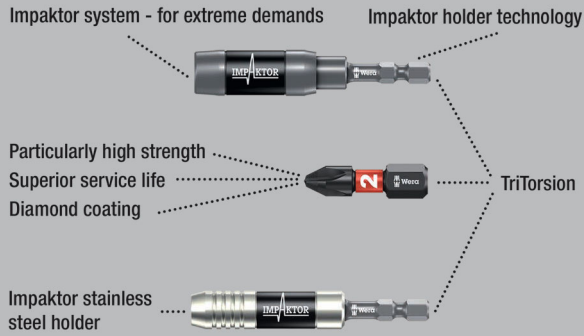

High quality bits for square socket screws. The Impaktor technology offers an above-average service life even under extreme circumstances.

Enhanced friction resistance, thanks to the rough diamond-particle coating on the bit tip, prevents any slipping out of the screw head. Particularly suitable for use with customary impact drivers. 1/4" hexagon, suitable for holders as per DIN ISO 1173-D 6.3.

### 868/1 IMP DC DIY Impaktor square head socket bits



Code	EAN		
05057631001	157478	868/1 IMP DC 10x # 2x25	1
05057632001	157485	868/1 IMP DC 10x # 3x25	1

### 868/1 IMP DC SB Impaktor Square-Plus bits



Code	EAN		
05073931001	158437	868/1 IMP DC 1x # 2x25	5
05073932001	158444	868/1 IMP DC 1x # 3x25	5

### 868/1 V Square-Plus bits

High quality bits for square socket screws with wedging function.

The wedging forces resulting from the contact pressure between the drive tip and the screw profile securely hold the screw on the tool. 1/4" hexagon, suitable for holders as per DIN ISO 1173-D 6.3.

### 868/1 V Square-Plus bits

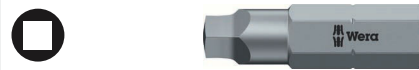

Code	EAN		mm	1"	mm		
05340245001	118202	# 1	25	1"	6,1		10
05066394001	113603	# 2	25	1"	6,1		10
05066396001	169228	# 3	25	1"	6,1		10

### Bit-Box 20 V Robertson



Code	EAN		
05057790001	188083	868/1 V 20x # 2x25	20

### 868/1 Z Square-Plus bits

High quality bits for square socket screws. Tough viscous for universal use. 1/4" hexagon, suitable for holders as per DIN ISO 1173-D 6.3.

#### 868/1 Z Square-Plus bits



Code	EAN	□	□	□	□	□	□
	4013288		mm		mm		
05066395001	030214	# 00	25	1"	3,5		10
05066400001	030221	# 0	25	1"	3,5		10
05066405001	030207	# 1	25	1"	4,5		10
05066410001	030238	# 2	25	1"	6,0		10
05066415001	030245	# 3	25	1"	6,0		10
05066420001	030252	# 4	25	1"	8,0		10

#### 868/1 Z SB Square-Plus bits



Code	EAN	□			
	4013288				
05073074001	202727	□	868/1 Z	2x # 1x25	5
05073075001	202710	□	868/1 Z	2x # 2x25	5

### Impaktor system - For an above-average service life

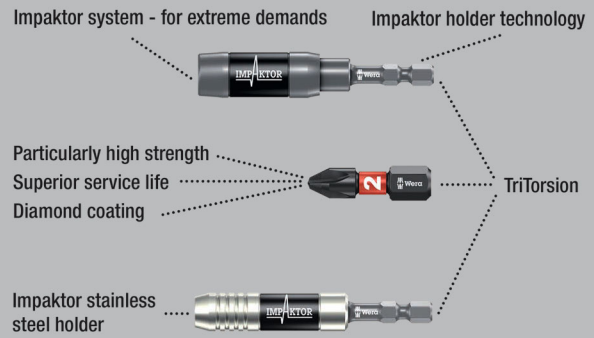

High quality bits for square socket screws. The Impaktor technology offers an above-average service life even under extreme circumstances.

Enhanced friction resistance, thanks to the rough diamond-particle coating on the bit tip, prevents any slipping out of the screw head. Particularly suitable for use with customary impact drivers. 1/4" hexagon, suitable for holders as per DIN ISO 1173-F 6.3.

#### 868/4 IMP DC DIY Impaktor square head socket bits



Code	EAN	□		
	4013288			
05057671001	157546	□	868/4 IMP DC	5x # 2x50
05057672001	157553	□	868/4 IMP DC	5x # 3x50



### 868/4 IMP DC SB Impaktor square head socket bits



Code	EAN		
05073971001	158550		868/4 IMP DC 1x # 2x50
05073972001	158567		868/4 IMP DC 1x # 3x50

### Kraftform Stainless - stainless steel to prevent rust

Stainless steel material to prevent extraneous rust

Shop floor-proof thanks to vacuum ice hardening

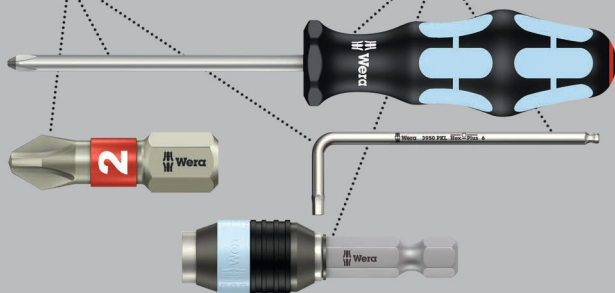

High quality bits out of stainless steel for square socket screws prevent the formation of unsightly extraneous rust. 1/4" hexagon, suitable for holders as per DIN ISO 1173-F 6.3.

### 3868/4 Square-Plus bits, stainless



Code	EAN					
05071097001	115591	# 1	89	3 1/2"	4,5	10
05071098001	115607	# 2	89	3 1/2"	5,0	10
05071099001	115614	# 3	89	3 1/2"	5,5	10

### 868/4 BTZ Square-Plus bits



Code	EAN					
05060147001	041272	#1	50	2"	4,2	10
05060148001	041289	#2	50	2"	4,2	10
05060149001	041296	#3	50	2"	5,5	10

### 868/4 Square-Plus bits



Code	EAN					
05060150001	030269	# 00	50	2"	3,5	10
05060155001	030276	# 0	50	2"	3,5	10
05060160001	030283	# 1	50	2"	4,5	10
05060180001	041043	# 1	70	2 3/4"	4,5	10
05134800001	040930	# 1	89	3 1/2"	4,5	10
05134805001	040923	# 1	152	6"	4,5	10
05060165001	030290	# 2	50	2"	6,0	10
05060182001	041050	# 2	70	2 3/4"	6,0	10
05134801001	040947	# 2	89	3 1/2"	6,0	10
05134806001	040954	# 2	152	6"	6,0	10
05060170001	030306	# 3	50	2"	6,0	10
05060184001	032805	# 3	70	2 3/4"	6,0	10
05134802001	040961	# 3	89	3 1/2"	6,0	10
05134807001	040978	# 3	152	6"	6,0	10
05060175001	030313	# 4	50	2"	8,0	10

### 868/4 Z SB Square-Plus bits



Code	EAN		
05073076001	202703		868/4 Square-Plus 2x # 1x50
05073077001	202697		868/4 Square-Plus 2x # 2x50

## 868/4 V Square-Plus bits

With wedging function.

### 868/4 V Square-Plus bits



	EAN						
Code	4013288		mm		mm		
05060300001	169211	# 1	50	2"	4,5		10
05060297001	169198	# 1	89	3 1/2"	4,5		10
05060301001	113610	# 2	50	2"	6,0		10
05060302001	113627	# 2	70	2 3/4"	6,0		10
05060303001	113634	# 2	89	3 1/2"	6,0		10
05060304001	113641	# 2	152	6"	6,0		10
05060296001	169181	# 3	50	2"	6,0		10
05060298001	169204	# 3	89	3 1/2"	6,0		10

## Diamond-coated bits

Minute diamond particles on the tip of the tool literally bite into the screw

Bits fit securely into the head of the screw

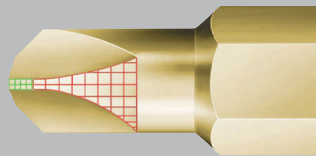

High quality bits with Mplus advantage for more breaking torque and thereby enhanced durability; diamond coating for a secure fit in the screw head.

### 871/1 DC TORQ-SET® Mplus bits



	EAN							
Code	4013288			mm		mm		
05066638001	099525	4		25	1"	4,7		10
05066640001	033161	6		25	1"	4,7		10
05066642001	033178	8		25	1"	6,0		10
05066644001	033185	10		25	1"	6,0		10
05066646001	033192	--	1/4"	32	1 1/4"	11,0		10

## 871/1 TORQ-SET® Mplus bits

TORQ-SET® Mplus: The stronger flanks – when compared with the conventional TORQ-SET® profile – result in 70% more breaking torque and thereby enhanced durability whilst at the same time providing a perfect fit in the screw head.

Tough viscous for universal use. 1/4" hexagon, suitable for holders as per DIN ISO 1173-D 6.3.

### 871/1 TORQ-SET® Mplus bits, 25 mm



	EAN							
Code	4013288			mm		mm		
05066618001	093073	0		25	1"	4,7		10
05066619001	041562	1		25	1"	4,7		10
05066620001	033086	2		25	1"	4,7		10
05066622001	033093	3		25	1"	4,7		10
05066624001	033109	4		25	1"	4,7		10
05066626001	033116	5		25	1"	4,7		10
05066628001	033123	6		25	1"	4,7		10
05066630001	033130	8		25	1"	6,0		10
05066632001	033147	10		25	1"	6,0		10
05066633001	037558	--	1/4"	25	1"	6,0		10

### 871/1 TORQ-SET® Mplus bits, 32 mm



	EAN							
Code	4013288			mm		mm		
05066634001	033154	1/4"		32	1 1/4"	11,0		10
05066635001	093011	5/16"		32	1 1/4"	11,0		10

## 871/4 DC TORQ-SET® Mplus bits

High quality bits with Mplus advantage for more breaking torque and thereby enhanced durability; diamond coating for a secure fit in the screw head.

1/4" hexagon, suitable for holders as per DIN ISO 1173-F 6.3.

### 871/4 DC TORQ-SET® Mplus bits



	EAN							
Code	4013288			mm				
05324901001	162984	2		50	2"			10
05066688001	099532	4		50	2"			10
05066690001	033345	6		50	2"			10
05066692001	033352	8		50	2"			10
05066694001	033369	10		50	2"			10
05066696001	033376	--	1/4"	50	2"			10



### 871/4 TORQ-SET® Mplus bits



	EAN						
Code	4013288			mm			
05066660001	033239	2		50	2"		10
05066683001	094469	2		89	3 1/2"		5
05066662001	033246	3		50	2"		10
05066684001	094476	3		89	3 1/2"		5
05066664001	033253	4		50	2"		10
05066685001	094483	4		89	3 1/2"		5
05066666001	033260	5		50	2"		10
05066668001	033277	6		50	2"		10
05066676001	033307	6		70	2 3/4"		5
05066686001	094490	6		89	3 1/2"		10
05066670001	033055	8		50	2"		10
05066678001	033314	8		70	2 3/4"		5
05066687001	094506	8		89	3 1/2"		10
05066672001	033284	10		50	2"		10
05066680001	033321	10		70	2 3/4"		5
05066682001	033338	10		89	3 1/2"		5
05066674001	033291	--	1/4"	50	2"		10
05221110001	035851	--	5/16"	50	2"		10

### 871/2 TORQ-SET® Mplus bits

5/16" hexagon, suitable for holders as per DIN ISO 1173-D 8.

### 871/2 TORQ-SET® Mplus bits



	EAN					
Code	4013288		mm			
05066654001	033208	1/4"	32	1 1/4"		5
05066656001	033215	5/16"	32	1 1/4"		5

### 875/1 TRI-WING® bits, 25 mm

High quality bits for TRI-WING® screws. Tough viscous for universal use. 1/4" hexagon, suitable for holders as per DIN ISO 1173-D 6.3.

### 875/1 TRI-WING® bits, 25 mm



	EAN						
Code	4013288		mm		mm		
05066758001	093059	0	25	1"	4,7		10
05066760001	033482	1	25	1"	4,7		10
05066762001	033499	2	25	1"	4,7		10
05066764001	033505	3	25	1"	4,7		10
05066766001	033512	4	25	1"	6,2		10
05066768001	033529	5	25	1"	6,2		10

### 875/4 TRI-WING® bits

Tough viscous for universal use. 1/4" hexagon, suitable for holders as per DIN ISO 1173-F 6.3.



	EAN					
Code	4013288		mm			
05066785001	094605	1	89	3 1/2"		5
05066786001	094612	2	89	3 1/2"		5
05066787001	094629	3	89	3 1/2"		5
05066788001	094636	4	89	3 1/2"		5

### 860/1 XZN Multi-point bits

High quality bits for recessed multi-point screws. Tough viscous for universal use. 1/4" hexagon, suitable for holders as per DIN ISO 1173-D 6.3.

### 860/1 XZN Multi-point bits



	EAN						
Code	4013288		mm		mm		
05066150001	034953	M 4	25	1"	4,17		10
05066155001	034960	M 5	25	1"	5,14		10
05066160001	034977	M 6	25	1"	-		10
05066165001	034984	M 8	25	1"	8,0		5
05066170001	034991	M 10	25	1"	10,0		5

### 872/9 bits for Microstix® screws

With 4 mm halfmoon drive for direct insertion in the power tool.

### 872/9 bits for Microstix® screws



	EAN						
Code	4013288		mm	mm			
05066850001	179272	m	44	2,0	1 47/64"		10
05066851001	179296	00	44	2,0	1 47/64"		10
05066852001	179302	F	44	2,0	1 47/64"		10
05066853001	179319	0	44	2,0	1 47/64"		10
05066854001	179326	1	44	2,0	1 47/64"		10



### 857/1 Z Spanner bits

Bits for spanner screws. Tough viscous for universal use. 1/4" hexagon, suitable for holders as per DIN ISO 1173-D 6.3.

#### 857/1 Z Spanner bits



	EAN						
Code	4013288		mm		mm		
05057150001	038609	4	25	1"	3,18		10
05057151001	038616	6	25	1"	4,32		10
05057152001	038623	8	25	1"	5,21		10
05057153001	038630	10	25	1"	6,10		10

### 857/4 Z Spanner bits

Tough viscous for universal use. 1/4" hexagon, suitable for holders as per DIN ISO 1173-F 6.3.

#### 857/4 Z Spanner bits



	EAN						
Code	4013288		mm		mm		
05057160001	094810	4	89	3 1/2"	3,18		5
05057161001	094827	6	89	3 1/2"	4,32		5
05057162001	094834	8	89	3 1/2"	5,21		5
05057163001	094841	10	89	3 1/2"	6,10		5

### Kraftform Stainless - stainless steel to prevent rust

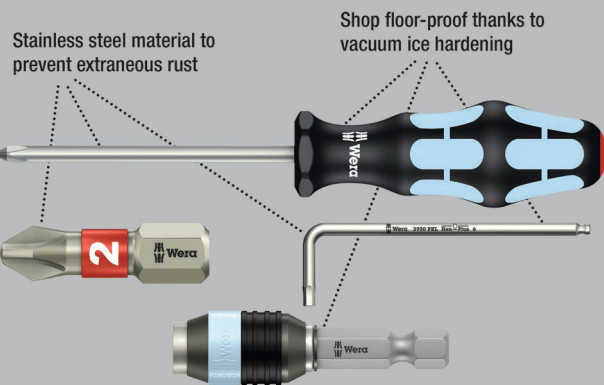

High quality nutsetter out of stainless steel for hexagon head screws. Stainless to prevent the risk of extraneous rust. Non-magnetic design with retaining spring. 1/4" hexagon, suitable for holders as per, DIN ISO 1173-F 6.3.

### 3869/4 Nutsetters, stainless



	EAN						
Code	4013288	mm		mm	mm		
05071222001	118127	7,0		50,0	12,5		5
05071223001	118257	8,0		50,0	14,0		5
05071224001	118141	10,0		50,0	16,0		5
05071225001	118158	13,0		50,0	19,5		5
05071228001	118189		3/8"	50,0	16,0		5

### 869/4 Nutsetters

Non-magnetic design. 1/4" hexagon, suitable for holders as per DIN ISO 1173-F 6.3.

#### 869/4 Nutsetters

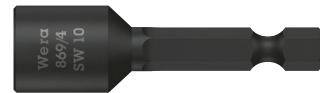

	EAN						
Code	4013288	mm		mm	mm		
05060400001	100948	5,5		50,0	11,0		5
05060272001	016546	5,5		65,0	9,0		5
05060401001	100955	6,0		50,0	11,0		5
05060274001	016553	6,0		65,0	11,0		5
05060402001	100962	7,0		50,0	11,0		5
05060276001	016560	7,0		65,0	11,0		5
05060403001	100979	8,0		50,0	12,5		5
05060278001	016577	8,0		65,0	12,5		5
05060404001	100986	9,0		50,0	14,0		5
05060280001	016584	9,0		65,0	14,0		5
05060405001	100993	10,0		50,0	14,0		5
05060282001	016591	10,0		65,0	14,0		5
05060406001	101006	11,0		50,0	16,0		5
05060281001	031327	11,0		65,0	16,0		5
05060407001	101013	12,0		50,0	18,0		5
05060283001	031334	12,0		65,0	18,0		5
05060408001	101020	13,0		50,0	18,0		5
05060284001	016607	13,0		65,0	19,0		5
05060409001	101037		1/4"	50,0	11,0		5
05060286001	016614		1/4"	65,0	11,0		5
05060410001	101044		5/16"	50,0	12,5		5
05060290001	016638		5/16"	65,0	12,5		5
05060411001	101051		3/8"	50,0	14,0		5
05060288001	016621		3/8"	65,0	14,0		5
05060412001	101068		7/16"	50,0	16,0		5



## 869/4 M Nutsetters, magnetic



	EAN						
Code	4013288	mm		mm	mm		
05060420001	101075	5,5		50,0	11,0		5
05060210001	016652	5,5		65,0	11,0		5
05060421001	101082	6,0		50,0	11,0		5
05060215001	016669	6,0		65,0	11,0		5
05060422001	101099	7,0		50,0	11,0		5
05060220001	016676	7,0		65,0	11,0		5
05060423001	101105	8,0		50,0	12,5		5
05060225001	016683	8,0		65,0	12,5		5
05060424001	101112	9,0		50,0	14,0		5
05060230001	016690	9,0		65,0	14,0		5
05060425001	101129	10,0		50,0	14,0		5
05060235001	016706	10,0		65,0	14,0		5
05060426001	101136	11,0		50,0	16,0		5
05060237001	031501	11,0		65,0	16,0		5
05060427001	101143	12,0		50,0	18,0		5
05060238001	031495	12,0		65,0	17,0		5
05060428001	101150	13,0		50,0	18,0		5
05060240001	016713	13,0		65,0	19,0		5
05060429001	101167		1/4"	50,0	11,0		5
05060255001	016720		1/4"	65,0	11,0		5
05060430001	101174		5/16"	50,0	12,5		5
05060260001	016737		5/16"	65,0	12,5		5
05060431001	101181		3/8"	50,0	14,0		5
05060265001	016744		3/8"	65,0	14,0		5
05060432001	101198		7/16"	50,0	16,0		5

## 869/4 M SB Nutsetters, magnetic



Code	EAN			
	4013288			
05073500001	105691		<b>869/4 M</b> 1x 5.5x50.0	3
05073501001	105707		<b>869/4 M</b> 1x 6.0x50.0	3
05073502001	106506		<b>869/4 M</b> 1x 7.0x50.0	3
05073503001	105714		<b>869/4 M</b> 1x 8.0x50.0	3
05073504001	105721		<b>869/4 M</b> 1x 9.0x50.0	3
05073505001	105738		<b>869/4 M</b> 1x 10.0x50.0	3
05073506001	105745		<b>869/4 M</b> 1x 11.0x50.0	3
05073507001	105752		<b>869/4 M</b> 1x 12.0x50.0	3
05073508001	105769		<b>869/4 M</b> 1x 13.0x50.0	3
05073509001	105776		<b>869/4 M</b> 1x 1/4"x50.0	3
05073510001	105783		<b>869/4 M</b> 1x 3/8"x50.0	3

### 869/4 M Set A SB



Code	EAN			
05073495001	144584	●	<b>869/4 M</b> 1x 7.0x50.0; 1x 8.0x50.0; 1x 10.0x50.0; 1x 12.0x50.0; 1x 13.0x50.0; 1x 1/4"x50.0; 1x 5/16"x50.0; 1x 3/8"x50.0	1

### 869/9 Nutsetters

Metric nutsetter for hexagon head screws. Non-magnetic design. With 4 mm halfmoon drive for direct insertion in the power tool.

#### 869/9 Nutsetters



	EAN	⊙	⌈	∅				
<b>Code</b>	4013288	mm	mm	mm				
05135224001	190505	2,5	44,0	5,0				10
05135225001	190499	3,0	44,0	5,0				10

### 879/4 Internal thread insertion tool

Insertion tool with internal thread for hanger bolts and threaded rods. 1/4" hexagon, suitable for holders as per DIN ISO 1173-F 6.3.

#### 879/4 Internal thread insertion tool



	EAN	⊙	⌈	⌈	∅			
<b>Code</b>	4013288		mm		mm			
05135903001	035059	M8	50,0	2"	12,0			5
05135904001	035066	M10	50,0	2"	12,0			5





# HOLDERS and ADAPTORS



## Impaktor system - For an above-average service life

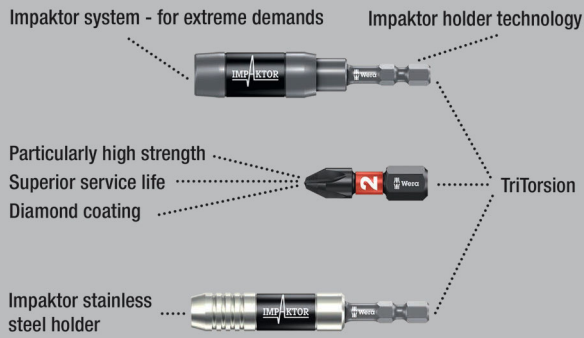

Wera Impaktor holder for the absorption of impulse peaks. Particular torsion effect thanks to the double-torsion spring.

The retaining ring ensures an optimum fit of the tool in the holder. The magnet provides for additional fixing of the bit and screw.

The Impaktor stainless holder with retaining ring and magnet meets the extremely dynamic demands by doing without any small, mechanical parts that are often susceptible.

Used mostly for industrial assembly applications such as e.g. with screwdriving robots. Output: suitable for bits with 1/4" hexagon head drive as per DIN ISO 1173-C 6.3. Drive: 1/4" hexagon, suitable for power screwdrivers with take-up as per DIN ISO 1173-F 6.3.

### 897/4 IMP Impaktor holder with retaining ring and magnet



Code	EAN					
05057675001	157805	1/4"	75	3"	1/4"	5

### 897/4 IMP R Impaktor holder with retaining ring and ring magnet

The Impaktor holder additionally holds long and heavy screws extremely securely with its ring magnet. This enables rapid and dependable positioning of the screw.

Should, situation-related, the magnet not be desired e.g. when working with metal, it can be removed from the screwdriving zone and thereby be neutralised.

Used mostly for manual power tool applications. Output: suitable for bits with 1/4" hexagon head drive as per DIN ISO 1173-C 6.3. Drive: 1/4" hexagon, suitable for power screwdrivers with take-up as per DIN ISO 1173-F 6.3.

### 897/4 IMP R Impaktor holder with retaining ring and ring magnet



Code	EAN					
05057676001	157812	1/4"	75	3"	1/4"	5

### 897/4 IMP R SB Impaktor holder with retaining ring and ring magnet



Code	EAN			897/4 Impaktor R	
05073990001	157836			1x 1/4"x75	3

## Radidaptor - the amazing compact multifunction tool

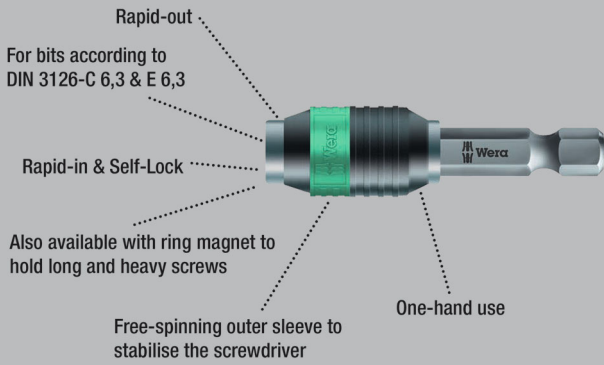

Universal holder for the take-up of bits with 1/4" hexagon head drive as per DIN ISO 1173-C 6.3 (ISO 1173). Stainless design to prevent extraneous rust.

Comes with Rapidaptor technology, which allows bits to be attached without any need to actuate the sleeve. The removal of the bit is simple, just by pushing the sleeve forward – for rapid bit change with just one hand. 1/4" hexagon, suitable for power screwdrivers with take-up as per DIN ISO 1173-F 6.3.

### 3888/4/1 K Radidaptor Universal Bit Holder, stainless



	EAN							
Code	4013288		mm		mm			
05071100001	111487	1/4"	50	2"	1/4"	15,0		5

### 3888/4/1 K SB Radidaptor Universal Bit Holder, stainless



Code	EAN						
05073616001	112170			3888/4/1 K	1x 1/4"x50		3

## BiTorsion system - for longer service life

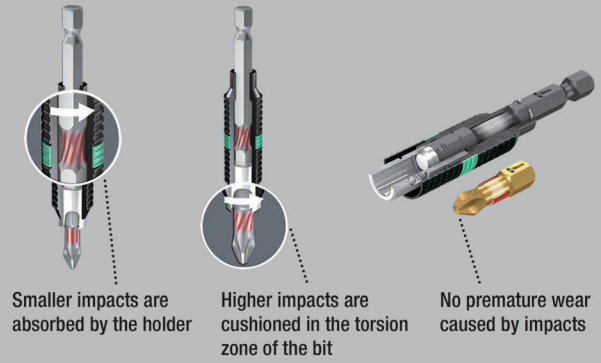

Universal holder for bits with 1/4" hexagon head drive as per DIN ISO 1173-C 6.3 and E 6.3 (ISO 1173). BiTorsion holders by Wera have a torsion spring that absorbs low peak loads during screwdriving jobs.

The combined use with BiTorsion bits and their torsion zones extends the service life of the tool considerably. BiTorsion holders by Wera can, however, also be used with conventional bits. The Rapidaptor technology allows bits to be attached without any need to actuate the sleeve.

The removal of the bit is simple, just by pushing the sleeve forward. This enables rapid bit change with just one hand. 1/4" hexagonal, suitable for power screwdrivers with take-up as per DIN ISO 1173-F 6.3.

### 897/4 R Radidaptor BiTorsion Universal Bit Holder



	EAN						
Code	4013288		mm		mm		
05053923001	095633	1/4"	75	3"	1/4"	15,0	5

### 897/4 R SB Radidaptor BiTorsion Universal Bit Holder



Code	EAN					
05073420001	099464			897/4 R	1x 1/4"x75	3

### 889/4/1 K Rapidaptor Universal Bit Holder

Rapidaptor universal holder for bits with 1/4" hexagon head drive as per DIN ISO 1173-C 6.3 and E 6.3 (ISO 1173). The Rapidaptor allows bits to be attached without any need to actuate the sleeve.

The removal of the bit is simple, just by pushing the sleeve forward. This enables rapid bit change with just one hand. The strong permanent magnet holds the bits absolutely securely. 1/4" hexagonal, suitable for power screwdrivers with take-up as per DIN ISO 1173-F 6.3.

### 889/4/1 K Rapidaptor Universal Bit Holder



	EAN							
Code	4013288		mm			mm		
05052502001	095626	1/4"	50	2"	1/4"	15,0		5

### 889/4/1 K SB Rapidaptor Universal Bit Holder



	EAN							
Code	4013288							
05073421001	099440			889/4/1 K	1x 1/4"x50			3

### 889/4/1 Rapidaptor Universal Bit Holder



	EAN							
Code	4013288		mm			mm		
05052503001	098016	1/4"	75	3"	1/4"	15,0		5

### 889/4 R Rapidaptor Universal Bit Holder



	EAN							
Code	4013288		mm			mm		
05052504001	101242	1/4"	100	4"	1/4"	15,0		2

### 888/4/1 K Rapidaptor Universal Bit holder

- Non-magnetic design

### 888/4/1 K Rapidaptor Universal Bit Holder



	EAN							
Code	4013288		mm			mm		
05052500001	095619	1/4"	50	2"	1/4"	15,0		5

### 887/4 RR Rapidaptor Universal Bit Holder with ring magnet

Rapidaptor universal holder for bits with hexagon head drive as per DIN ISO 1173-C 6.3 and E 6.3 (ISO 1173). The floating, free-turning magnetic sleeve securely holds even large and heavy screws. The Rapidaptor allows bits to be attached without any need to actuate the sleeve.

The removal of the bit is simple, just by pushing the sleeve forward. This enables rapid bit change with just one hand. 1/4" hexagonal, suitable for power screwdrivers with take-up as per DIN ISO 1173-F 6.3.

### 887/4 RR Rapidaptor Universal Bit Holder with ring magnet



	EAN							
Code	4013288		mm			mm		
05052490001	104045	1/4"	57	2 1/4"	1/4"	16		5

### 887/4 RR SB Rapidaptor Universal Bit Holder with ring magnet



	EAN							
Code	4013288							
05073511001	105790			887/4 RR	1x 1/4"x57			3



### 889/4/1 F Rapidaptor free-running bit holder for torque screwdrivers with pistol handle

The free-running feature allows for a particularly quick return movement without having to remove the screwdriver when tightening screws.

Especially for application with Wera torque screwdrivers with pistol handle for fast and ergonomic working.

The Rapidaptor technology allows mounting bits without activating the sleeve. Remove the bits by simply pushing the sleeve forward - for rapid bit change, all with one hand.

- Avoids annoying re-positioning when tightening screws with Wera torque screwdrivers with pistol handle
- Fast and fatigue-free work due to precise free-running mechanism
- Maintenance-free construction with especially slim and solid bearing by leading free-running manufacturer
- Maximum transmissible tightening moment 10,0 Nm
- Bit mounting with Rapidaptor technology for rapid bit change, suitable for bits with 1/4" - external hexagon drive as per DIN ISO 1173-C 6.3 and E 6.3 and Wera connection series 1 and 4

### 889/4/1 F Rapidaptor free-running bit holder for torque screwdrivers with pistol handle



	EAN							
Code	4013288		mm			mm		
05052501001	217585	1/4"	64	2 33/64"	1/4"	16,5		5

### 894/4/1 K Universal Bit Holder

Universal holder for the take-up of bits with 1/4" hexagon head drive as per DIN ISO 1173-C 6.3.

Quick-release chuck for rapid bit change. 1/4" hexagonal, suitable for power screwdrivers with take-up as per DIN ISO 1173-F 6.3.

### 894/4/1 K Universal Bit Holder



	EAN							
Code	4013288		mm			mm		
05053522001	017512	1/4"	51	2"	1/4"	14,3		5

### 894/4/1 Universal Bit Holder



	EAN							
Code	4013288		mm			mm		
05053520001	017505	1/4"	75	3"	1/4"	14,3		5

### 895/4/1 K Universal Bit Holder

Universal holder for the take-up of bits with 1/4" hexagon head drive as per DIN ISO 1173-C 6.3. Quick-release chuck for rapid bit change.

The strong permanent magnet holds the bits absolutely securely. 1/4" hexagonal, suitable for power screwdrivers with take-up as per DIN ISO 1173-F 6.3.

### 895/4/1 K Universal Bit Holder



	EAN							
Code	4013288		mm			mm		
05053872001	035158	1/4"	52	2"	1/4"	14,3		5

### 895/4/1 K SB Universal Bit Holder



	EAN							
Code	4013288							
05073318001	029195				895/4/1 K	1x 1/4"x52		3

### 895/4/1 Universal Bit Holder



	EAN							
Code	4013288		mm			mm		
05053870001	017574	1/4"	77	3"	1/4"	14,3		5

### 898/4 Combination Bit Holder

Combination holder for bits with 4 mm halfmoon drive (Wera series 9) and 4 mm HIOS drive (Wera series 21): quick-release chuck, 1/4" hexagonal drive, suitable for power screwdrivers with a take-up as per DIN ISO 1173-F 6.3.

#### 898/4 Combination Bit Holder



	EAN						
<b>Code</b>	4013288	mm			mm		
05051500001	184177	50	2"	1/4"	10,0		5

### 898/9 Combination Bit Holder

Suitable for bits with 4 mm halfmoon drive (Wera series 9) and 4 mm HIOS drive (Wera series 21): with quick-release chuck, 4 mm halfmoon drive.

#### 898/9 Combination Bit Holder



	EAN						
<b>Code</b>	4013288	mm		mm			
05051501001	184184	50	2"	10,0			5

### 898/21 Combination Bit Holder

Suitable for bits with 4 mm halfmoon drive (Wera series 9) and 4 mm HIOS drive (Wera series 21): with quick-release chuck, 4 mm HIOS drive.

#### 898/21 Combination Bit Holder



	EAN						
<b>Code</b>	4013288	mm		mm			
05051502001	184191	50	2"	10,0			5

### 890/4/1 Universal Bit Holder

Universal holder for the take-up of bits with 1/4" hexagon head drive as per DIN ISO 1173-C 6.3. The retaining ring ensures an optimum fit of the tool in the holder.

1/4" hexagonal, suitable for power screwdrivers with take-up as per DIN ISO 1173-F 6.3.

#### 890/4/1 Universal Bit Holder



	EAN							
<b>Code</b>	4013288		mm			mm		
05052575001	017239	1/4"	57	2 1/4"	1/4"	11,1		5

### 893/4/1 K Universal Bit Holder

Universal holder for the take-up of bits with 1/4" hexagon head drive as per DIN ISO 1173-C 6.3.

Stainless sleeve for special corrosion protection. 1/4" hexagon, suitable for power screwdrivers with a take-up as per DIN ISO 1173-F 6.3.

#### 893/4/1 K Universal Bit Holder



	EAN							
<b>Code</b>	4013288		mm			mm		
05134480001	017468	1/4"	50	2"	1/4"	10,5		5

### 893/4/1 K SB Universal Bit Holder



	Code	EAN				
		4013288				
	05073401001	029133			893/4/1 K 1x 1/4"x50	3

### 899/3/1 Universal Bit Holder

Stainless steel sleeve for very special corrosion protection. The strong permanent magnet holds the bits absolutely securely.

Universal holder for the take-up of bits with 1/4" hexagon head drive as per DIN ISO 1173-C 6.3. 5.5 mm, suitable for power screwdrivers with take-up as per DIN ISO 1173-B 5.5.

#### 899/3/1 Universal Bit Holder



	EAN							
Code	4013288		mm		mm	mm		
05053425001	017659	1/4"	72	2 3/4"	5,5	10,5		5

### 899/4/1 Universal Bit Holder

Stainless steel sleeve for very special corrosion protection. The retaining ring ensures an optimum fit of the tool in the holder. The strong permanent magnet holds the bits absolutely securely.

Universal holder for the take-up of bits with 1/4" hexagon head drive as per DIN ISO 1173-C 6.3. 1/4" hexagonal, suitable for power screwdrivers with take-up as per DIN ISO 1173-F 6.3.

#### 899/4/1 Universal Bit Holder



	EAN								
Code	4013288	Art.No.		mm			mm		
05053457001	017673	899/4/1 K	1/4"	50	2"	1/4"	10,5	5	
05053455001	017666	899/4/1 75	1/4"	75	3"	1/4"	10,5	5	
05053459001	036711	899/4/1 100	1/4"	100	4"	1/4"	10,5	5	
05053458001	036728	899/4/1 152	1/4"	152	6"	1/4"	10,5	5	

#### 899/4/1 SB Universal Bit Holder



Code	EAN							
05347100001	095268			899/4/1	1x 1/4"x50			3
05073357001	029720			899/4/1	1x 1/4"x75			3
05134398001	099907			899/4/1	1x 1/4"x152			3

### 899/4/1 S Universal Bit Holder with strong retaining ring

The particularly strong retaining ring ensures an optimum fixing of the tool in the holder. The especially strong permanent magnet makes sure that the bits are held absolutely securely.

Universal holder for the take-up of bits with 1/4" hexagon head drive as per DIN ISO 1173-C 6.3. 1/4" hexagon, suitable for holders as per DIN ISO 1173-F 6.3.

#### 899/4/1 S Universal Bit Holder with strong retaining ring



	EAN							
Code	4013288		mm			mm		
05160976001	105271	1/4"	50	2"	1/4"	10,5		5
05160924001	105264	1/4"	75	3"	1/4"	10,5		5
05160977001	105288	1/4"	100	4"	1/4"	10,5		5
05160979001	105301	1/4"	200	8"	1/4"	10,5		1
05160981001	105325	1/4"	300	12"	1/4"	10,5		1

### 899/14/1 Universal Bit Holder

Drive: SDS plus.

#### 899/14/1 SB Universal Bit Holder



Code	EAN						
05134397001	099891			899/14/1	1x 1/4"x79		3

### 881/4/1 SB Bit holder with variable screw depth limitation

For patio construction, the screws should be countersunk to be evenly flush with the decking.

The 881/4/1 bit holder with variable screw depth limitation and felt ring allows for a uniform depth and protects the surface from brush marks. Two spare felt rings included.

- Bit holder for evenly flush countersunk screws in patio construction
- With adjustable screw depth limitation
- Felt ring (exchangeable) prevents brush marks on decking
- Included: 2 spare felt rings

### 881/4/1 SB Bit holder with variable screw depth limitation



<b>Code</b>	<b>EAN</b>							
05130002001	219282							1
		●●	881/4/1					
			1x 1/4"x90 <sup>1)</sup>					
			9201					
			2x 27,0					

<sup>1)</sup>The spare part kit with 5x felt rings can be ordered with the code number 05130003001.

### 9200 Spare part kit felt rings for 881/4/1 bit holder

- Five spare felt rings for the 881/4/1 SB bit holder with variable screw depth limitation.
- Felt rings prevent brush marks on decking.

### 9200 Spare part kit felt rings for 881/4/1 bit holder



<b>Code</b>	<b>EAN</b>							
05130003001	219299							1
			9201					
			5x 27,0					

### 896/4/1 SB Bit Holder with adjustable depth-control stop

High quality spacer out of aluminium: the screwdriving depth can be infinitely adjusted and allows the flush-mounting of screws.

### 896/4/1 SB Bit Holder with adjustable depth-control stop



<b>Code</b>	<b>EAN</b>							
05073210001	178725	●●	896/4/1					1
			1x 1/4"x50					

### 870/1 Adaptor

Tool shaft for nutsetters. Output: 1/4" square head; drive: 1/4" hexagon.

### 870/1 Adaptor



	<b>EAN</b>	□	⋄	⋄	○			
<b>Code</b>	4013288		mm					
05136000001 <sup>1)</sup>	016997	1/4"	25	1"	1/4"			5

<sup>1)</sup>With friction ball; for manual nut spinner sockets

### 870/4 Adaptor

Tool shaft for manual nutsetter inserts; with ball. Output: Square head; drive 1/4" hexagon.

### 870/4 Adaptor



	<b>EAN</b>	□	⋄	⋄	○			
<b>Code</b>	4013288		mm					
05311517001 <sup>1)</sup>	098214	1/4"	50	2"	1/4"			10
05138006001 <sup>1)</sup>	233387	1/4"	72	2"	2 53/64"			10

<sup>1)</sup>With friction ball; for manual nut spinner sockets

## 870/4 SB



Code	EAN				
05134399001	099914	□	870/4 A	1x 1/4"x1/4"x50 <sup>1)</sup>	3
05073985001	233271	□	870/4 A	1x 1/4"x1/2"x72 <sup>1)</sup>	3

<sup>1)</sup>With friction ball; for manual nut spinner sockets

### 870/2 Adaptor

Tool shaft for power tool nutsetter inserts with square head drive.  
5/16" hexagon drive.

### 870/2 Adaptor



Code	EAN	□	□	□	□	□	□	□
05136001001 <sup>1)</sup>	184245	3/8"	30	1 3/16"	5/16"			5
05136002001 <sup>1)</sup>	184269	1/2"	35	1 3/8"	5/16"			5

<sup>1)</sup>With friction ball; for manual nut spinner sockets

### 870/4 Adaptor

Tool shaft (adaptor) for power tool sockets with hexagon head drive by Wera.  
Drive: 1/4" hexagon.

### 870/4 Adaptor



Code	EAN	□	□	□	□	□	□	□
05050205001 <sup>1)</sup>	017055	1/4"	50	2"	1/4"			5
05050210001 <sup>1)</sup>	017062	1/4"	100	4"	1/4"			5
05050215001 <sup>1)</sup>	017079	3/8"	50	2"	1/4"			5
05050220001 <sup>1)</sup>	017086	3/8"	100	4"	1/4"			5

<sup>1)</sup>With locking pin; for machine-operated nut spinner sockets

## 870/4/7 Set A SB



Code	EAN				
05073200001	139115	□	870/4	1x 1/4"x50 <sup>1)</sup> ; 1x 3/8"x50 <sup>1)</sup>	1
		□	870/7	1x 1/2"x75 <sup>1)</sup>	

<sup>1)</sup>With locking pin; for machine-operated nut spinner sockets

### 870/14 Adaptor

Tool shaft for power tool sockets with square head drive.  
Drive: SDS plus.

### 870/14 Adaptor



Code	EAN	□	□	□	□	□	□	□
05050650001 <sup>1)</sup>	017208	1/4"	70	2 3/4"				5

<sup>1)</sup>With locking pin; for machine-operated nut spinner sockets

### 870/7 Adaptor

Tool shank for power tool sockets; square head output.  
7/16" hexagonal, suitable for power screwdrivers with take-up as per DIN ISO 1173-F 11.2.

### 870/7 Adaptor



Code	EAN	□	□	□	□	□	□	□
05050510001 <sup>1)</sup>	017178	1/2"	75	3"	7/16"			5

<sup>1)</sup>With locking pin; for machine-operated nut spinner sockets

### 781 A 1/4" Connection parts

Connection part 1/4" square head socket to 3/8" (1/2") external square head. For manual and machine-operated tools (non-impact), with ball stop groove to safely lock the socket, knurling at the rear end for manageability during manual use; chrome-vanadium, brushed chrome-plated finish.

- With 1/4" square head socket drive
- With secure socket fixing
- Made of chrome-vanadium for high load capacity

#### 781 A 1/4" Connection parts



Code	EAN	Art.No.	mm	mm	mm	mm	mm
05042670001	221193	781 A/B	3/8"	25,2	1"	1/4"	1
05042671001	221209	781 A/C	1/2"	36,0	1 27/64"	1/4"	1

### 781 B 3/8" Connection parts

Connection part 3/8" square head socket to 1/4" (1/2") external square head. For manual and machine-operated tools (non-impact), with ball stop groove to safely lock the socket, knurling at the rear end for manageability during manual use; chrome-vanadium, brushed chrome-plated finish.

- With 3/8" square head socket drive
- With secure socket fixing
- Made of chrome-vanadium for high load capacity

#### 781 B 3/8" Connection parts



Code	EAN	Art.No.	mm	mm	mm	mm	mm
05042672001	221247	781 B/A	1/4"	27,0	1 1/16"	3/8"	1
05042673001	221056	781 B/C	1/2"	36,0	1 27/64"	3/8"	1

### 781 C 1/2" Connection parts

Connection part 1/2" square head socket to 3/8" external square head. For manual and machine-operated tools (non-impact), with ball stop groove to safely lock the socket, knurling at the rear end for manageability during manual use; chrome-vanadium, brushed chrome-plated finish.

- With 1/2" square head socket drive
- With secure socket fixing
- Made of chrome-vanadium for high load capacity

#### 781 C 1/2" Connection parts



Code	EAN	Art.No.	mm	mm	mm	mm	mm
05042674001	221216	781 C/B	3/8"	35,5	1 25/64"	1/2"	1

### 781/5 Set 1

Robust textile belt with 5 connection parts: 781 A: 1/4" square head socket drive, for 3/8" and 1/2" square head socket wrench inserts with ball lock; 781 B: 3/8" square head socket drive, for 1/4" and 1/2" square head socket wrench inserts with ball lock; 781 C: 1/2" square head socket drive, for 3/8" square head socket wrench inserts with ball lock.

- Set with 5 connection parts (adapters) for square head socket wrench inserts
- With secure socket fixing
- With square head socket drive
- With external square head drive
- Made of chrome-vanadium for high load capacity

#### 781/5 Set 1



Code	EAN	Art.No.	mm	mm	mm	mm	mm
05042680001	221223						1
		781 A	1x 781 A/B, 3/8"x25,2x1/4"; 1x 781 A/C, 1/2"x36,0x1/4"				
		781 B	1x 781 B/A, 1/4"x27,0x3/8"; 1x 781 B/C, 1/2"x36,0x3/8"				
		781 C	1x 781 C/B, 3/8"x35,5x1/2"				
		Belt 781 0/5	1x 45,0x210,0				

### 784 A 1/4" Adaptor with quick-release chuck

Adaptor from square to hexagonal. Comes with quick-release chuck for rapid bit change.

Suitable for the attachment of bits with 1/4" hexagon drive as per DIN ISO 1173-C 6.3. Drive: 1/4" square.

#### 784 A 1/4" Adaptor with quick-release chuck



	EAN						
Code	4013288	Art.No.		mm			
05042750001	008022	784 A/1	1/4"	30	1 3/16"	1/4"	5

#### 784 B 3/8" Adaptor with quick-release chuck



	EAN						
Code	4013288	Art.No.		mm			
05042755001	008039	784 B/1	1/4"	43	1 5/8"	3/8"	5
05042765001	008046	784 B/2	5/16"	50	2"	3/8"	5

#### 784 C 1/2" Adaptor with quick-release chuck



	EAN						
Code	4013288	Art.No.		mm			
05042760001	008053	784 C/1	1/4"	50	2"	1/2"	5
05042768001	008060	784 C/2	5/16"	50	2"	1/2"	5

### 780 A 1/4" Adaptor

Adaptor from square to hexagonal. Suitable for bits with 1/4" hexagon drive as per DIN ISO 1173-C 6.3.

Drive: 1/4" square.

#### 780 A 1/4" Adaptor



	EAN						
Code	4013288	Art.No.		mm			
05042605001	007940	780 A/1	1/4"	25	1"	1/4"	5

#### 780 B 3/8" Adaptor



	EAN						
Code	4013288	Art.No.		mm			
05042655001	007971	780 B/1	1/4"	30	1 3/16"	3/8"	5
05344511001 <sup>1)</sup>	113450	780 B/1-S	1/4"	30	1 3/16"	3/8"	5
05042665001	007988	780 B/2	5/16"	30	1 3/16"	3/8"	5
05344512001 <sup>1)</sup>	113467	780 B/2-S	5/16"	30	1 3/16"	3/8"	5

<sup>1)</sup>S = extra strong

#### 780 C 1/2" Adaptor



	EAN						
Code	4013288	Art.No.		mm			
05042705001	007995	780 C/1	1/4"	35	1 3/8"	1/2"	5
05344513001	113474	780 C/1-S	1/4"	35	1 3/8"	1/2"	5
05042715001	008008	780 C/2	5/16"	35	1 3/8"	1/2"	5
05344514001 <sup>1)</sup>	113481	780 C/2-S	5/16"	35	1 3/8"	1/2"	5

<sup>1)</sup>S = extra strong





Tool-Check PLUS

Wera

Wera  
Be a Tool Pro.



# Bit Sets



## Impaktor system - For an above-average service life

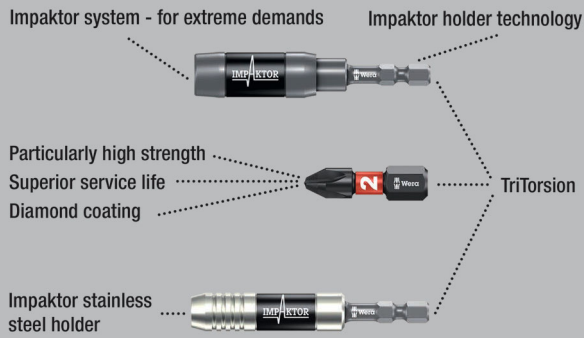

The Impaktor technology offers an above-average service life even under extreme circumstances thanks to the best possible utilisation of the material properties and the optimised geometry; particularly suitable for use with customary impact drivers.

The rough diamond-coating of the bits reduces the risk of a slipping out of the screw head thanks to the enhanced frictional resistance.

The profile and size of the bits are easy to recognise thanks to the Wera Take it easy Tool Finder with its colour coding and clearly visible imprint.

The multi-component Bit-Check is convincing on account of its low weight and the maximum possible degree of compactness. In this respect, the soft material in the lower section of the Bit-Check ensures that the bits are securely held whilst being simple to remove at the same time.

### Bit-Check 30 Impaktor 1



Code	EAN		
05057690001	4013288 156778		1
		<ul style="list-style-type: none"> <li>● 897/4 Impaktor R 1x 1/4"x75</li> <li>⊕ 851/1 IMP DC 2x PH 1x25; 3x PH 2x25; 2x PH 3x25</li> <li>⊕ 855/1 IMP DC 2x PZ 1x25; 3x PZ 2x25; 2x PZ 3x25</li> <li>⊕ 867/1 IMP DC 1x TX 10x25; 1x TX 15x25; 2x TX 20x25; 3x TX 25x25; 2x TX 30x25; 2x TX 40x25</li> <li>○ 840/1 IMP DC 1x 3,0x25; 1x 4,0x25; 1x 5,0x25; 1x 6,0x25</li> </ul>	

### Bit-Check 30 Impaktor 2



Code	EAN		
05057697001	4013288 203946		1
		<ul style="list-style-type: none"> <li>● 897/4 Impaktor 1x 1/4"x75</li> <li>⊕ 851/1 IMP DC 2x PH 1x25; 3x PH 2x25; 2x PH 3x25</li> <li>⊕ 855/1 IMP DC 2x PZ 1x25; 3x PZ 2x25; 2x PZ 3x25</li> <li>⊕ 867/1 IMP DC 1x TX 10x25; 1x TX 15x25; 2x TX 20x25; 3x TX 25x25; 2x TX 30x25; 2x TX 40x25</li> <li>○ 840/1 IMP DC 1x 3,0x25; 1x 4,0x25; 1x 5,0x25; 1x 6,0x25</li> </ul>	

### Bit-Check 10 Impaktor 1



Code	EAN		
05057680001	4013288 156785		10
		<ul style="list-style-type: none"> <li>● 897/4 Impaktor R 1x 1/4"x75</li> <li>⊕ 851/1 IMP DC 1x PH 2x25; 1x PH 3x25</li> <li>⊕ 855/1 IMP DC 1x PZ 2x25; 1x PZ 3x25</li> <li>⊕ 867/1 IMP DC 1x TX 20x25; 1x TX 25x25; 1x TX 30x25</li> <li>○ 840/1 IMP DC 1x 4,0x25; 1x 5,0x25</li> </ul>	

### Bit-Check 10 Impaktor 1 SB



Code	EAN			
05073980001	4013288 158574			1
		●○	897/4 Impaktor R 1x 1/4"x75	
		+	851/1 IMP DC 1x PH 2x251x PH 3x25	
		+	855/1 IMP DC 1x PZ 2x251x PZ 3x25	
		✳	867/1 IMP DC 1x TX 20x251x TX 25x251x TX 30x25	
		○	840/1 IMP DC 1x 4.0x251x 5.0x25	

### Bit-Check 10 Impaktor 2



Code	EAN			
05057682001	4013288 156792			10
		●○	897/4 Impaktor R 1x 1/4"x75	
		+	851/1 IMP DC 3x PH 2x25; 1x PH 3x25	
		✳	867/1 IMP DC 3x TX 25x25; 1x TX 30x25; 1x TX 40x25	

### Bit-Check 10 Impaktor 3



Code	EAN			
05057683001	4013288 156761			10
		●○	897/4 Impaktor R 1x 1/4"x75	
		+	855/1 IMP DC 3x PZ 2x25; 1x PZ 3x25	
		✳	867/1 IMP DC 3x TX 25x25; 1x TX 30x25; 1x TX 40x25	

### Bit-Check 10 Impaktor 4



Code	EAN			
05057417001	4013288 180148			10
		●○	897/4 Impaktor 1x 1/4"x75	
		+	855/1 IMP DC 3x PZ 2x25; 1x PZ 3x25	
		✳	867/1 IMP DC 2x TX 20x25; 2x TX 25x25; 1x TX 30x25	

### Bit-Check 10 PZ Impaktor 1



Code	EAN			
05057684001	4013288 157829			10
		●○	897/4 Impaktor R 1x 1/4"x75	
		+	855/1 IMP DC 7x PZ 2x25; 2x PZ 3x25	

### Bit-Check 10 TX Impaktor 1



Code	EAN			
05057688001	4013288 163394			10
		●○	897/4 Impaktor R 1x 1/4"x75	
		✳	867/1 IMP DC 3x TX 20x25; 3x TX 25x25; 2x TX 30x25; 1x TX 40x25	

### Bit-Check 6 Impaktor 1



Code	EAN		
05057695001	157751		10
		+	851/4 IMP DC 1x PH 2x50; 1x PH 3x50
		+	855/4 IMP DC 1x PZ 2x50; 1x PZ 3x50
		+	867/4 IMP DC 1x TX 25x50; 1x TX 30x50

### Bit-Check 6 Impaktor 1 SB



Code	EAN		
05073890001	158635		1
		+	851/4 IMP DC 1x PH 2x50; 1x PH 3x50
		+	855/4 IMP DC 1x PZ 2x50; 1x PZ 3x50
		+	867/4 IMP DC 1x TX 25x50; 1x TX 30x50

### Bit-Check 6 PH Impaktor 1



Code	EAN		
05057691001	157713		20
		+	851/4 IMP DC 4x PH 2x50; 2x PH 3x50

### Bit-Check 6 PZ Impaktor 1



Code	EAN		
05057692001	157737		20
		+	855/4 IMP DC 4x PZ 2x50; 2x PZ 3x50

### Bit-Check 6 TX Impaktor 1



Code	EAN		
05057693001	157744		20
		+	867/4 IMP DC 2x TX 20x50; 2x TX 25x50; 1x TX 30x50; 1x TX 40x50

### Kraftform Stainless - stainless steel to prevent rust

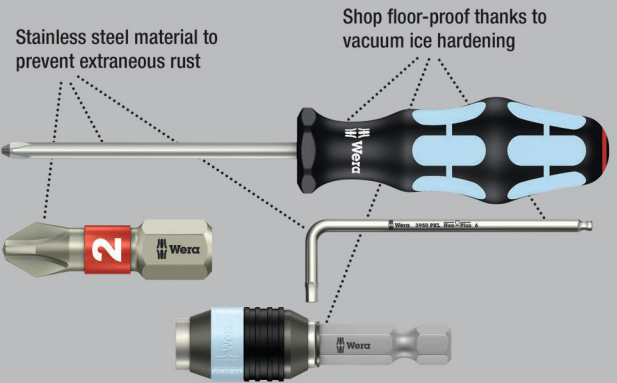

Bit-Check that can be positioned upright with high quality bits out of stainless steel. Wera stainless tools are manufactured out of stainless steel, thus preventing the formation of unsightly extraneous rust. The multi-component Bit-Check is convincing on account of its low weight and the maximum possible degree of compactness.

In this respect, the soft material in the lower section of the Bit-Check ensures that the bits are securely held whilst being simple to remove at the same time. The profile and size of the bits are easy to recognise thanks to the Wera Take it easy Tool Finder with its colour coding and clearly visible imprint.

### Bit-Check 30 Stainless 1



Code	EAN			
05071109001	115126			1
		●	<b>3888/4/1 K</b> 1x 1/4"x50	
		+	<b>3851/1 TS PH</b> 1x PH 1x25; 3x PH 2x25; 1x PH 3x25	
		+	<b>3855/1 TS PZ</b> 2x PZ 1x25; 3x PZ 2x25; 1x PZ 3x25	
		✦	<b>3867/1 TS TORX®</b> 2x TX 10x25; 2x TX 15x25; 3x TX 20x25; 3x TX 25x25; 2x TX 30x25; 1x TX 40x25	
		○	<b>3840/1 TS</b> 1x 2,5x25; 1x 3,0x25; 1x 4,0x25; 1x 5,0x25; 1x 5,5x25 <sup>1)</sup>	

<sup>1)</sup>Without Torsion zone

### Bit-Check 10 Stainless 1



Code	EAN			
05071110001	111494			10
		●	<b>3888/4/1 K</b> 1x 1/4"x50	
		+	<b>3851/1 TS PH</b> 1x PH 2x25	
		+	<b>3855/1 TS PZ</b> 1x PZ 1x25; 2x PZ 2x25	
		✦	<b>3867/1 TS TORX®</b> 1x TX 10x25; 1x TX 15x25; 1x TX 20x25; 1x TX 25x25; 1x TX 30x25	

### Bit-Check 10 Stainless 1 SB



Code	EAN			
05073630001	112163			1
		●	<b>3888/4/1 K</b> 1x 1/4"x50	
		+	<b>3851/1 TS PH</b> 1x PH 2x25	
		+	<b>3855/1 TS PZ</b> 1x PZ 1x25; 2x PZ 2x25	
		✦	<b>3867/1 TS TORX®</b> 1x TX 10x25; 1x TX 15x25; 1x TX 20x25; 1x TX 25x25; 1x TX 30x25	

### Bit-Check 6 Stainless 1 SB

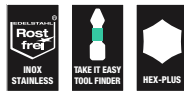

Code	EAN			
05073634001	164636			1
		+	<b>3855/4</b> 2x PZ 2x50	
		✦	<b>3867/4 TORX®</b> 1x TX 20x50; 2x TX 25x50	
		○	<b>3840/4 Hex-Plus</b> 1x 5.5x50	



## BiTorsion system - for longer service life

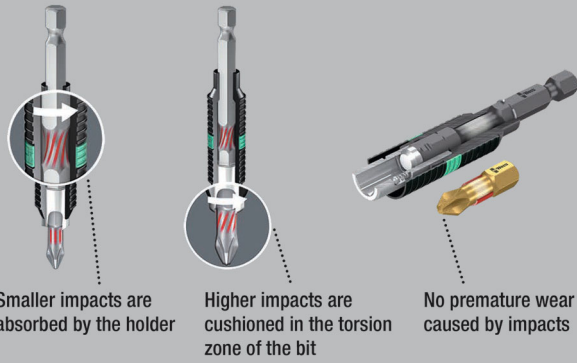

### Bit-Safe 61 BiTorsion 1

Robust textile box with bits and holder, 61-piece. 49 BiTorsion bits for long service life, in diamond-coated design (BDC) for a secure fit in the screw head, tough-absorbing (BTZ), for universal use, extra hard (BTH); 11 bits, tough-absorbing (Z), for universal use. 1 universal holder 889/4/1 K with quick-release chuck for take-up in the power screwdriver or use in the chuck of the power drill.

The profile and size of the bits are easy to recognise thanks to the Wera Take it easy Tool Finder with its colour coding and clearly visible imprint. The textile box allows users a high degree of mobility with a minimum space requirement.

The greatly reduced weight of a set makes carrying far more pleasant. Sensitive surfaces are protected when the box is set down – yet the textile box is still very robust. The box and the tools will even survive a fall unscathed.

### Bit-Safe 61 BiTorsion 1



Code	EAN		
05057441001	4013288 179937		1
		●○ 889/4/1 K 1x 1/4"x50	
		⊕ 851/1 BDC PH 1x PH 1x25; 2x PH 2x25; 1x PH 3x25	
		⊕ 851/1 BTZ PH 2x PH 1x25; 8x PH 2x25; 1x PH 3x25	
		⊕ 855/1 BDC PZ 1x PZ 1x25; 2x PZ 2x25; 1x PZ 3x25	
		⊕ 855/1 BTH PZ 2x PZ 1x25; 8x PZ 2x25; 1x PZ 3x25	
		⊕ 867/1 TORX® BTZ 3x TX 10x25; 2x TX 15x25; 4x TX 20x25; 4x TX 25x25; 2x TX 30x25; 1x TX 40x25	
		● 800/1 BDC 1x 0,8x5,5x25; 1x 1,0x5,5x25; 1x 1,2x6,5x25	
		○ 840/1 BTZ Hex-Plus 3x 2,5x25; 3x 3,0x25; 3x 4,0x25; 2x 5,0x25	
		Hook and Loop Fastener Strip 120 1x 50,0x120,0	

## Bit-Checks BiTorsion

BiTorsion bits with a torsion zone – where kinetic energy is diverted from peak loads. This greatly extends the product service life. Offer the best possible service life with the appropriate holder.

The multi-component Bit-Check is convincing on account of its low weight and the maximum possible degree of compactness.

In this respect, the soft material in the lower section of the Bit-Check ensures that the bits are securely held whilst being simple to remove at the same time.

The profile and size of the bits are easy to recognise thanks to the Wera Take it easy Tool Finder with its colour coding and clearly visible imprint.

### Bit-Check 30 BiTorsion 1



Code	EAN			
05057430001	4013288 179821			1
		●○	<b>889/4/1 K</b> 1x 1/4"x50	
		+	<b>851/1 BTZ PH</b> 2x PH 1x25; 5x PH 2x25; 2x PH 3x25	
		+	<b>855/1 BTZ PZ</b> 2x PZ 1x25; 6x PZ 2x25; 2x PZ 3x25	
		✳	<b>867/1 TORX® BTZ</b> 1x TX 10x25; 2x TX 15x25; 2x TX 20x25; 2x TX 25x25; 2x TX 30x25; 1x TX 40x25	

### Bit-Check 12 BiTorsion 1



Code	EAN			
05057420001	4013288 179869			10
		●○	<b>889/4/1 K</b> 1x 1/4"x50	
		+	<b>851/1 BTZ PH</b> 1x PH 1x25; 2x PH 2x25	
		+	<b>855/1 BTZ PZ</b> 1x PZ 1x25; 2x PZ 2x25	
		✳	<b>867/1 TORX® BTZ</b> 1x TX 10x25; 1x TX 15x25; 1x TX 20x25; 1x TX 25x25; 1x TX 30x25	

### Bit-Check 12 BiTorsion 1 SB



Code	EAN			
05136385001	4013288 213969			1
		●○	<b>889/4/1 K</b> 1x 1/4"x50	
		+	<b>851/1 BTZ PH</b> 1x PH 1x25; 2x PH 2x25	
		+	<b>855/1 BTZ PZ</b> 1x PZ 1x25; 2x PZ 2x25	
		✳	<b>867/1 TORX® BTZ</b> 1x TX 10x25; 1x TX 15x25; 1x TX 20x25; 1x TX 25x25; 1x TX 30x25	



### Bit-Check 10 BiTorsion 1



Code	EAN			
05056374001	4013288 095688			10
		●○	897/4 R 1x 1/4"x75	
		+	851/1 BTZ PH 1x PH 1x25; 1x PH 2x25; 1x PH 3x25	
		+	855/1 BTZ PZ 1x PZ 1x25; 1x PZ 2x25; 1x PZ 3x25	
		—	800/1 BTZ 1x 0,8x5,5x25; 1x 1,0x5,5x25; 1x 1,2x6,5x25	

### Bit-Check 10 BiTorsion 3 SB



Code	EAN			
05073418001	4013288 128157	●○	897/4 R 1x 1/4"x75	1
		+	851/1 BTZ PH 1x PH 2x25	
		+	855/1 BTZ PZ 1x PZ 1x25; 1x PZ 2x25; 1x PZ 3x25	
		+	867/1 TORX® BTZ 1x TX 10x25; 1x TX 15x25; 1x TX 20x25; 1x TX 25x25; 1x TX 30x25	

### Bit-Check 10 PZ BiTorsion 2

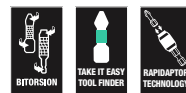

Code	EAN			
05347153001	4013288 107152			10
		●○	897/4 R 1x 1/4"x75	
		+	855/1 BTH PZ 1x PZ 1x25; 7x PZ 2x25; 1x PZ 3x25	

### Diamond-coated bits

Minute diamond particles on the tip of the tool literally bite into the screw

Bits fit securely into the head of the screw

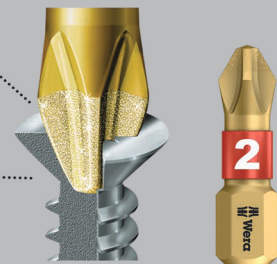

Bits with tiny diamond particles on the bit tip. This ensures a secure fit in the screw head, reduces the contact pressure required and lowers the risk of slipping.

BiTorsion bits with a torsion zone – where kinetic energy is diverted from peak loads. This greatly extends the product service life.

The multi-component Bit-Check is convincing on account of its low weight and the maximum possible degree of compactness. In this respect, the soft material in the lower section of the Bit-Check ensures that the bits are securely held whilst being simple to remove at the same time.

The profile and size of the bits are easy to recognise thanks to the Wera Take it easy Tool Finder with its colour coding and clearly visible imprint.



### Bit-Check 30 Diamond 1



Code	EAN			
	4013288			
05057431001	179814			1
			<b>889/4/1 K</b> 1x 1/4"x50	
			<b>851/1 BDC PH</b> 2x PH 1x25; 4x PH 2x25; 1x PH 3x25	
			<b>855/1 BDC PZ</b> 2x PZ 1x25; 4x PZ 2x25; 1x PZ 3x25	
			<b>867/1 TORX® BDC</b> 2x TX 10x25; 2x TX 15x25; 3x TX 20x25; 3x TX 25x25; 1x TX 30x25; 1x TX 40x25	
			<b>800/1 BDC</b> 1x 0,8x5,5x25; 1x 1,0x5,5x25; 1x 1,2x6,5x25	

### Bit-Check 12 Diamond 1



Code	EAN			
	4013288			
05057421001	180025			10
			<b>889/4/1 K</b> 1x 1/4"x50	
			<b>851/1 BDC PH</b> 1x PH 1x25; 2x PH 2x25	
			<b>855/1 BDC PZ</b> 1x PZ 1x25; 2x PZ 2x25	
			<b>867/1 TORX® BDC</b> 1x TX 10x25; 1x TX 15x25; 1x TX 20x25; 1x TX 25x25; 1x TX 30x25	

### Bit-Check 12 Diamond 1 SB

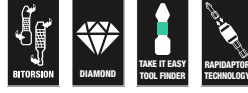

Code	EAN			
	4013288			
05136392001	213976		<b>889/4/1 K</b> 1x 1/4"x50	1
			<b>851/1 BDC PH</b> 1x PH 1x25; 2x PH 2x25	
			<b>855/1 BDC PZ</b> 1x PZ 1x25; 2x PZ 2x25	
			<b>867/1 TORX® BDC</b> 1x TX 10x25; 1x TX 15x25; 1x TX 20x25; 1x TX 25x25; 1x TX 30x25	

### Bit-Check 7 Diamond 1



Code	EAN			
	4013288			
05057416001	179999			10
			<b>889/4/1 K</b> 1x 1/4"x50	
			<b>851/1 BDC PH</b> 1x PH 1x25; 1x PH 2x25	
			<b>855/1 BDC PZ</b> 1x PZ 1x25; 1x PZ 2x25	
			<b>800/1 BDC</b> 1x 1,0x5,5x25; 1x 1,2x6,5x25	



### Bit-Check 7 Diamond 1 SB

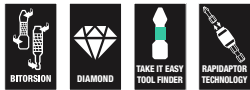

Code	EAN		
05073419001	183682	889/4/1 K 1x 1/4"x50	1
		851/1 BDC PH 1x PH 1x25; 1x PH 2x25	
		855/1 BDC PZ 1x PZ 1x25; 1x PZ 2x25	
		800/1 BDC 1x 1.0x5.5x25; 1x 1.2x6.5x25	

### Bit-Check 7 PZ Diamond 1



Code	EAN		
05057412001	180001	889/4/1 K 1x 1/4"x50	10
		855/1 BDC PZ 2x PZ 1x25; 3x PZ 2x25; 1x PZ 3x25	

### Bit-Check 7 TX Diamond 1



Code	EAN		
05057415001	180018	889/4/1 K 1x 1/4"x50	10
		867/1 TORX® BDC 1x TX 10x25; 1x TX 15x25; 1x TX 20x25; 1x TX 25x25; 1x TX 30x25; 1x TX 40x25	

### Textile boxes



### Bit-Safe 61 Universal 1

Comprehensive 61-piece bit set in a robust Bit-Safe. Provides a quick overview of the tools available and bits not needed are simply reinserted into the set and do not get lost.

1 universal holder with Rapidaptor technology: allows bits to be attached without any need to actuate the sleeve. The removal of the bit is simple, just by pushing the sleeve forward – for rapid bit change with just one hand.

The strong permanent magnet holds the bits absolutely securely. Can be inserted in the power screwdriver or for use in the chuck of the electric drill.

### Bit-Safe 61 Universal 1



Code	EAN			
05057122001	4013288 100689			1
		● ○	<b>889/4/1 K</b> 1x 1/4"x50	
		+	<b>851/1 TZ</b> 3x PH 1x25; 10x PH 2x25; 2x PH 3x25	
		+	<b>855/1 TZ</b> 3x PZ 1x25; 10x PZ 2x25; 2x PZ 3x25	
		✦	<b>867/1 TZ TORX®</b> 2x TX 10x25; 3x TX 15x25; 3x TX 20x25; 3x TX 25x25; 3x TX 30x25; 2x TX 40x25	
		⊖	<b>800/1 TZ</b> 1x 0,6x4,5x25; 1x 1,0x5,5x25; 1x 1,2x6,5x25	
		○	<b>840/1 Z</b> 3x 2,5x25; 3x 3,0x25; 3x 4,0x25; 2x 5,0x25	
			<b>Hook and Loop Fastener Strip 120</b> 1x 50,0x120,0	

### Bit-Safe 43 Universal 1

43-piece; robust textile box with bits for universal applications.

1 universal holder 899/4/1 with stainless sleeve, retaining ring and strong permanent magnet for insertion in the power screwdriver or for use in the chuck of the electric drill.

### Bit-Safe 43 Universal 1



Code	EAN			
05057450001	4013288 179951			1
		● ○	<b>899/4/1</b> 1x 1/4"x50	
		+	<b>851/1 Z</b> 1x PH 2x25	
		+	<b>851/4 TZ</b> 1x PH 1x50; 2x PH 2x50	
		+	<b>855/1 Z</b> 2x PZ 1x25; 5x PZ 2x25; 2x PZ 3x25	
		✦	<b>855/4 TZ</b> 1x PZ 1x50; 2x PZ 2x50	
		✦	<b>867/1 TORX®</b> 3x TX 10x25; 4x TX 15x25; 4x TX 20x25; 4x TX 25x25; 4x TX 30x25; 1x TX 40x25	
		✦	<b>867/4 Z TORX®</b> 1x TX 10x50; 1x TX 15x50; 1x TX 20x50; 1x TX 25x50; 1x TX 30x50; 1x TX 40x50	
			<b>Hook and Loop Fastener Strip 120</b> 1x 50,0x120,0	



## Bit-Check 30 Universal 1

29 bits in a minimum of space; simple removal and reinsertion of the bits. Rapidaptor holder ensures rapid bit change.

Universal bits fitted for diverse applications.

### Bit-Check 30 Universal 1



Code	EAN		
05056440001	115096		1
		<b>889/4/1 K</b> 1x 1/4"x50	
		<b>851/1 TZ PH</b> 2x PH 1x25; 3x PH 2x25; 1x PH 3x25	
		<b>855/1 TH PZ</b> 2x PZ 1x25; 3x PZ 2x25; 1x PZ 3x25	
		<b>867/1 TZ TORX®</b> 1x TX 10x25; 1x TX 15x25; 1x TX 20x25; 1x TX 25x25; 1x TX 30x25; 1x TX 40x25	
		<b>867/1 Z TORX® B0</b> 1x TX 10x25; 1x TX 15x25; 1x TX 20x25; 1x TX 25x25; 1x TX 30x25	
		<b>800/1 TZ</b> 1x 1,0x5,5x25	
		<b>840/1 Z Hex-Plus</b> 1x 3,0x25; 1x 4,0x25; 1x 5,0x25; 1x 6,0x25; 1x 8,0x25	

## Bit-Check 30 TX Universal 1

30-piece. Tough-absorbing bits for universal use. 1 universal holder 899/4/1 K for take-up in the power screwdriver or use in the chuck of the power drill.

Comes with tough viscous TORX® bits for universal use.

### Bit-Check 30 TX Universal 1



Code	EAN		
05057908001	163820		10
		<b>899/4/1</b> 1x 1/4"x50	
		<b>867/1 TORX®</b> 3x TX 10x25; 5x TX 15x25; 8x TX 20x25; 7x TX 25x25; 4x TX 30x25; 2x TX 40x25	

### Bit-Check 30 TX Universal 1 SB



Code	EAN		
05057900001	229618		1
		<b>899/4/1</b> 1x 1/4"x50	
		<b>867/1 TORX®</b> 3x TX 10x25; 5x TX 15x25; 8x TX 20x25; 7x TX 25x25; 4x TX 30x25; 2x TX 40x25	

### Bit-Check 10 Universal 1

- Tough viscous bits for universal use
- Universal holder with quick-release chuck for rapid bit change

#### Bit-Check 10 Universal 1



Code	EAN		
05056161001	4013288 033772		10
		<b>895/4/1 K</b> 1x 1/4"x52	
		<b>851/1 TZ PH</b> 1x PH 1x25; 1x PH 2x25; 1x PH 3x25	
		<b>855/1 TZ PZ</b> 1x PZ 1x25; 1x PZ 2x25; 1x PZ 3x25	
		<b>800/1 TZ</b> 1x 0,8x5,5x25; 1x 1,0x5,5x25; 1x 1,2x6,5x25	

### Bit-Check 10 Universal 2

- Extra-hard bits
- Torsion design against premature wear
- Universal holder with quick-release chuck and strong permanent magnet

#### Bit-Check 10 Universal 2



Code	EAN		
05134200001	4013288 038821		10
		<b>895/4/1 K</b> 1x 1/4"x52	
		<b>855/1 TH PZ</b> 1x PZ 1x25; 2x PZ 2x25	
		<b>867/1 TORX®</b> 1x TX 10x25; 1x TX 15x25; 1x TX 20x25; 1x TX 25x25; 1x TX 30x25; 1x TX 40x25	

### Bit-Check 10 Universal 3

- Tough viscous bits for universal use
- Rapidaptor holder for rapid bit change

#### Bit-Check 10 Universal 3



Code	EAN		
05056375001	4013288 095695		10
		<b>889/4/1 K</b> 1x 1/4"x50	
		<b>851/1 TZ PH</b> 1x PH 1x25; 1x PH 2x25; 1x PH 3x25	
		<b>855/1 TZ PZ</b> 1x PZ 1x25; 1x PZ 2x25; 1x PZ 3x25	
		<b>800/1 TZ</b> 1x 0,8x5,5x25; 1x 1,0x5,5x25; 1x 1,2x6,5x25	

### Bit-Check 10 Universal 3 SB



Code	EAN		
05073410001	4013288 099495		1
		<b>889/4/1 K</b> 1x 1/4"x50	
		<b>800/1 TZ</b> 1x 0,8x5,5x25; 1x 1,0x5,5x25; 1x 1,2x6,5x25	
		<b>851/1 TZ PH</b> 1x PH 1x25; 1x PH 2x25; 1x PH 3x25	
		<b>855/1 TZ PZ</b> 1x PZ 1x25; 1x PZ 2x25; 1x PZ 3x25	



### Bit-Check 10 Universal 4

- Tough viscous bits for universal use
- Universal holder with stainless sleeve, retaining ring and strong permanent magnet

#### Bit-Check 10 Universal 4



Code	EAN		
05056159001	4013288 033758		10
		899/4/1 1x 1/4"x50	
		851/1 TZ PH 1x PH 1x25; 1x PH 2x25; 1x PH 3x25	
		855/1 TZ PZ 1x PZ 1x25; 1x PZ 2x25; 1x PZ 3x25	
		800/1 TZ 1x 0,8x5,5x25; 1x 1,0x5,5x25; 1x 1,2x6,5x25	

### Bit-Check 10 Universal 5 SB

- Tough viscous bits for universal use
- Includes universal holder for the take-up of bits with 1/4" hex head drive

#### Bit-Check 10 Universal 5 SB



Code	EAN		
05073416001	4013288 128164		1
		899/4/1 1x 1/4"x50	
		851/1 Z PH 1x PH 2x25	
		855/1 Z PZ 1x PZ 1x25; 1x PZ 2x25; 1x PZ 3x25	
		867/1 TORX® 1x TX 10x25; 1x TX 15x25; 1x TX 20x25; 1x TX 25x25; 1x TX 30x25	

### Bit-Check 10 TX Universal 1

- Tough viscous bits for universal use
- Torsion design against premature wear
- Universal holder with quick-release chuck for rapid bit change

#### Bit-Check 10 TX Universal 1



Code	EAN		
05056164001	4013288 033802		10
		894/4/1 K 1x 1/4"x51	
		867/1 TZ TORX® 1x TX 8x25; 1x TX 9x25; 1x TX 10x25; 1x TX 15x25; 1x TX 20x25; 1x TX 25x25; 1x TX 27x25; 1x TX 30x25; 1x TX 40x25	

### Bit-Check 10 TX Universal 2

- Tough viscous bits for universal use
- Rapidaptor holder for rapid bit change

#### Bit-Check 10 TX Universal 2



Code	EAN		
05057115001	4013288 127747		10
		888/4/1 K 1x 1/4"x50	
		867/1 TORX® 1x TX 6x25; 1x TX 8x25; 1x TX 9x25; 1x TX 10x25; 1x TX 15x25; 1x TX 20x25; 1x TX 25x25; 1x TX 30x25; 1x TX 40x25	

### Bit-Check 7 Universal 1

- Tough viscous bits for universal use
- Universal holder with stainless sleeve and strong permanent magnet

#### Bit-Check 7 Universal 1



Code	EAN		
	4013288		
05056295001	038166		20
		893/4/1 K 1x 1/4"x50	
		851/1 Z PH 1x PH 1x25; 1x PH 2x25	
		855/1 Z PZ 1x PZ 1x25; 1x PZ 2x25	
		800/1 Z 1x 1,0x5,5x25; 1x 1,2x6,5x25	

#### Bit-Check 7 Universal 1 SB



Code	EAN		
	4013288		
05073406001	036186		1
		893/4/1 K 1x 1/4"x50	
		851/1 Z PH 1x PH 1x25; 1x PH 2x25	
		855/1 Z PZ 1x PZ 1x25; 1x PZ 2x25	
		800/1 Z 1x 1.0x5.5x25; 1x 1.2x6.5x25	

### Bit-Check 7 Universal 4



Code	EAN		
	4013288		
05135810001	179265		20
		893/4/1 K 1x 1/4"x50	
		851/1 Z PH 1x PH 2x25	
		855/1 Z PZ 1x PZ 1x25; 1x PZ 2x25	
		867/1 TORX® 1x TX 15x25; 1x TX 20x25; 1x TX 25x25	

#### Bit-Check 7 PZ Universal 1



Code	EAN		
	4013288		
05056296001	038135		20
		893/4/1 K 1x 1/4"x50	
		855/1 Z PZ 2x PZ 1x25; 3x PZ 2x25; 1x PZ 3x25	



### Bit-Check 7 TX Universal 1

- Tough viscous bits for universal use
- Universal holder with stainless sleeve and strong permanent magnet

#### Bit-Check 7 TX Universal 1



Code	EAN		
05056294001	4013288 041500		20
		●● 893/4/1 K 1x 1/4"x50	
		♻️ 867/1 TORX® 1x TX 10x25; 1x TX 15x25; 1x TX 20x25; 1x TX 25x25; 1x TX 30x25; 1x TX 40x25	

#### Bit-Check 7 TX Universal 1 SB



Code	EAN		
05073404001	4013288 038111		1
		●● 893/4/1 K 1x 1/4"x50	
		♻️ 867/1 TORX® 1x TX 10x25; 1x TX 15x25; 1x TX 20x25; 1x TX 25x25; 1x TX 30x25; 1x TX 40x25	

### Bit-Check 7 TX BO Universal 1

- Tough viscous bits for universal use
- Universal holder with quick-release chuck for rapid bit change

#### Bit-Check 7 TX BO Universal 1



Code	EAN		
05056158001	4013288 033741		20
		●● 894/4/1 K 1x 1/4"x51	
		♻️ 867/1 Z TORX® BO 1x TX 10x25; 1x TX 15x25; 1x TX 20x25; 1x TX 25x25; 1x TX 30x25; 1x TX 40x25	

### Hex-Plus - lets hexagon socket screws last longer

Deformation of the screws is reduced

Above-average service life

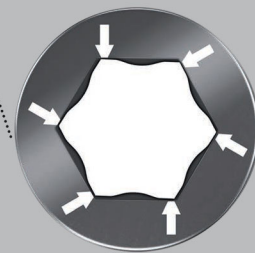

#### Bit-Check 7 Hex-Plus 1



Code	EAN		
05056168001	4013288 033840		20
		●● 895/4/1 K 1x 1/4"x52	
		○ 840/1 Z Hex-Plus 1x 2,0x25; 1x 2,5x25; 1x 3,0x25; 1x 4,0x25; 1x 5,0x25; 1x 6,0x25	



### Bit-Check 6 Universal 1

- Tough viscous bits for universal use
- The Torsion design absorbs torque peaks
- Prevents premature breakage of the drive tip

#### Bit-Check 6 Universal 1



Code	EAN		
05056474001	4013288 156143		20
		+	851/4 TZ PH 1x PH 1x50; 1x PH 2x50
		+	855/4 TZ PZ 1x PZ 1x50; 1x PZ 2x50
		●	800/4 Z 1x 1,0x5,5x50; 1x 1,2x6,5x50

#### Bit-Check 6 Universal 1 SB



Code	EAN		
05073635001	4013288 155276		1
		+	851/4 TZ PH 1x PH 1x50; 1x PH 2x50
		+	855/4 TZ PZ 1x PZ 1x50; 1x PZ 2x50
		●	800/4 Z 1x 1,0x5,5x50; 1x 1,2x6,5x50

### Bit-Check 6 Universal 2



Code	EAN		
05056473001	4013288 156136		20
		+	851/4 TZ PH 1x PH 2x50
		+	855/4 TZ PZ 1x PZ 1x50; 1x PZ 2x50
		●	867/4 Z TORX® 1x TX 15x50; 1x TX 20x50; 1x TX 25x50

#### Bit-Check 6 Universal 2 SB



Code	EAN		
05073638001	4013288 155245		1
		+	851/4 TZ PH 1x PH 2x50
		+	855/4 TZ PZ 1x PZ 1x50; 1x PZ 2x50
		●	867/4 Z TORX® 1x TX 15x50; 1x TX 20x50; 1x TX 25x50



### Bit-Check 6 TX Universal 1

- Tough viscous bits for universal use

#### Bit-Check 6 TX Universal 1



Code	EAN		
	4013288		
05056472001	156112		20
		867/4 Z TORX® 1x TX 10x50; 1x TX 15x50; 1x TX 20x50; 1x TX 25x50; 1x TX 30x50; 1x TX 40x50	

#### Bit-Check 6 TX Universal 1 SB



Code	EAN		
	4013288		
05073637001	155252	867/4 Z TORX® 1x TX 10x50; 1x TX 15x50; 1x TX 20x50; 1x TX 25x50; 1x TX 30x50; 1x TX 40x50	1

### Bit-Check 6 PZ Universal 1

6 50 mm-long Pozidriv bits tidily arranged in a minimum of space in a practical Bit-Check.

The tough viscous bits are suitable for universal use. Torsion design to combat premature wear.

#### Bit-Check 6 PZ Universal 1



Code	EAN		
	4013288		
05056471001	156105		20
		855/4 TZ PZ 2x PZ 1x50; 3x PZ 2x50; 1x PZ 3x50	

### Bit-Check 6 V Universal 1

6 50 mm-long bits tidily arranged in a minimum of space in a practical Bit-Check. Bits for square socket screws with holding function.

The wedging forces resulting from the contact pressure between the drive tip and the screw profile securely hold the screw on the tool. 1/4" hexagon, suitable for holders as per DIN ISO 1173-F 6.3.

#### Bit-Check 6 V Universal 1



Code	EAN		
	4013288		
05056478001	190802		10
		868/4 V 1x # 1x50; 3x # 2x50; 2x # 3x50	

### Bit-Check 30 Wood TX HF 1

Bits and holder set, particularly suitable for woodworking. With their special geometry and as per the Acument Intellectual Properties specification, the 867/1 TORX® HF bits hold TORX® screws securely on the tool!

This is particularly helpful in hard-to-reach work areas where the second hand cannot be used to hold the screw.

They are also suitable for Würth ASSY screws as well as Altenloh SPAX T-STAR plus screws.

With Take it easy tool finder: Colour coding by size. Rapidaptor holder for lightning-fast bit changes. The Bit-Check allows a quick overview of the available tools.

Unused bits are simply put back in the holder and will not be lost. Easy transport e.g. in the shirt pocket. The Bit-Check can be set up at the work place, which allows for quick access of the tools.

- Holding function for recessed TORX® screws
- Also suitable for Würth ASSY screws as well as Altenloh SPAX T-STAR plus screws

### Bit-Check 30 Wood TX HF 1



Code	EAN		
05057436001	4013288 226204		10
		●● 887/4 RR 1x 1/4"x57	
		⊕ 851/1 TZ 2x PH 2x25; 1x PH 3x25	
		⊕ 855/1 TH 3x PZ 1x25; 6x PZ 2x25; 2x PZ 3x25	
		⊕ 867/1 TORX® HF 2x TX 10x25; 2x TX 15x25; 4x TX 20x25; 4x TX 25x25; 2x TX 30x25; 1x TX 40x25 <sup>1)</sup>	

<sup>1)</sup>Pound-thru hexagonal; no Take it easy.

### Bit-Check 30 Wood TX HF 1 SB



Code	EAN		
05057437001	4013288 227522		1
<b>1x Bit-Check 30 Wood TX HF 1</b>			
		●● 887/4 RR 1x 1/4"x57	
		⊕ 851/1 TZ 2x PH 2x25; 1x PH 3x25	
		⊕ 855/1 TH 3x PZ 1x25; 6x PZ 2x25; 2x PZ 3x25	
		⊕ 867/1 TORX® HF 2x TX 10x25; 2x TX 15x25; 4x TX 20x25; 4x TX 25x25; 2x TX 30x25; 1x TX 40x25 <sup>1)</sup>	

<sup>1)</sup>Pound-thru hexagonal; not Take it easy.

### Bit-Check 30 Wood 1

- Ring magnet Rapidaptor, holder for holding even longer and heavier screws

### Bit-Check 30 Wood 1



Code	EAN		
05057433001	4013288 179807		1
		●● 887/4 RR 1x 1/4"x57	
		⊕ 851/1 TZ PH 2x PH 2x25; 1x PH 3x25	
		⊕ 855/1 TH PZ 3x PZ 1x25; 6x PZ 2x25; 2x PZ 3x25	
		⊕ 867/1 TZ TORX® 2x TX 10x25; 2x TX 15x25; 4x TX 20x25; 4x TX 25x25; 2x TX 30x25; 1x TX 40x25	

## Bit-Check 30 Wood 2

- Universal holder with stainless sleeve

### Bit-Check 30 Wood 2



Code	EAN		
05057432001	4013288 179845		10
		●○ 899/4/1 1x 1/4"x50	
		⊕ 851/1 Z PH 1x PH 2x25	
		⊕ 855/1 Z PZ 2x PZ 1x25; 5x PZ 2x25; 2x PZ 3x25	
		⊕ 867/1 TORX® 3x TX 10x25; 4x TX 15x25; 4x TX 20x25; 4x TX 25x25; 3x TX 30x25; 1x TX 40x25	

### Bit-Check 30 Wood 2 SB



Code	EAN		
05057438001	4013288 229625		1
		●○ 899/4/1 1x 1/4"x50	
		⊕ 851/1 Z 1x PH 2x25	
		⊕ 855/1 Z 2x PZ 1x25; 5x PZ 2x25; 2x PZ 3x25	
		⊕ 867/1 TORX® 3x TX 10x25; 4x TX 15x25; 4x TX 20x25; 4x TX 25x25; 3x TX 30x25; 1x TX 40x25	

## Bit-Check 12 Wood TX HF 1

Bits and holder set, particularly suitable for woodworking. With their special geometry and as per the Acument Intellectual Properties specification, the 867/1 TORX® HF bits hold TORX® screws securely on the tool!

This is particularly helpful in hard-to-reach work areas where the second hand cannot be used to hold the screw. They are also suitable for Würth ASSY screws as well as Altenloh SPAX T-STAR plus screws.

With Take it easy tool finder: Colour coding by size. Ring magnet Rapidaptor holding tool to hold long and heavy screws.

The Bit-Check allows a quick overview of the available tools. Unused bits are simply put back in the holder and will not be lost.

Easy transport e.g. in the shirt pocket. The Bit-Check can be set up at the work place, which allows for quick access of the tools.

- 867/1 TORX® HF bits with holding function for TORX® screws as per the Acument Intellectual Properties specification
- Also suitable for Würth ASSY screws as well as Altenloh SPAX T-STAR plus screws

### Bit-Check 12 Wood TX HF 1



Code	EAN		
05057435001	4013288 226198		10
		●○ 887/4 RR 1x 1/4"x57	
		⊕ 855/1 Z 1x PZ 1x25; 1x PZ 2x25	
		⊕ 867/1 TORX® HF 1x TX 10x25; 1x TX 15x25; 1x TX 20x25; 2x TX 25x25; 1x TX 30x25; 1x TX 40x25 <sup>1)</sup>	
		⊕ 867/1 TORX® 1x TX 20x25; 1x TX 25x25	

<sup>1)</sup>Pound-thru hexagonal; no Take it easy.

### Bit-Check 12 Wood TX HF 1 SB



Code	EAN		
05073641001	4013288 227515		1
<b>1x Bit-Check 12 Wood TX HF 1</b>			
		<ul style="list-style-type: none"> <li>●○ 887/4 RR 1x 1/4"x57</li> <li>⊕ 855/1 Z 1x PZ 1x25; 1x PZ 2x25</li> <li>⊕ 867/1 TORX® HF 1x TX 10x25; 1x TX 15x25; 1x TX 20x25; 2x TX 25x25; 1x TX 30x25; 1x TX 40x25<sup>1)</sup></li> <li>⊕ 867/1 TORX® 1x TX 20x25; 1x TX 25x25</li> </ul>	

<sup>1)</sup>Pound-thru hexagonal; not Take it easy.

### Bit-Check 12 Wood 1

- Ring magnet Rapidaptor, holder for holding even longer and heavier screws

### Bit-Check 12 Wood 1



Code	EAN		
05057423001	4013288 179876		10
		<ul style="list-style-type: none"> <li>●○ 887/4 RR 1x 1/4"x57</li> <li>⊕ 855/1 TH PZ 1x PZ 1x25; 2x PZ 2x25; 1x PZ 3x25</li> <li>⊕ 851/1 TH PH 1x PH 2x25</li> <li>⊕ 867/1 TORX® 1x TX 10x25; 1x TX 15x25; 1x TX 20x25; 1x TX 25x25; 1x TX 30x25; 1x TX 40x25</li> </ul>	

### Bit-Check 12 Wood 1 SB



Code	EAN		
05136390001	4013288 214010		1
		<ul style="list-style-type: none"> <li>●○ 887/4 RR 1x 1/4"x57</li> <li>⊕ 851/1 TH PH 1x PH 2x25</li> <li>⊕ 855/1 TH PZ 1x PZ 1x25; 2x PZ 2x25; 1x PZ 3x25</li> <li>⊕ 867/1 TORX® 1x TX 10x25; 1x TX 15x25; 1x TX 20x25; 1x TX 25x25; 1x TX 30x25; 1x TX 40x25</li> </ul>	

### Bit-Check 12 Wood 2

- Universal holder with stainless sleeve

### Bit-Check 12 Wood 2



Code	EAN		
05057422001	4013288 179890		10
		<ul style="list-style-type: none"> <li>●○ 899/4/1 1x 1/4"x50</li> <li>⊕ 851/1 Z PH 1x PH 2x25</li> <li>⊕ 855/1 Z PZ 1x PZ 1x25; 2x PZ 2x25; 1x PZ 3x25</li> <li>⊕ 867/1 TORX® 1x TX 10x25; 1x TX 15x25; 1x TX 20x25; 1x TX 25x25; 1x TX 30x25; 1x TX 40x25</li> </ul>	



### Bit-Check 12 Wood 2 SB



Code	EAN			
05136391001	214027		<b>899/4/1</b> 1x 1/4"x50	1
			<b>851/1 Z PH</b> 1x PH 2x25	
			<b>855/1 Z PZ</b> 1x PZ 1x25; 2x PZ 2x25; 1x PZ 3x25	
			<b>867/1 TORX®</b> 1x TX 10x25; 1x TX 15x25; 1x TX 20x25; 1x TX 25x25; 1x TX 30x25; 1x TX 40x25	

### Bit-Check 6 Wood TX HF 1

Bit-Set, particularly suitable for woodworking. With their special geometry and as per the Acument Intellectual Properties specification, the 867/4 TORX® HF bits hold TORX® screws securely on the tool!

This is particularly helpful in hard-to-reach work areas where the second hand cannot be used to hold the screw. They are also suitable for Würth ASSY screws as well as Altenloh SPAX T-STAR plus screws.

With Take it easy tool finder: Colour coding by size.

The Bit-Check allows a quick overview of the available tools. Unused bits are simply put back in the holder and will not be lost.

Easy transport e.g. in the shirt pocket. The Bit-Check can be set up at the work place, which allows for quick access of the tools.

- Particularly for wood applications
- For TORX® socket screws
- Holding function for TORX® screws
- Also suitable for Würth ASSY screws as well as Altenloh SPAX T-STAR plus screws
- 50 mm-long bits

### Bit-Check 6 Wood TX HF 1



Code	EAN			
05056470001	226181			20
			<b>867/4 TORX® HF</b> 2x TX 20x50; 2x TX 25x50; 1x TX 30x50; 1x TX 40x50 <sup>1)</sup>	

<sup>1)</sup>Pound-thru hexagonal; no Take it easy.

### Bit-Check 6 Wood TX HF 1 SB



Code	EAN			
05073639001	227508			1
<b>1x Bit-Check 6 Wood TX HF 1</b>				
			<b>867/4 TORX® HF</b> 2x TX 20x50; 2x TX 25x50; 1x TX 30x50; 1x TX 40x50 <sup>1)</sup>	

<sup>1)</sup>Pound-thru hexagonal; not Take it easy.

## Bit-Check 30 Metal 1

- Tough viscous bits for universal use
- Universal holder with stainless sleeve and strong permanent magnet

### Bit-Check 30 Metal 1



Code	EAN		
	4013288		
05057434001	179838		10
		899/4/1 1x 1/4"x50	
		851/1 Z PH 3x PH 1x25; 3x PH 2x25; 2x PH 3x25	
		855/1 Z PZ 3x PZ 1x25; 3x PZ 2x25; 3x PZ 3x25	
		867/1 TORX® 1x TX 10x25; 1x TX 15x25; 1x TX 20x25; 1x TX 25x25; 1x TX 30x25; 1x TX 40x25	
		800/1 Z 1x 0,6x4,5x25; 1x 1,0x5,5x25; 1x 1,2x6,5x25	
		840/1 Z Hex-Plus 1x 4,0x25; 1x 5,0x25; 1x 6,0x25	

## Bit-Check 30 Metal 1 SB



Code	EAN		
	4013288		
05057440001	229632	899/4/1 1x 1/4"x50	1
		851/1 Z 3x PH 1x25; 3x PH 2x25; 2x PH 3x25	
		855/1 Z 3x PZ 1x25; 3x PZ 2x25; 3x PZ 3x25	
		867/1 TORX® 1x TX 10x25; 1x TX 15x25; 1x TX 20x25; 1x TX 25x25; 1x TX 30x25; 1x TX 40x25	
		800/1 Z 1x 0.6x4.5x25; 1x 1.0x5.5x25; 1x 1.2x6.5x25	
		840/1 Z 1x 4.0x25; 1x 5.0x25; 1x 6.0x25	



### Bit-Check 12 Metal 1



Code	EAN			
	4013288			
05057424001	179883		10	
		899/4/1 1x 1/4"x50		
		851/1 Z PH 1x PH 1x25; 1x PH 2x25		
		855/1 Z PZ 1x PZ 1x25; 1x PZ 2x25		
		867/1 TORX® 1x TX 15x25; 1x TX 20x25; 1x TX 25x25; 1x TX 30x25		
		840/1 Z Hex-Plus 1x 3,0x25; 1x 4,0x25; 1x 5,0x25		

### Bit-Check 12 Metal 1 SB



Code	EAN			
	4013288			
05136393001	214003		1	
		899/4/1 1x 1/4"x50		
		851/1 Z PH 1x PH 1x25; 1x PH 2x25		
		855/1 Z PZ 1x PZ 1x25; 1x PZ 2x25		
		867/1 TORX® 1x TX 15x25; 1x TX 20x25; 1x TX 25x25; 1x TX 30x25		
		840/1 Z Hex-Plus 1x 3,0x25; 1x 4,0x25; 1x 5,0x25		

### 843 Stepped drill bits, 4-20 mm

9 drill steps increasing by 2 mm for material with a maximum thickness of 4.5 mm. Comes with edge breaker for 1 mm sheet metal. 1/4" hexagon, suitable for holders as per DIN ISO 1173-D 6.3.

### 843 Stepped drill bits, 4-20 mm



Code	EAN					
05104672001	117632	75,0				1

### 844 Single Tap Bits

To cut metric threads. The hexagonal shaft ensures very good power transfer. The finely-tuned material elasticity provides for great durability.

Perfect chip removal and a low tilt risk.

1/4" hexagon, suitable for holders as per DIN ISO 1173-D 6.3.

### 844 Single Tap Bits



Code	EAN					
05104666001	117571	3,0	10,00	33,0	M 3	1
05104667001	117588	4,0	11,00	35,0	M 4	1
05104668001	117595	5,0	12,50	36,0	M 5	1
05104669001	117601	6,0	18,00	40,0	M 6	1
05104670001	117618	8,0	20,00	40,0	M 8	1
05104671001	117625	10,0	20,00	40,0	M 10	1



### 844/7 Tap Bits Set

Rapidaptor universal holder for bits with 1/4" hexagon drive.  
Non-magnetic design.

#### 844/7 Tap Bits Set



Code	EAN			
05104754001	4013288 233042			1
		●● 888/4/1 K 1x 1/4"x50		
		● 844 1x 3,0x33,0; 1x 4,0x35,0; 1x 5,0x36,0; 1x 6,0x40,0; 1x 8,0x40,0; 1x 10,0x40,0		

### 845 1-flute Countersink Bits

1-flute countersink bit by Wera. For countersinking and deburring. The hexagon shaft ensures very good power transfer, vibration-free and score-free working.

Perfect chip removal and long service life. 1/4" hexagon, suitable for holders as per DIN ISO 1173-D 6.3.

#### 845 1-flute Countersink Bits



Code	EAN	●	↓	↓	●		
	4013288	mm	mm	mm			
05104660001	117519	6,30	21,00	32,0	M 3		1
05104661001	117526	8,30	21,00	32,0	M 4		1
05104662001	117533	10,40	21,00	34,0	M 5		1
05104663001	117540	12,40	21,00	36,0	M 6		1
05104664001	117557	16,50	22,00	40,0	M 8		1
05104665001	117564	20,50	22,00	43,0	M 10		1

### 816 R

Bit holder with Rapidaptor quick-release chuck for bits with 1/4" hexagon drive.

### 888/4/1 K

Rapidaptor universal holder for bits with 1/4" hexagon drive.  
Non-magnetic design.

#### 845/8 1-flute Countersink Bits Set



Code	EAN			
05104655001	4013288 119285			1
		● 816 R 1x 1/4"x119		
		●● 888/4/1 K 1x 1/4"x50		
		● 845 1x 6,30x32,0; 1x 8,30x32,0; 1x 10,40x34,0; 1x 12,40x36,0; 1x 16,50x40,0; 1x 20,50x43,0		

### 846 3-flute Countersink Bit

3-flute countersink bit for deburring, chamfering and countersinking. A finely-tuned material elasticity provides for great durability.

Perfect chip removal and a low tilt risk ensure pleasant working. Cutting section as per DIN 335-C, 90° with 3 cutters. 1/4" hexagon, suitable for holders with take-up as per DIN ISO 1173-D 6.3.

#### 846 3-flute Countersink Bit



Code	EAN	●	↓	↓	↓		
	4013288	mm	mm	mm			
05104630001	101440	6,30	20,00	31,0	M 3		1
05104631001	101457	8,30	20,00	31,0	M 4		1
05104632001	101464	10,40	20,00	34,0	M 5		1
05104633001	101471	12,40	20,00	35,0	M 6		1
05104634001	101488	16,50	20,00	40,0	M 8		1
05104635001	101495	20,50	20,00	41,0	M 10		1

### 816 R

Bit holder with Rapidaptor quick-release chuck for bits with 1/4" hexagon drive.

### 888/4/1 K

Rapidaptor universal holder for bits with 1/4" hexagon drive.  
Non-magnetic design.

### 846/8 3-flute Countersink Bits Set



Code	EAN		
05104650001	111678		1
		<ul style="list-style-type: none"> <li>● <b>816 R</b> 1x 1/4"x119</li> <li>●● <b>888/4/1 K</b> 1x 1/4"x50</li> <li>●●● <b>846 HSS</b> 1x 6,30x31,0; 1x 8,30x31,0; 1x 10,40x34,0; 1x 12,40x35,0; 1x 16,50x40,0; 1x 20,50x41,0</li> </ul>	

### 847 HSS Combined Tap Bits

Combination tapping drill bits for drilling, tapping and deburring. Made out of high speed steel (HSS). A finely-tuned material elasticity provides for great durability.

The very good centring properties, perfect chip removal and a low tilt risk ensure pleasant working. The hexagonal shaft ensures very good power transfer. Drive: 1/4" hexagon, suitable for holders with take-up as per DIN ISO 1173-D 6.3.

### 847 HSS Combined Tap Bits



Code	EAN	mm	mm	mm			
05104640001	101501	2,5	12,00	36,0	M 3		1
05104641001	101518	3,3	12,00	39,0	M 4		1
05104642001	101525	4,2	12,00	41,0	M 5		1
05104643001	101532	5,0	12,00	44,0	M 6		1
05104644001	101549	6,8	12,00	51,0	M 8		1
05104645001	101556	8,5	12,00	59,0	M 10		1

### 888/4/1 K Rapidaptor Universal Bit holder

- Non-magnetic design

### 847/7 Set Combination Drill Bits Set



Code	EAN		
05104751001	233035		1
		<ul style="list-style-type: none"> <li>●● <b>888/4/1 K</b> 1x 1/4"x50</li> <li>●●● <b>847 HSS</b> 1x 2,5x36,0; 1x 3,3x39,0; 1x 4,2x41,0; 1x 5,0x44,0; 1x 6,8x51,0; 1x 8,5x59,0</li> </ul>	

### 848 HSS Metal Twist Drill Bits

Metal twist drill bits for precise drilling in metal. Made out of high speed steel (HSS). A finely-tuned material elasticity provides for a long service life. Very good concentricity.

Tough viscous tempered bits ensure a particularly long service life. The hexagonal shaft ensures very good power transfer.

Drive: 1/4" hexagon, suitable for holders as per DIN ISO 1173-D 6.3.

#### 848 HSS Metal Twist Drill Bits



	EAN							
Code	4013288	mm	mm	mm				
05104610001	101310	3,0	16,00	38,0				1
05104611001	101327	3,1	18,00	40,0				1
05104612001	101334	3,3	18,00	40,0				1
05104613001	101341	4,0	20,00	44,0				1
05104614001	101358	4,1	20,00	44,0				1
05104615001	101365	4,2	20,00	45,0				1
05104616001	101372	5,0	26,00	50,0				1
05104617001	101389	5,1	26,00	50,0				1
05104618001	101396	6,0	26,00	50,0				1
05104619001	101402	6,8	30,00	50,0				1
05104620001	101419	8,0	32,00	51,0				1
05104621001	101426	8,5	33,00	53,0				1
05104622001	101433	10,0	38,00	54,0				1

### 849 HSS Twist Wood Drill Bits

Wood twist drill bits for precise, splinter-free drilling in soft wood, hard wood and laminated panel material. Made out of high speed steel (HSS).

The hexagonal shaft ensures very good power transfer. A finely-tuned material elasticity provides for a long service life. Very good concentricity. 1/4" drive suitable for holders as per DIN ISO 1173-D 6.3.

#### 849 HSS Twist Wood Drill Bits



	EAN							
Code	4013288	mm	mm	mm				
05104600001	101259	3,0	32,00	70,0				1
05104601001	101266	4,0	32,00	74,0				1
05104602001	101273	5,0	43,00	85,0				1
05104603001	101280	6,0	45,00	95,0				1
05104604001	101297	8,0	60,00	110,0				1
05104605001	101303	10,0	70,00	120,0				1

### 848/851/867/19 Metal Twist Drill Bits and Bits Set

19-piece metal twist drill bit and bit set. High quality metal twist drill bits for precise drilling in metal.

Made out of high speed steel (HSS). A finely-tuned material elasticity provides for great durability.

Very good concentricity. The hexagonal shaft ensures very good power transfer. Tough viscous bits for universal use.

Drive: 1/4" hexagon, suitable for holders as per DIN ISO 1173-D 6.3. Includes robust belt pouch for secure storage.

#### 848/851/867/19 Metal Twist Drill Bits and Bits Set



Code	EAN		
05104652001	111654		1
		<b>888/4/1 K</b> 1x 1/4"x50	
		<b>851/1 TZ PH</b> 2x PH 1x25; 3x PH 2x25; 1x PH 3x25	
		<b>848 HSS</b> 1x 3,0x38,0; 1x 4,0x44,0; 1x 4,2x45,0; 1x 5,0x50,0; 1x 6,0x50,0; 1x 8,0x51,0	
		<b>867/1 TORX®</b> 1x TX 10x25; 1x TX 15x25; 1x TX 20x25; 1x TX 25x25; 1x TX 30x25; 1x TX 40x25	



### 849/855/867/18 Wood Twist Drill Bits and Bits Set

18-piece wood twist drill bit and bit set. High quality, metal twist drill bits for precise, splinter-free drilling in soft wood, hard wood and laminated panel material.

Made out of high speed steel (HSS). A finely-tuned material elasticity provides for great durability. Very good concentricity.

The hexagonal shaft ensures very good power transfer. The Rapidaptor universal holder ensures rapid bit change without any extra tools. Drive: 1/4" hexagon, suitable for holders with take-up as per DIN ISO 1173-D 6.3.

### 849/855/867/18 Wood Twist Drill Bits and Bits Set



Code	EAN			
05104653001	4013288 111661			1
		● ○ 889/4/1 K 1x 1/4"x50		
		⊗ 849 HSS 1x 3,0x70,0; 1x 4,0x74,0; 1x 5,0x85,0; 1x 6,0x95,0; 1x 8,0x110,0		
		⊕ 855/1 TH PZ 2x PZ 1x25; 3x PZ 2x25; 1x PZ 3x25		
		⊗ 867/1 TORX® 1x TX 10x25; 1x TX 15x25; 1x TX 20x25; 1x TX 25x25; 1x TX 30x25; 1x TX 40x25		

### Patio construction set T 1

Compact Wera tool set with the 17 most common screwdriving tools for patio construction. Bits in stainless steel design prevent extraneous rust.

With extra smart bit holder, which enables a uniform depth thanks to the variable screw depth limitation, and prevents damage to decking with the fitted felt ring.

- High-quality 17-piece tool set for evenly flush countersunk screw heads for decking in patio construction
- Bit holder with adjustable screw depth limitation and protective felt ring for surface protection
- 15 bits (TORX®, PH, PZ) made from stainless steel to prevent extraneous rust plus 3888/4/1 K Rapidaptor stainless steel bit holder
- Take it easy tool finder: colour coding according to profile and size
- Compact folding bag with Wera 2go compatibility incl. 4 spare felt rings

### Patio construction set T 1



Code	EAN			
05134021001	4013288 219510			1
		● ○ 881/4/1 1x 1/4"x90 <sup>1)</sup>		
		● ○ 3888/4/1 K 1x 1/4"x50		
		⊕ 3851/1 TS PH 1x PH 1x25; 1x PH 2x25; 1x PH 3x25		
		⊕ 3855/1 TS PZ 1x PZ 1x25; 2x PZ 2x25; 1x PZ 3x25		
		⊗ 3867/1 TS TORX® 1x TX 10x25; 1x TX 15x25; 1x TX 20x25; 1x TX 25x25; 1x TX 30x25; 1x TX 40x25		
		⊗ 3867/1 TS P TORX® 2x TX 25x25		
		9201 4x 27,0		

<sup>1)</sup>The spare part kit with 5x felt rings can be ordered with the code number 05130003001.

### Bit-Check 10 Drywall 1

Bit-Check for drywall construction. High quality spacer out of aluminium; the screwdriving depth can be infinitely adjusted and allows the flush-mounting of screws; 9 drywall bits with modified output shaft, 25 mm in length.

#### Bit-Check 10 Drywall 1

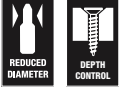

Code	EAN			
05136011001	4013288 178657			1
		●●	896/4/1 1x 1/4"x50	
		+	851/1 RZ PH 9x PH 2x25	

### Bit-Check 6 SHK 1 SB

6 Wera bits (50 mm length) neatly arranged in the smallest of spaces in the practical Bit-Check. Particularly suitable for plumbing, heating and air conditioning; Bit-Checks allow a quick overview of the available tools. Unused bits are simply put back in the holder and will not be lost. Easy transport e.g. in your shirt pocket. The tough bits are suitable for universal use.

- Included bits particularly suitable for HVAC applications
- Tough viscous bits for universal use
- The tough design of the bits prevents the tip from breaking prematurely
- Hex-Plus allows socket head screws to live longer
- 50 mm-long bits
- Upright positionable, multi-component Bit-Check
- Bit-Check plastic material ensures robustness and durability

#### Bit-Check 6 SHK 1 SB



Code	EAN			
05073631001	4013288 227997			1
		+	851/4 TZ 1x PH 1x50	
		●	867/4 Z TORX® 1x TX 15x50; 1x TX 20x50; 1x TX 25x50	
		○	840/4 Z 1x 5.0x50; 1x 6.0x50 <sup>1)</sup>	

<sup>1)</sup>Hexagonal blade





# Torque Tools

### Series 7400 Krafftform adjustable torque screwdrivers with Rapidaptor quick-release chuck

Variable torque setting option with highest precision. Simple adjustment of the required torque value without any special tools. Easy-to-read scale value; audible click signal. Rapidaptor quick-release technology for rapid bit change. Unlimited torque to loosen seized screws.

Multi-component Krafftform handle with hard and soft zones for high working speeds, whilst being easy on the hand.

Suitable for bits with 1/4" hexagon head drive as per DIN ISO 1173-C 6.3 and E 6.3 (ISO 1173).

### Series 7400 Krafftform adjustable torque screwdrivers (0.1-3.0 Nm) with Rapidaptor quick-release chuck



Code	EAN	Art.No.						
Code	EAN	Art.No.		Nm	Nm	mm	mm	
05074770001 <sup>1)</sup>	179012	7430	1/4"	0,10-0,34	0,015	89	142	1
05074772001 <sup>1)</sup>	179128	7431	1/4"	0,30-1,00	0,05	89	142	1
05074774001 <sup>1)</sup>	179135	7432	1/4"	0,90-1,50	0,05	89	142	1
05074700001	100641	7440	1/4"	0,3-1,2	0,05	105	155	1
05074701001	100658	7441	1/4"	1,2-3,0	0,10	105	155	1

<sup>1)</sup> With attachable magnifying glass, significantly improving readability.

### Series 7400 Krafftform adjustable torque screwdrivers (2.5-29.0 in. lbs.) with Rapidaptor quick-release chuck



Code	EAN	Art.No.						
Code	EAN	Art.No.		in. lbs.	in. lbs.	mm	mm	
05074710001	102881	7445	1/4"	2,5-11,5	0,5	105	155	1
05074711001	102898	7446	1/4"	11,0-29,0	1,0	105	155	1

### Series 7400 Krafftform pistol grip, adjustable torque screwdrivers (3.0-8.8 Nm) with Rapidaptor quick-release chuck



Code	EAN	Art.No.						
Code	EAN	Art.No.		Nm	Nm	mm	mm	
05074702001	101730	7442	1/4"	3,0-6,0	0,25	150	100	1
05074705001	119308	7443	1/4"	4,0-8,8	0,40	150	100	1

### Series 7400 Krafftform pistol grip, adjustable torque screwdrivers (25.0-55.0 in. lbs.) with Rapidaptor quick-release chuck

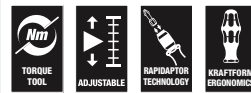

Code	EAN	Art.No.						
Code	EAN	Art.No.		in. lbs.	in. lbs.	mm	mm	
05074712001	102904	7447	1/4"	25,0-55,0	2,5	150	100	1



## 9524 Photovoltaic mounting tool set 1

7-piece tool set for installing photovoltaic systems. One adjustable torque screwdriver (pistol handle) 7442 for the measuring range 3.0-6.0 Nm. Digital torque value display. Reliable slip-over mechanism and audible signal when the set torque is reached. One 889/4/1 F Rapidaptor bitholding screwdriver with fast-rotating function for a particularly quick return movement without having to remove the tool during clockwise torque operation. One 6003 Joker ring spanner. The special open end geometry expands the placement possibilities of the tool which makes the ring spanner particularly suitable for narrow spaces.

2 installation tools for MC4 solar connectors (Multi-Contact). One socket 1/2" (with side wire cutout) size 17 for installing panel connectors, one tool shaft (adapter 1/4" to 1/2") for manually operated socket wrench inserts.

- Screwdriving tool set for installing photovoltaic systems
- Includes 2x 9108 installation tools for MC4 solar connectors (Multi-Contact)
- Includes 7442 adjustable torque screwdriver (3.0-6.0 Nm) with pistol handle
- Includes Rapidaptor 889/4/1 F bitholder with fast-rotating function for a particularly quick return movement without having to remove the tool during clockwise torque operation
- Includes Joker 6003 ring spanner, particularly suitable for narrow spaces; the special open end geometry expands the placement possibilities of the tool
- Includes 1/2" socket (with side wire cutout) size 17 for installing panel connectors
- Includes tool shaft 870/4 (adapter 1/4" hexagon to 1/2" square head) for manually operated 1/2" socket wrench inserts

## 9524 Photovoltaic mounting tool set 1



Code	EAN		
05136043001	4013288 228017		1
		● 7400 pistol grip 1x 7442, 3,0-6,0 Nm	
		● 8790 HMC Deep with cutout 1x 17,0x76,0	
		○ 870/4 A 1x 1/4"x1/2"x72	
		● 889/4/1 F 1x 1/4"x64	
		6003 Joker 1x 17x190	
		9108 2x 115	
		Hook and Loop Fastener Strip 120 1x 50,0x120,0	

### 7443/12 Assembly set for tyre pressure control systems

12-piece tool set for the proper assembly and disassembly of tyre pressure control systems. Comes with torque technology for controlled screw tightening. Hand tool with multi-component Kraftform handle for high working speeds and ergonomic working. Five pre-set tools to connect the union nut with the screw and to fasten the sensor component to the valve.

Two pre-set valve insertion tools with 0.25 and 0.45 Nm. An adjustable Kraftform pistol handle for torque values of between 4.0 and 8.8 Nm. Suitable for all customary tyre pressure control systems. Dependable fastening thanks to distinctly coloured marking of the pre-set torque values (Beru/Huf®: TX 10 yellow 1.25 Nm; Schrader®: TX 10 green 1.4 Nm; Cup®/RTS®: TX 20 grey 2.0 Nm).

Two TX bits with holding function, socket adaptor, two sockets plus a valve dolly (for applications up to 4.5 Nm). Suitable for tyre control, systems from e.g. Schrader®, Alligator®, VDO®. The pre-set torque screwdriver fixed at 3.3 Nm actuates both the union nut as well as the connecting screw on the sensors of the Alligator system. Additionally included: socket adaptor, two bits, valve dolly (for applications up to 4.5 Nm).

### 7443/12 Assembly set for tyre pressure control systems

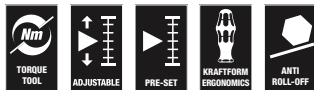

Code	EAN		
05074746001	178404		1
		● 7400 pistol grip 1x 7443, 4,0-8,8 Nm	
		● Series 7400 Kraftform torque screwdrivers with a factory pre-set measurement value 1x 7464, 3,3 Nm, 3,0-6,0 Nm	
		⊛ 300 TX 1x TX 10x1,25; 1x TX 10x1,4	
		● 790 A/50 1x 11,0x50,0; 1x 12,0x50,0	
		⊛ 867/4 TORX® HF 1x TX 15x50; 1x TX 20x50	
		○ 870/1 1x 1/4"x25 <sup>1)</sup>	
		● 300 V 1x 0,25; 1x 0,45	
		○ 327 1x 32x70	

<sup>1)</sup>With friction ball; for manual nut spinner sockets

### 7440/41 Kraftform torque screwdriver set 0.3-3.0 Nm

Wera torque screwdriver set. Two torque screwdrivers with variable torque setting option with highest precision.

Simple adjustment of the required torque value without any special tools. Easy-to-read scale value.

Rapidaptor quick-release technology for rapid bit change.

Unlimited torque to loosen seized screws. Multi-component Kraftform handle with hard and soft zones for high working speeds, whilst being easy on the hand.

Includes bit assortment in a high quality and stable plastic case.

### 7440/41 Kraftform torque screwdriver set 0.3-3.0 Nm



Code	EAN		
05074738001	112354		1
		● 7400 1x 7440, 1/4", 0,3-1,2 Nm; 1x 7441, 1/4", 1,2-3,0 Nm	
		⊛ 867/1 TZ TORX® 1x TX 6x25; 1x TX 7x25; 1x TX 8x25; 1x TX 9x25; 1x TX 10x25; 1x TX 15x25; 1x TX 20x25; 1x TX 25x25; 1x TX 30x25	
		⊛ 867/1 IP TORX PLUS® 1x 6 IPx25; 1x 7 IPx25; 1x 8 IPx25; 1x 9 IPx25; 1x 10 IPx25; 1x 15 IPx25; 1x 20 IPx25; 1x 25 IPx25; 1x 30 IPx25	
		○ 840/1 Z Hex-Plus 1x 2,0x25; 1x 2,5x25; 1x 3,0x25; 1x 4,0x25; 1x 5,0x25; 1x 6,0x25	

### 7440/41/42 Kraftform torque screwdriver set 0.3-6.0 Nm



Code	EAN		
05074739001	4013288 113924		1
		● <b>7400</b> 1x 7440, 0,3-1,2 Nm; 1x 7441, 1,2-3,0 Nm	
		● <b>7400 pistol grip</b> 1x 7442, 3,0-6,0 Nm	
		✦ <b>867/1 TZ TORX®</b> 1x TX 6x25; 1x TX 7x25; 1x TX 8x25; 1x TX 9x25; 1x TX 10x25; 1x TX 15x25; 1x TX 20x25; 1x TX 25x25; 1x TX 30x25	
		✦ <b>867/1 IP TORX PLUS®</b> 1x 6 IPx25; 1x 7 IPx25; 1x 8 IPx25; 1x 9 IPx25; 1x 10 IPx25; 1x 15 IPx25; 1x 20 IPx25; 1x 25 IPx25; 1x 30 IPx25	
		○ <b>840/1 Z</b> 1x 2,0x25; 1x 2,5x25; 1x 3,0x25; 1x 4,0x25; 1x 5,0x25; 1x 6,0x25	

### 7445/46/47 Kraftform torque screwdriver set 2.5-55.0 in. lbs.



Code	EAN		
05350451001	4013288 161383		1
		● <b>7400 Imperial</b> 1x 7445, 2,5-11,5 in. lbs.; 1x 7446, 11,0-29,0 in. lbs.	
		● <b>7400 Imperial pistol grip</b> 1x 7447, 25,0-55,0 in. lbs.	
		✦ <b>867/1 TZ TORX®</b> 1x TX 6x25; 1x TX 7x25; 1x TX 8x25; 1x TX 9x25; 1x TX 10x25; 1x TX 15x25; 1x TX 20x25; 1x TX 25x25; 1x TX 30x25	
		✦ <b>867/1 IP TORX PLUS®</b> 1x 6 IPx25; 1x 7 IPx25; 1x 8 IPx25; 1x 9 IPx25; 1x 10 IPx25; 1x 15 IPx25; 1x 20 IPx25; 1x 25 IPx25; 1x 30 IPx25	
		○ <b>840/1 Z</b> 1x 2,0x25; 1x 2,5x25; 1x 3,0x25; 1x 4,0x25; 1x 5,0x25; 1x 6,0x25	

### 7443/61/9 Assembly set for tyre pressure control systems

9-piece tool set for the proper assembly and disassembly of tyre pressure control systems. Comes with torque technology for controlled screw tightening.

Hand tool with multi-component Kraftform handle for high working speeds and ergonomic working. Two pre-set tools to connect the union nut with the screw and to fasten the sensor component to the valve.

An adjustable Kraftform pistol handle for torque values of between 4.0 and 8.8 Nm. Two TX bits with holding function, socket adaptor, two sockets plus a valve dolly (for applications up to 4.5 Nm). Suitable for tyre control, systems from e.g. Schrader®, Alligator®, VDO®.

### 7443/61/9 Assembly set for tyre pressure control systems

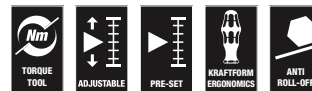

Code	EAN		
05074745001	4013288 168818		1
		● <b>Series 7400 Kraftform torque screwdrivers with a factory pre-set measurement value</b> 1x 7461, 1,2 Nm, 1,2-3,0 Nm <sup>1)</sup>	
		● <b>7400 pistol grip</b> 1x 7443, 4,0-8,8 Nm	
		✦ <b>300 TX</b> 1x TX 10x1,4	
		○ <b>870/1</b> 1x 1/4"x25 <sup>2)</sup>	
		● <b>790 A/50</b> 1x 11,0x50,0; 1x 12,0x50,0	
		✦ <b>867/4 TORX® HF</b> 1x TX 15x50; 1x TX 20x50	
		○ <b>327</b> 1x 32x70	

<sup>1)</sup>The preset torque can be changed. However, this requires the use of special tools and Torque Test Equipment. Please contact the Wera Torque Service.

<sup>2)</sup>With friction ball; for manual nut spinner sockets

### 1430 Kraftform Micro ESD adjustable torque screwdrivers (0.02-0.11 Nm) with quick-release chuck

- ESD-safe tool thanks to surface resistance of  $\leq 10^9$  Ohm
- Suitable for bits with 4 mm halfmoon and 4 mm HIOS drive
- Applications e.g. on smartphones, mobile phones, cameras, electronic equipment

### 1430 Kraftform Micro ESD adjustable torque screwdrivers (0.02-0.11 Nm) with quick-release chuck



Code	EAN	Art.No.	Nm	Nm	mm	mm	mm	mm	mm
05074802001 <sup>1)</sup>	179043	1430 ESD	0,02-0,06	0,0025	141	5 7/16"			1
05074804001 <sup>1)</sup>	179104	1431 ESD	0,05-0,11	0,005	141	5 7/16"			1

<sup>1)</sup> With attachable magnifying glass, significantly improving readability.

### Series 7400 Kraftform ESD adjustable torque screwdrivers (0.1-3.0 Nm) with Rapidaptor quick-release chuck

- ESD-safe tool thanks to surface resistance of  $\leq 10^9$  Ohm

### Series 7400 Kraftform ESD adjustable torque screwdrivers (0.1-3.0 Nm) with Rapidaptor quick-release chuck



Code	EAN	Art.No.	Nm	Nm	mm	mm	mm	mm	mm
05074780001 <sup>1)</sup>	179159	7430 ESD	1/4"	0,10-0,34	0,015	89	142	1	
05074782001 <sup>1)</sup>	179166	7431 ESD	1/4"	0,30-1,00	0,05	89	142	1	
05074784001 <sup>1)</sup>	179173	7432 ESD	1/4"	0,90-1,50	0,05	89	142	1	
05074730001	106964	7440 ESD	1/4"	0,3-1,2	0,05	105	155	1	
05074731001	106971	7441 ESD	1/4"	1,2-3,0	0,10	105	155	1	

<sup>1)</sup> With attachable magnifying glass, significantly improving readability.

### Series 7400 Kraftform ESD adjustable torque screwdrivers (2.5-29.0 in. lbs.) with Rapidaptor quick-release chuck

- ESD-safe tool thanks to surface resistance of  $\leq 10^9$  Ohm

### Series 7400 Kraftform ESD adjustable torque screwdrivers (2.5-29.0 in. lbs.) with Rapidaptor quick-release chuck

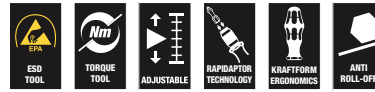

Code	EAN	Art.No.	in. lbs.	in. lbs.	mm	mm	mm	mm
05074733001	106988	7445 ESD	1/4"	2,5-11,5	0,5	105	155	1
05074734001	106995	7446 ESD	1/4"	11,0-29,0	1,0	105	155	1

### Series 7400 Kraftform ESD adjustable torque screwdrivers (0.1-1.0 Nm)

- ESD-safe tool thanks to surface resistance of  $\leq 10^9$  Ohm
- Suitable for bits with 4 mm halfmoon and 4 mm HIOS drive

### Series 7400 Kraftform ESD adjustable torque screwdrivers (0.1-1.0 Nm)



Code	EAN	Art.No.	Nm	Nm	mm	mm	mm	mm
05074786001 <sup>1)</sup>	179036	7435 ESD	0,10-0,34	0,015	89	142	5 7/16"	1
05074788001 <sup>1)</sup>	179029	7436 ESD	0,30-1,00	0,05	89	142	5 7/16"	1

<sup>1)</sup> With attachable magnifying glass, significantly improving readability.

### Series 7400 Kraftform Torque Screwdrivers, with a factory pre-set measurement value

Wera torque screwdriver. With a factory pre-set torque value set to the smallest scale value. For all applications, where the same constant torque and repeat accuracy are required.

The torque can be changed with an extra tool within the measuring range (re-calibration kit can be ordered with the code number 05137003001).

Afterwards you can check the set value using an off-the-shelf torque tester. Unlimited loosening torque for slackening stuck screws. Rapidaptor quick-release technology for rapid bit changes.

Suitable for bits with a 1/4" external hexagon drive as per DIN ISO 1173-C 6.3 and E 6.3 (ISO 1173). Multi-component Kraftform handle with hard and soft zones for high working speeds, whilst being easy on the hand.

Please note: 1 Ncm = 0.01 Nm.

### 7400 series Kraftform Torque screwdrivers, with factory pre-set value (0.1-1.5 Nm) and Rapidaptor quick-release chuck, handle size 89 mm



Code	EAN	Art.No.	Hex Drive	Pre-Set	Measuring Range	Length	Weight	Box Qty
05074790001 <sup>1)</sup>	179395	7450	1/4"	0,1	0,1-0,34	89	133	1
05074792001 <sup>1)</sup>	179203	7451	1/4"	0,3	0,3-1,0	89	133	1
05074794001 <sup>1)</sup>	179197	7452	1/4"	0,9	0,9-1,5	89	133	1

<sup>1)</sup>The preset torque can be changed. However, this requires the use of special tools and Torque Test Equipment. Please contact the Wera Torque Service.

### 7400 series Kraftform Torque screwdrivers, with factory pre-set value (0.3-3.0 Nm) and Rapidaptor quick-release chuck, handle size 105 mm

Wera torque screwdrivers. With a factory pre-set torque value set to the smallest scale value. For all applications, where the same constant torque and repeat accuracy are required. The torque can be changed with an extra tool within the measuring range (re-calibration kit can be ordered with the code number 05137001001).

Afterwards you can check the set value using an off-the-shelf torque tester. Unlimited loosening torque for slackening stuck screws. Rapidaptor quick-release technology for rapid bit changes.

Suitable for bits with a 1/4" external hexagon drive as per DIN ISO 1173-C 6.3 and E 6.3 (ISO 1173).

Multi-component Kraftform handle with hard and soft zones for high working speeds, whilst being easy on the hand.

Please note: 1 Ncm = 0.01 Nm.

### 7400 series Kraftform Torque screwdrivers, with factory pre-set value (0.3-3.0 Nm) and Rapidaptor quick-release chuck, handle size 105 mm



Code	EAN	Art.No.	Hex Drive	Pre-Set	Measuring Range	Length	Weight	Box Qty
05074715001 <sup>1)</sup>	102911	7460	1/4"	0,3	0,3-1,2	105	155	1
05074716001 <sup>1)</sup>	102928	7461	1/4"	1,2	1,2-3,0	105	155	1

<sup>1)</sup>The preset torque can be changed. However, this requires the use of special tools and Torque Test Equipment. Please contact the Wera Torque Service.



**7400 series Kraftform Torque screwdrivers, with factory pre-set value (3.0-8.8 Nm) and Rapidaptor quick-release chuck, pistol handle**

Wera torque screwdriver. Kraftform pistol handle for particularly high torque transmission, multi-component for high working speeds and particularly ergonomic screwdriving. With a factory pre-set torque value set to the smallest scale value. For all applications, where the same constant torque and repeat accuracy are required. The torque can be changed with an extra tool within the measuring range (re-calibration kit can be ordered with the code number 05137002001).

Afterwards you can check the set value using an off-the-shelf torque tester. Unlimited loosening torque for slackening stuck screws. Rapidaptor quick-release technology for rapid bit changes.

Suitable for bits with a 1/4" external hexagon drive as per DIN ISO 1173-C 6.3 and E 6.3 (ISO 1173).

Multi-component Kraftform handle with hard and soft zones for high working speeds, whilst being easy on the hand.

Suitable for bits with a 1/4" hexagon drive as per DIN ISO 1173-C 6.3 and E 6.3 (ISO 1173).

Please note: 1 Ncm = 0.01 Nm.

**7400 series Kraftform Torque screwdrivers, with factory pre-set value (3.0-8.8 Nm) and Rapidaptor quick-release chuck, pistol handle**

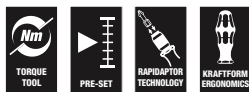

	EAN							
<b>Code</b>	4013288	Art.No.						
05074717001 <sup>1)</sup>	102935	7462	1/4"	3,0	3,0-6,0	150	100	1
05074728001 <sup>1)</sup>	156167	7463	1/4"	4,0	4,0-8,8	150	100	1

<sup>1)</sup>The preset torque can be changed. However, this requires the use of special tools and Torque Test Equipment. Please contact the Wera Torque Service.

**7400 Imperial series Kraftform Torque screwdrivers, with factory pre-set value (2.5-29.0 in. lbs.) and Rapidaptor quick-release chuck, handle size 105 mm**

Wera torque screwdrivers. With a factory pre-set torque value set to the smallest scale value. For all applications, where the same constant torque and repeat accuracy are required.

The torque can be changed with an extra tool within the measuring range (re-calibration kit can be ordered with the code number 05137001001).

Afterwards you can check the set value using an off-the-shelf torque tester. Unlimited loosening torque for slackening stuck screws. Rapidaptor quick-release technology for rapid bit changes.

Suitable for bits with a 1/4" external hexagon drive as per DIN ISO 1173-C 6.3 and E 6.3 (ISO 1173).

Multi-component Kraftform handle with hard and soft zones for high working speeds, whilst being easy on the hand.

Please note: 1 Ncm = 0.01 Nm.

**7400 Imperial series Kraftform Torque screwdrivers, with factory pre-set value (2.5-29.0 in. lbs.) and Rapidaptor quick-release chuck, handle size 105 mm**



	EAN							
<b>Code</b>	4013288	Art.No.						
05074720001 <sup>1)</sup>	102942	7465	1/4"	2,5	2,5-11,5	105	155	1
05074722001 <sup>1)</sup>	103116	7466	1/4"	11,0	11,0-29,0	105	155	1

<sup>1)</sup>The preset torque can be changed. However, this requires the use of special tools and Torque Test Equipment. Please contact the Wera Torque Service.

**7400 Imperial series Kraftform Torque screwdrivers, with factory pre-set value (25.0-55.0 in. lbs.) and Rapidaptor quick-release chuck, pistol handle**

Wera torque screwdriver. Kraftform pistol handle for particularly high torque transmission, multi-component for high working speeds and particularly ergonomic screwdriving. With a factory pre-set torque value set to the smallest scale value. <sup>1</sup>

For all applications, where the same constant torque and repeat accuracy are required. The torque can be changed with an extra tool within the measuring range (re-calibration kit can be ordered with the code number 05137002001).

Afterwards you can check the set value using an off-the-shelf torque tester.

Unlimited loosening torque for slackening stuck screws. Rapidaptor quick-release technology for rapid bit changes.

Suitable for bits with a 1/4" external hexagon drive as per DIN ISO 1173-C 6.3 and E 6.3 (ISO 1173).

Multi-component Kraftform handle with hard and soft zones for high working speeds, whilst being easy on the hand.

Please note: 1 Ncm = 0.01 Nm.

**7400 Imperial series Kraftform Torque screwdrivers, with factory pre-set value (25.0-55.0 in. lbs.) and Rapidaptor quick-release chuck, pistol handle**

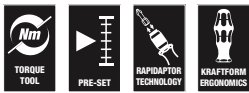

	EAN							
Code	4013288	Art.No.		in. lbs.	in. lbs.	mm	mm	
05074721001 <sup>1)</sup>	102959	7467	1/4"	25,0	25,0-55,0	150	100	1

<sup>1)</sup>The preset torque can be changed. However, this requires the use of special tools and Torque Test Equipment. Please contact the Wera Torque Service.

**7400 ESD series Kraftform Torque screwdrivers, with factory pre-set value (0.1-1.5 Nm) and Rapidaptor quick-release chuck, handle size 105 mm**

Wera torque screwdriver. Safe protection against electrostatic charge and associated damage. With a factory pre-set torque value set to the smallest scale value.

For all applications, where the same constant torque and repeat accuracy are required. The torque can be changed with an extra tool within the measuring range (re-calibration kit can be ordered with the code number 05137003001).

Afterwards you can check the set value using an off-the-shelf torque tester. Unlimited loosening torque for slackening stuck screws. Rapidaptor quick-release technology for rapid bit changes.

Suitable for bits with a 1/4" hexagon drive as per DIN ISO 1173-C 6.3 and E 6.3 (ISO 1173).

Multi-component Kraftform handle with hard and soft zones for high working speeds, whilst being easy on the hand.

Please note: 1 Ncm = 0.01 Nm.

- ESD-safe tool thanks to surface resistance of  $\leq 10^9$  Ohm

**7400 ESD series Kraftform Torque screwdrivers, with factory pre-set value (0.1-1.5 Nm) and Rapidaptor quick-release chuck, handle size 105 mm**

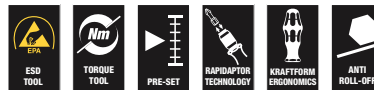

	EAN							
Code	4013288	Art.No.		Nm	Nm	mm	mm	
05074840001 <sup>1)</sup>	179487	7460 ESD	1/4"	0,3	0,3-1,2	105	155	1
05074842001 <sup>1)</sup>	179098	7461 ESD	1/4"	1,2	1,2-3,0	105	155	1

<sup>1)</sup>The preset torque can be changed. However, this requires the use of special tools and Torque Test Equipment. Please contact the Wera Torque Service.



**7400 ESD series Kraftform Torque screwdrivers, with factory pre-set value (0.1-1.5 Nm) and Rapidaptor quick-release chuck, handle size 89 mm**

Wera torque screwdriver. Safe protection against electrostatic charge and associated damage. With a factory pre-set torque value set to the smallest scale value. For all applications, where the same constant torque and repeat accuracy are required.

The torque can be changed with an extra tool within the measuring range (re-calibration kit can be ordered with the code number 05137003001).

Afterwards you can check the set value using an off-the-shelf torque tester. Rapidaptor quick-release technology for rapid bit changes. Unlimited loosening torque for slackening stuck screws.

Multi-component Kraftform handle with hard and soft zones for high working speeds, whilst being easy on the hand.

Suitable for bits with a 1/4" hexagon drive as per DIN ISO 1173-C 6.3 and E 6.3 (ISO 1173).

Please note: 1 Ncm = 0.01 Nm.

- ESD-safe tool thanks to surface resistance of  $\leq 10^9$  Ohm

**7400 ESD series Kraftform Torque screwdrivers, with factory pre-set value (0.1-1.5 Nm) and Rapidaptor quick-release chuck, handle size 89 mm**

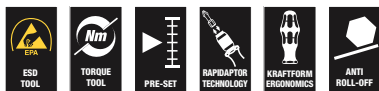

Code	EAN	Art.No.	Drive	Pre-set Nm	Measuring range Nm	Handle length mm	Bit length mm	Quantity
05074820001 <sup>1)</sup>	179210	7450 ESD	1/4"	0,1	0,1-0,34	89	133	1
05074822001 <sup>1)</sup>	179470	7451 ESD	1/4"	0,3	0,3-1,0	89	133	1
05074824001 <sup>1)</sup>	179227	7452 ESD	1/4"	0,9	0,9-1,5	89	133	1

<sup>1)</sup>The preset torque can be changed. However, this requires the use of special tools and Torque Test Equipment. Please contact the Wera Torque Service.

**7400 ESD series Kraftform Torque screwdrivers, with factory pre-set value (0.1-1.0 Nm) and quick-release chuck**

Wera torque screwdriver. Safe protection against electrostatic charge and associated damage. With a factory pre-set torque value set to the smallest scale value.

For all applications, where the same constant torque and repeat accuracy are required. The torque can be changed with an extra tool within the measuring range (re-calibration kit can be ordered with the code number 05137003001).

Afterwards you can check the set value using an off-the-shelf torque tester. With quick-release chuck for rapid bit change. Unlimited loosening torque for slackening stuck screws.

Multi-component Kraftform handle with hard and soft zones for high working speeds, whilst being easy on the hand.

Suitable for bits with a 4 mm Halfmoon drive (Wera series 9) and a 4 mm HIOS drive (Wera series 21).

Please note: 1 Ncm = 0.01 Nm.

- ESD-safe tool thanks to surface resistance of  $\leq 10^9$  Ohm
- Suitable for bits with 4 mm halfmoon and 4 mm HIOS drive

**7400 ESD series Kraftform Torque screwdrivers, with factory pre-set value (0.1-1.0 Nm) and quick-release chuck**



Code	EAN	Art.No.	Pre-set Nm	Measuring range Nm	Handle length mm	Bit length mm	Quantity
05074826001 <sup>1)</sup>	179067	7455 ESD	0,1	0,1-0,34	89	138	5 1/4" 1
05074828001 <sup>1)</sup>	179050	7456 ESD	0,3	0,3-1,0	89	138	5 1/4" 1

<sup>1)</sup>The preset torque can be changed. However, this requires the use of special tools and Torque Test Equipment. Please contact the Wera Torque Service.



## 1460 ESD Kraftform Micro torque screwdrivers, with factory pre-set value (0.02-0.11 Nm) and quick-release chuck

With a factory pre-set torque value set to the smallest scale value. For all applications, where the same constant torque and repeat accuracy are required. The torque can be changed within the measuring range with the extra tool 05137004001.

Afterwards you can check the set value using an off-the-shelf torque tester.

Compact handle/interchangeable blades system for torque-controlled precision screwdriving. The Kraftform Micro ESD torque screwdriver is ideal for torque-controlled jobs on electrostatically sensitive components. Suitable for bits with a 4 mm Halfmoon drive (Wera series 9) and a 4 mm HIOS drive (Wera series 21). Tamper-proof. Clearly audible and tactile signal when the set torque is reached. Repeatability is 100% guaranteed. Unlimited manual loosening torque.

Electrical surface resistance  $\leq 10^9$  ohms for safe protection against electrostatic charge.

Manufactured as per DIN EN 61340-5-1. Handle/interchangeable blades system for rapid blade changes. Kraftform Micro handle with rotating cap and free-turning zone for rapid turning, making any time-consuming repositioning of the fingers unnecessary.

Power zone with integrated soft zones ensures the transmission of high tightening and loosening torques. Precision zone directly above the blade for the correct rotation angle for adjustment work.

Rapid bit fixing: Simply push the bit into the holder for automatic locking and a secure fit. To change the bit, simply push the sleeve forward and remove the bit. Free-running actuating sleeve for easy handling of the tool during the screwdriving process.

Bits suitable for manual and machine operated screwdriving connections with electric screwdrivers (including HIOS, Delvo, Sehan). Use with e.g. smartphones, mobile phones, cameras, electronic devices, in dental laboratories and dental surgeries.

Please note: 1 Ncm = 0.01 Nm.

- ESD-safe tool thanks to surface resistance of  $\leq 10^9$  Ohm
- Suitable for the take-up of bits with 4 mm halfmoon drive and 4 mm HIOS drive
- Applications e.g. on smartphones, mobile phones, cameras, electronic equipment

## 1460 ESD Kraftform Micro torque screwdrivers, with factory pre-set value (0.02-0.11 Nm) and quick-release chuck



	EAN						
Code	4013288	Art.No.	Nm	Nm	mm		
05074800001 <sup>1)</sup>	168351	1460 ESD	0,035	0,02-0,06	131	5 1/4"	1
05074810001 <sup>1)</sup>	179463	1461 ESD	0,050	0,05-0,11	131	5 1/4"	1

<sup>1)</sup>The preset torque can be changed. However, this requires the use of special tools and Torque Test Equipment. Please contact the Wera Torque Service.

**Series 7400 Kraftform torque screwdrivers with a customised factory pre-set measurement value, handle size 89 mm**

Wera torque screwdriver. With a customised factory pre-set torque value. For all applications, where the same constant torque and repeat accuracy are required.

The torque can be changed with an extra tool within the measuring range (re-calibration kit can be ordered with the code number 05137003001). Afterwards you can check the set value using an off-the-shelf torque tester.

Unlimited loosening torque for slackening stuck screws.  
Rapidaptor quick-release technology for rapid bit changes.

Suitable for bits with a 1/4" external hexagon drive as per DIN ISO 1173-C 6.3 and E 6.3 (ISO 1173).

Multi-component Kraftform handle with hard and soft zones for high working speeds, whilst being easy on the hand.

Please note: 1 Ncm = 0.01 Nm.

**Series 7400 Kraftform torque screwdrivers with a customised factory pre-set measurement value, handle size 89 mm**



Code	EAN	Art.No.						
			Nm	mm	mm			
05074790010	188106	7450	1/4"	0,1-0,34	89	133	5 1/4"	1
05074792010	188113	7451	1/4"	0,3-1,0	89	133	5 1/4"	1
05074794010	188137	7452	1/4"	0,9-1,5	89	133	5 1/4"	1

<sup>\*)</sup>The desired settings can be made in the following units: Nm, kgf. m, lbf. ft., ozf. in., dN. m, kgf. cm, lbf. in, in. oz, cN. m, gf. m, ft. lb, gf. cm, in. lb.

**Series 7400 Kraftform torque screwdrivers with a customised factory pre-set measurement value, handle size 105 mm**

Wera torque screwdriver. With a customised factory pre-set torque value. For all applications, where the same constant torque and repeat accuracy are required.

The torque can be changed with an extra tool within the measuring range (re-calibration kit can be ordered with the code number 05137001001). Afterwards you can check the set value using an off-the-shelf torque tester.

Unlimited loosening torque for slackening stuck screws.  
Rapidaptor quick-release technology for rapid bit changes.

Suitable for bits with a 1/4" external hexagon drive as per DIN ISO 1173-C 6.3 and E 6.3 (ISO 1173).

Multi-component Kraftform handle with hard and soft zones for high working speeds, whilst being easy on the hand.

Please note: 1 Ncm = 0.01 Nm.

- Customized pre-set torque screwdriver with Rapidaptor quick-release chuck
- Only adjustable with an extra tool
- Suitable for bits with 1/4" hex head drive
- Distinct signal when pre-set value is reached
- Multi-component Kraftform handle for high working speeds

**Series 7400 Kraftform torque screwdrivers with a customised factory pre-set measurement value, handle size 105 mm**



Code	EAN	Art.No.						
			Nm	mm	mm			
05074715010	188144	7460	1/4"	0,3-1,2	105	155	6"	1
05074716010	188151	7461	1/4"	1,2-3,0	105	155	6"	1

<sup>\*)</sup>The desired settings can be made in the following units: Nm, kgf. m, lbf. ft., ozf. in., dN. m, kgf. cm, lbf. in, in. oz, cN. m, gf. m, ft. lb, gf. cm, in. lb.

**Series 7400 Krafftform torque screwdrivers with a customised factory pre-set measurement value, pistol handle**

Wera torque screwdriver. Krafftform pistol handle for particularly high torque transmission, multi-component for high working speeds and particularly ergonomic screwdriving.

With a customised factory pre-set torque value. For all applications, where the same constant torque and repeat accuracy are required. The torque can be changed with an extra tool within the measuring range (re-calibration kit can be ordered with the code number 05137002001). Afterwards you can check the set value using an off-the-shelf torque tester.

Rapidaptor quick-release technology for rapid bit changes. Unlimited loosening torque for slackening stuck screws.

Multi-component Krafftform handle with hard and soft zones for high working speeds, whilst being easy on the hand.

Please note: 1 Ncm = 0.01 Nm.

**Series 7400 Imperial Krafftform torque screwdrivers with a customised factory pre-set measurement value, handle size 105 mm**

Wera torque screwdriver. With a customised factory pre-set torque value.

For all applications, where the same constant torque and repeat accuracy are required.

The torque can be changed with an extra tool within the measuring range (re-calibration kit can be ordered with the code number 05137001001). Afterwards you can check the set value using an off-the-shelf torque tester.

Unlimited loosening torque for slackening stuck screws. Rapidaptor quick-release technology for rapid bit changes.

Suitable for bits with a 1/4" external hexagon drive as per DIN ISO 1173-C 6.3 and E 6.3 (ISO 1173).

Multi-component Krafftform handle with hard and soft zones for high working speeds, whilst being easy on the hand.

Please note: 1 Ncm = 0.01 Nm.

**Series 7400 Krafftform torque screwdrivers with a customised factory pre-set measurement value, pistol handle**



	EAN							
Code	4013288	Art.No.		Nm	mm	mm		
05074717010	188168	7462	1/4"	3,0-6,0	150	100	6"	1
05074728010	188199	7463	1/4"	4,0-8,8	150	100	6"	1

\*The desired settings can be made in the following units: Nm, kgf. m, lbf. ft., ozf. in., dN. m, kgf. cm, lbf. in, in. oz, cN. m, gf. m, ft. lb, gf. cm, in. lb.

**Series 7400 Imperial Krafftform torque screwdrivers with a customised factory pre-set measurement value, handle size 105 mm**



	EAN							
Code	4013288	Art.No.		in. lbs.	mm	mm		
05074720010	188250	7465	1/4"	2,5-11,5	105	155	6"	1
05074722010	188267	7466	1/4"	11,0-29,0	105	155	6"	1

\*The desired settings can be made in the following units: Nm, kgf. m, lbf. ft., ozf. in., dN. m, kgf. cm, lbf. in, in. oz, cN. m, gf. m, ft. lb, gf. cm, in. lb.

**Series 7400 Imperial Kraftform torque screwdrivers with a customised factory pre-set measurement value, pistol handle**

Wera torque screwdriver. Kraftform pistol handle for particularly high torque transmission, multi-component for high working speeds and particularly ergonomic screwdriving.

With a customised factory pre-set torque value. For all applications, where the same constant torque and repeat accuracy are required.

The torque can be changed with an extra tool within the measuring range (re-calibration kit can be ordered with the code number 05137002001). Afterwards you can check the set value using an off-the-shelf torque tester.

Rapidaptor quick-release technology for rapid bit changes. Unlimited loosening torque for slackening stuck screws.

Multi-component Kraftform handle with hard and soft zones for high working speeds, whilst being easy on the hand.

Please note: 1 Ncm = 0.01 Nm.

**Series 7400 Imperial Kraftform torque screwdrivers with a customised factory pre-set measurement value, pistol handle**

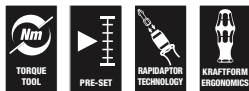

	EAN							
Code	4013288	Art.No.	in. lbs.	mm	mm	mm	mm	
05074721010	188274	7467	1/4"	25,0-55,0	150	100	6"	1

\*\*The desired settings can be made in the following units: Nm, kgf. m, lbf. ft., ozf. in., dN. m, kgf. cm, lbf. in, in. oz, cN. m, gf. m, ft. lb, gf. cm, in. lb.

**1460 ESD Kraftform Micro torque screwdrivers with a customised factory pre-set measurement value with quick-release chuck**

With a customised factory pre-set torque value. The torque can be changed with an extra tool within the measuring range (re-calibration kit can be ordered with the code number 05137004001).

Afterwards you can check the set value using an off-the-shelf torque tester. Compact handle/interchangeable blades system for torque-controlled precision screwdriving.

The Kraftform Micro ESD torque screwdriver is ideal for torque-controlled jobs on electrostatically sensitive components. Suitable for bits with a 4 mm Halfmoon drive (Wera series 9) and a 4 mm HIOS drive (Wera series 21).

Tamper-proof. Clearly audible and tactile signal when the set torque is reached. Repeatability is 100% guaranteed. Unlimited manual loosening torque.

Electrical surface resistance  $\leq 10^9$  ohms for safe protection against electrostatic charge.

Manufactured as per DIN EN 61340-5-1. Handle/interchangeable blades system for rapid blade changes.

Kraftform Micro handle with rotating cap and free-turning zone for rapid turning, making any time-consuming repositioning of the fingers unnecessary.

Power zone with integrated soft zones ensures the transmission of high tightening and loosening torques. Precision zone directly above the blade for the correct rotation angle for adjustment work. Rapid bit fixing: Simply push the bit into the holder for automatic locking and a secure fit.

To change the bit, simply push the sleeve forward and remove the bit. Free-running actuating sleeve for easy handling of the tool during the screwdriving process.

Bits suitable for manual and machine operated screwdriving connections with electric screwdrivers (including HIOS, Delvo, Sehan).

Use with e.g. smartphones, mobile phones, cameras, electronic devices, in dental laboratories and dental surgeries.

Please note: 1 Ncm = 0.01 Nm.

- ESD-safe tool thanks to surface resistance of  $\leq 10^9$  Ohm
- Suitable for the take-up of bits with 4 mm halfmoon drive and 4 mm HIOS drive
- Applications e.g. on smartphones, mobile phones, cameras, electronic equipment

**1460 ESD Kraftform Micro torque screwdrivers with a customised factory pre-set measurement value with quick-release chuck**

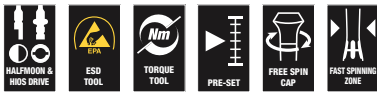

	EAN						
Code	4013288	Art.No.	Nm	mm			
05074800010	188304	1460 ESD	0,02-0,06	131	5 1/4"		1
05074810010	188311	1461 ESD	0,05-0,11	131	5 1/4"		1

<sup>\*)</sup>The desired settings can be made in the following units: Nm, kgf. m, lbf. ft., ozf. in., dN. m, kgf. cm, lbf. in, in. oz, cN. m, gf. m, ft. lb, gf. cm, in. lb.

**Series 7400 ESD Kraftform torque screwdrivers with a customised factory pre-set measurement value, handle size 105 mm**

Wera torque screwdriver. Safe protection against electrostatic charge and associated damage. With a customised factory pre-set torque value.

For all applications, where the same constant torque and repeat accuracy are required.

The torque can be changed with an extra tool within the measuring range (re-calibration kit can be ordered with the code number 05137001001). Afterwards you can check the set value using an off-the-shelf torque tester.

Rapidaptor quick-release technology for rapid bit changes. Unlimited loosening torque for slackening stuck screws.

Multi-component Kraftform handle with hard and soft zones for high working speeds, whilst being easy on the hand.

Suitable for bits with a 1/4" external hexagon drive as per DIN ISO 1173-C 6.3 and E 6.3 (ISO 1173).

Please note: 1 Ncm = 0.01 Nm.

- ESD-safe tool thanks to surface resistance of  $\leq 10^9$  Ohm

**Series 7400 ESD Kraftform torque screwdrivers with a customised factory pre-set measurement value, handle size 105 mm**

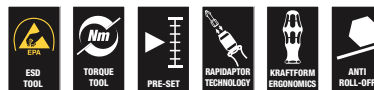

	EAN							
Code	4013288	Art.No.	Nm	mm	mm			
05074840010	188236	7460 ESD	1/4"	0,3-1,2	105	133	6"	1
05074842010	188243	7461 ESD	1/4"	1,2-3,0	105	155	6"	1

<sup>\*)</sup>The desired settings can be made in the following units: Nm, kgf. m, lbf. ft., ozf. in., dN. m, kgf. cm, lbf. in, in. oz, cN. m, gf. m, ft. lb, gf. cm, in. lb.



**Series 7400 ESD Krafftform torque screwdrivers with a customised factory pre-set measurement value, handle size 89 mm**

Wera torque screwdriver. Safe protection against electrostatic charge and associated damage.

With a customised factory pre-set torque value.

For all applications, where the same constant torque and repeat accuracy are required.

The torque can be changed with an extra tool within the measuring range (re-calibration kit can be ordered with the code number 05137003001). Afterwards you can check the set value using an off-the-shelf torque tester.

Unlimited loosening torque for slackening stuck screws.  
Rapidaptor quick-release technology for rapid bit changes.

Suitable for bits with a 1/4" external hexagon drive as per DIN ISO 1173-C 6.3 and E 6.3 (ISO 1173).

Multi-component Krafftform handle with hard and soft zones for high working speeds, whilst being easy on the hand.

Please note: 1 Ncm = 0.01 Nm.

- ESD-safe tool thanks to surface resistance of  $\leq 10^9$  Ohm

**Series 7400 ESD Krafftform torque screwdrivers with a customised factory pre-set measurement value, handle size 89 mm**

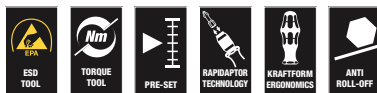

	EAN							
Code	4013288	Art.No.	Nm	mm	mm			
05074820010	188205	7450 ESD	1/4"	0,1-0,34	89	133	5 1/4"	1
05074822010	188212	7451 ESD	1/4"	0,3-1,0	89	133	5 1/4"	1
05074824010	188229	7452 ESD	1/4"	0,9-1,5	89	133	5 1/4"	1

<sup>\*)</sup>The desired settings can be made in the following units: Nm, kgf. m, lbf. ft., ozf. in., dN. m, kgf. cm, lbf. in, in. oz, cN. m, gf. m, ft. lb, gf. cm, in. lb.

**Series 7400 ESD Krafftform torque screwdrivers with a customised factory pre-set measurement value, with quick-release chuck**

Wera torque screwdriver. Safe protection against electrostatic charge and associated damage. With a customised factory pre-set torque value.

For all applications, where the same constant torque and repeat accuracy are required.

The torque can be changed within the measuring range with the extra tool 05137003001. Afterwards you can check the set value using an off-the-shelf torque tester.

Rapidaptor quick-release technology for rapid bit changes.  
Unlimited loosening torque for slackening stuck screws.

Multi-component Krafftform handle with hard and soft zones for high working speeds, whilst being easy on the hand.

Suitable for bits with a 4 mm Halfmoon drive (Wera series 9) and a 4 mm HIOS drive (Wera series 21).

Please note: 1 Ncm = 0.01 Nm.

- ESD-safe tool thanks to surface resistance of  $\leq 10^9$  Ohm
- Suitable for bits with 4 mm halfmoon and 4 mm HIOS drive

**Series 7400 ESD Krafftform torque screwdrivers with a customised factory pre-set measurement value, with quick-release chuck**



	EAN						
Code	4013288	Art.No.	Nm	mm	mm		
05074826010	188281	7455 ESD	0,1-0,34	89	138	5 1/4"	1
05074828010	188298	7456 ESD	0,3-1,0	89	138	5 1/4"	1

<sup>\*)</sup>The desired settings can be made in the following units: Nm, kgf. m, lbf. ft., ozf. in., dN. m, kgf. cm, lbf. in, in. oz, cN. m, gf. m, ft. lb, gf. cm, in. lb.

### 7510 Kraftform Safe-Torque Speed Torque screwdriver, 1-3 Nm

- Torque screwdriver with quick torque adjustment
- Easy and quick torque setting
- Fixed position (Torque Lock) for unlimited tightening and loosening moments
- Secure slip-over torque function for clockwise/anti-clockwise torque-control
- Quick and easy setting of the selectable tightening torques (1.0; 1.5; 2.0; 2.5; 3.0 Nm)
- For bits with 1/4" external hexagon drive, also suitable for socket wrench inserts via adapter

### 7510 Kraftform Safe-Torque Speed Torque screwdriver, 1-3 Nm



Code	EAN	Hexagon Drive	1,0 Nm	1,5 Nm	2,0 Nm	2,5 Nm	3,0 Nm	1
05075810001	230669	1/4"						

### 7510/14 Safe-Torque Speed Tool set for carbide inserts

14-piece tool set. For professional screwdriving/professional fine adjustment AND for torque-controlled screwdriving.

Secure slip-over torque mechanism with quick clockwise/counterclockwise setting and five selectable tightening torques (1.0; 1.5; 2.0; 2.5; 3.0 Nm) and one fixed position (Torque Lock) for unlimited loosening and tightening moments.

Quick-release holder for high robustness; suitable for bits with 1/4" external hexagon drive. 14 tough bits (25 mm length) for TORX PLUS®, TORX® and hexagonal socket screws.

The tool set is particularly suitable for bolting carbide inserts. The Safe-Torque Speed 7510 torque wrench with its five selectable torque values recommended by leading carbide tool manufacturers ensures a reliable torque-controlled screw connection of replaceable carbide inserts.

- Particularly suitable for bolting carbide inserts
- Quick and easy setting of the selectable tightening torques (1.0; 1.5; 2.0; 2.5; 3.0 Nm)
- Suitable for docking with the Wera 2go system

### 7510/14 Safe-Torque Speed Tool set for carbide inserts



Code	EAN	1
05075840001	230683	1
		<b>7510</b> 1x 1/4"x1,0 Nm/1,5 Nm/2,0 Nm/ 2,5 Nm/3,0 Nm x 147,5
		<b>867/1 IP TORX PLUS®</b> 1x 7 IPx25; 1x 8 IPx25; 1x 9 IPx25; 1x 10 IPx25; 1x 15 IPx25
		<b>867/1 TORX®</b> 1x TX 7x25; 1x TX 8x25; 1x TX 9x25; 1x TX 10x25; 1x TX 15x25
		<b>840/1 Z</b> 1x 2,0x25; 1x 2,5x25; 1x 3,0x25

### 7515 Kraftform Safe-Torque Speed Torque screwdriver, 2-6 Nm

- Torque screwdriver with quick torque adjustment
- Easy and quick torque setting
- Fixed position (Torque Lock) for unlimited tightening and loosening moments
- Secure slip-over torque function for clockwise/anti-clockwise torque-control
- Quick and easy setting of the selectable tightening torques (2.0; 3.0; 4.0; 5.0; 6.0 Nm)
- For bits with 1/4" external hexagon drive, also suitable for socket wrench inserts via adapter
- For bits with 1/4" external hexagon drive, also suitable for socket wrench inserts via adapter

### 7515 Kraftform Safe-Torque Speed Torque screwdriver, 2-6 Nm

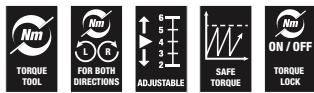

	EAN								
Code	4013288		Nm	Nm	Nm	Nm	Nm	Nm	
05075815001	228314	1/4"	2,0	3,0	4,0	5,0	6,0		1

### 7515/16 Kraftform Safe-Torque Speed Universal 1

16-piece tool set. For professional screwdriving/professional fine adjustment AND for torque-controlled screwdriving. Secure slip-over torque mechanism with quick clockwise/counterclockwise setting and five selectable tightening torques (2.0; 3.0; 4.0; 5.0; 6.0 Nm) and one fixed position (Torque Lock) for unlimited loosening and tightening moments.

Quick-release holder for high robustness. Suitable for bits with 1/4" external hexagon drive. 15 tough bits (89 mm length).

- Torque screwdriver with quick torque adjustment
- Quick and easy setting of the selectable tightening torques (2.0; 3.0; 4.0; 5.0; 6.0 Nm)
- Suitable for docking with the Wera 2go system

### 7515/16 Kraftform Safe-Torque Speed Universal 1



	Code	EAN		
	05075851001	4013288 228338		1
			<b>7515</b> 1x 1/4"x2,0 Nm/3,0 Nm/4,0 Nm/ 5,0 Nm/6,0 Nm x147,5	
			<b>851/4 Z</b> 1x PH 2x89	
			<b>867/4 Z TORX® B0</b> 1x TX 10x89; 1x TX 15x89; 1x TX 20x89; 1x TX 25x89; 1x TX 30x89	
			<b>867/4 IP TORX PLUS®</b> 1x 10 IPx89; 1x 15 IPx89; 1x 20 IPx89; 1x 25 IPx89; 1x 30 IPx89	
			<b>840/4 Z</b> 1x 3,0x89; 1x 4,0x89; 1x 5,0x89; 1x 6,0x89 <sup>1)</sup>	

<sup>1)</sup>Hexagonal blade



## 7515/7 Kraftform Safe-Torque Speed Bicycle 1

7-piece tool set. For professional screwdriving/professional fine adjustment AND for torque-controlled screwdriving. Secure slip-over torque mechanism with quick clockwise/counterclockwise setting and five selectable tightening torques (2.0; 3.0; 4.0; 5.0; 6.0 Nm) and one fixed position (Torque Lock) for unlimited loosening and tightening moments. Quick-release holder for high robustness. Ideal for bike operations. Suitable for bits with 1/4" external hexagon drive.

6 tough bits (50 mm length), profile and size of the bits are easily recognized thanks to the Wera Take it easy Tool finder with its colour codes and labels.

- Bicycle tool set
- Torque screwdriver with quick torque adjustment
- Quick and easy setting of the selectable tightening torques (2.0; 3.0; 4.0; 5.0; 6.0 Nm)
- Take it easy tool finder: colour coding according to profile and size
- Suitable for docking with the Wera 2go system

## 7515/7 Kraftform Safe-Torque Speed Bicycle 1



Code	EAN		
05075850001	228321		1
		7515 1x 1/4"x2,0 Nm/3,0 Nm/4,0 Nm/ 5,0 Nm/6,0 Nm x147,5	
		867/4 TORX® BTZ 1x TX 10x50; 1x TX 25x50	
		840/4 BTZ 1x 2,5x50; 1x 3,0x50; 1x 4,0x50; 1x 5,0x50	

## 300 Hex Torque-indicator

Wera torque screwdriver with fixed torque for hexagon socket screws. Tamperproof and with a slim hex blade. Unlimited torque for loosening seized screws.

Multi-component Kraftform handle for pleasant, ergonomic working that prevents blisters and calluses. Hard gripping zones for high working speeds whereas soft zones ensure high torque transfer.

Comes with Hex-Plus profile which avoids any rounding of the screw head. The Black Point tip offers high corrosion protection and an exact fit.

## 300 Hex Torque-indicator



	EAN							
Code	4013288	Nm	ft. lb.	mm	mm	mm		
05027910001	096425	2,0	1,4	1,0	4	3,5	65	1
05027911001	096432	2,5	2,0	1,5	4	3,8	65	1
05027912001	096449	3,0	3,0	2,2	4	3,8	65	1

## 300 Hex Torque-indicator, pistol handle

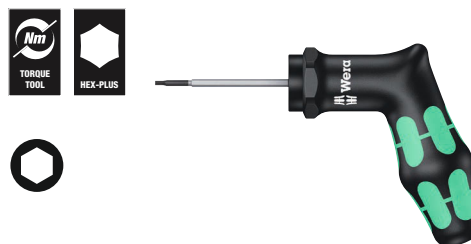

	EAN							
Code	4013288	Nm	ft. lb.	mm	mm	mm		
05027913001	099150	4,0	5,0	3,7	160	100	65	1

## 300 TX TORX® Torque-indicator

- For recessed TORX® screws

## 300 TX TORX® Torque-indicator



	EAN							
Code	4013288	Nm	ft. lb.	mm	mm	mm		
05027930001	093325	TX 6	0,6	0,4	4	3,5	65	1
05027931001	093332	TX 7	0,9	0,7	4	3,5	65	1
05027932001	093349	TX 8	1,2	0,9	4	3,5	65	1
05027933001	093356	TX 9	1,4	1,0	4	3,5	65	1
05027934001	093370	TX 10	2,0	1,5	4	3,8	65	1
05027935001	093363	TX 15	3,0	2,2	4	3,8	65	1

### 300 TX TORX® Torque-indicator, pistol handle



	EAN							
Code	4013288		Nm	ft.lb.	mm	mm	mm	
05027936001	099143	TX 20	5,0	3,7	160	100	65	1

### 300 IP TORX PLUS® Torque-indicator

- For TORX PLUS® screws

### 300 IP TORX PLUS® Torque-indicator



	EAN							
Code	4013288		Nm	ft. lb.	mm	mm	mm	
05028040001	093387	6 IP	0,6	0,4	4	3,5	65	1
05028041001	093394	7 IP	0,9	0,7	4	3,5	65	1
05028042001	093431	8 IP	1,2	0,9	4	3,5	65	1
05028043001	093400	9 IP	1,4	1,0	4	3,5	65	1
05028044001	093417	10 IP	2,0	1,5	4	3,8	65	1
05028045001	093424	15 IP	3,0	2,2	4	3,8	65	1

### 300 IP TORX PLUS® Torque-indicator, pistol handle



	EAN							
Code	4013288		Nm	ft.lb.	mm	mm	mm	
05028046001	099136	20 IP	5,0	3,7	160	100	65	1

### 400 Hex Torque-indicator

Wera torque indicator with fixed torque for hexagon sockets. Tamper proof. The robust slip clutch guarantees a clearly audible and tactile trigger signal when the set torque value is reached, and it is therefore impossible to apply any further torque.

The loosening torque is significantly higher than the set tightening torque, therefore no additional tools are needed for loosening screw connections. The shape of the handle fills the whole hand well and the fingers lie in the softly rounded recessed grips. This ensures optimal, ergonomic power transmission.

### 400 Hex Torque-indicator



	EAN						
Code	4013288		Nm	mm	mm	mm	
05005080001	208835	4,0	4,0	60	48	100	2 3/8" 1
05005081001	208842	5,0	5,0	60	48	100	2 3/8" 1

### 400 TX Torque-indicator

- For recessed TORX® screws

### 400 TX Torque-indicator



	EAN						
Code	4013288		Nm	mm	mm	mm	
05005090001	208811	TX 20	4,0	60	48	100	2 3/8" 1
05005091001	208828	TX 25	5,0	60	48	100	2 3/8" 1

### Safe-Torque A 1 torque wrench with 1/4" square head drive, 2-12 Nm

Torque wrench with slide-over mechanism. Once the set torque has been reached, the tool cannot be overtightened, so that excessive torque cannot be applied. Setting range of 2 to 12 Nm for controlled clockwise and counterclockwise torque operation.

Easy setting and saving of the default value: The audible and tactile clicks on reaching the scale values facilitate the safe setting of the desired torque value. With Torque Lock function for use as a standard ratchet without torque function.

Max. breaking torque of the 1/4" square head as per DIN 3122. The return angle of only 5° allows the ratchet to be used even in confined spaces and therefore also for applications with angles of rotation.

- Slip-over release mechanism - the set torque can never be overtightened
- Torque Lock function: The torque function can be deactivated and the tool can then be used as a standard ratchet with high loosening moments and for applications with defined angles of rotation
- For controlled clockwise and counterclockwise torque operation – tightening and loosening with or without torque
- Easy setting and saving of the desired torque value with audible and tactile clicks when reaching the scale values
- Comfortable working thanks to a small release angle of only 30°
- 1/4" square head drive with socket locking

### Safe-Torque A 1 torque wrench with 1/4" square head drive, 2-12 Nm



	EAN																
Code	4013288		Nm	Nm	lbf. ft.	mm	mm	mm	mm	mm							
0507580001	223012	1/4"	2-12	0,10	2-9	244	94	38,5	31,6	23,7	9 39/64"	3 45/64"	1 33/64"	1 15/64"	15/16"		1

### Safe-Torque A 2 torque wrench with 1/4" hexagon drive, 2-12 Nm

- 1/4" hexagon drive for the use of 1/4" bits

### Safe-Torque A 2 torque wrench with 1/4" hexagon drive, 2-12 Nm



	EAN																
Code	4013288		Nm	Nm	lbf. ft.	mm	mm	mm	mm	mm							
05075801001	223036	1/4"	2-12	0,10	2-9	244	94	38,5	31,6	23,7	9 39/64"	3 45/64"	1 33/64"	1 15/64"	15/16"		1



**Safe-Torque A 1 Set 1, 1/4" square head drive, 2-12 Nm**  
 10-piece 1/4" torque wrench set in a robust textile box; torque wrench with slide-over mechanism. Once the set torque has been reached, the tool cannot be overtightened, so that excessive torque cannot be applied.

Setting range of 2 to 12 Nm for controlled clockwise and counterclockwise torque operation. Easy setting and saving of the default value: The audible and tactile clicks on reaching the scale values facilitate the safe setting of the desired torque value.

The Torque Lock function allows use as a standard ratchet without torque function. Thus also usable for applications with angles of rotation. Max. breaking torque of the 1/4" square head as per DIN 3122. The return angle of only 5° allows the ratchet to be used even in confined spaces.

Included are: Safe-Torque A 1 torque wrench, 1/4" square head, 2-12 Nm, 8 sockets with 1/4" drive and one short extension.

- 1/4" square head drive with socket locking

**Safe-Torque A 1 Imperial Set 1, 1/4" square head drive, 2-12 Nm**

10-piece 1/4" torque wrench set in a robust textile box; torque wrench with slide-over mechanism. Once the set torque has been reached, the tool cannot be overtightened, so that excessive torque cannot be applied.

Setting range of 2 to 12 Nm for controlled clockwise and counterclockwise torque operation. Easy setting and saving of the default value: The audible and tactile clicks on reaching the scale values facilitate the safe setting of the desired torque value.

The Torque Lock function allows use as a standard ratchet without torque function. Thus also usable for applications with angles of rotation. Max. breaking torque of the 1/4" square head as per DIN 3122. The return angle of only 5° allows the ratchet to be used even in confined spaces.

Included are: Safe-Torque A 1 torque wrench, 1/4" square head, 2-12 Nm, 8 sockets with 1/4" drive and one short extension.

- 1/4" square head drive with socket locking

**Safe-Torque A 1 Set 1, 1/4" square head drive, 2-12 Nm**



Code	EAN		
05075830001	4013288 223005		1
		<input type="checkbox"/> Safe-Torque A 1 1x 1/4", 2-12 Nm	
		<input checked="" type="checkbox"/> 8790 HMA 1x 5,5x23,0; 1x 6,0x23,0; 1x 7,0x23,0; 1x 8,0x23,0; 1x 10,0x23,0; 1x 11,0x23,0; 1x 12,0x23,0; 1x 13,0x23,0	
		<input checked="" type="checkbox"/> 8794 SA 1x 1/4"x75,0	
		<b>Hook and Loop Fastener Strip 240</b> 1x 50,0x240,0	

**Safe-Torque A 1 Imperial Set 1, 1/4" square head drive, 2-12 Nm**



Code	EAN		
05075831001	4013288 223074		1
		<input type="checkbox"/> Safe-Torque A 1 1x 1/4", 2-12 Nm	
		<input checked="" type="checkbox"/> 8790 HMA 1x 3/16"x23,0; 1x 7/32"x23,0; 1x 1/4"x23,0; 1x 9/32"x23,0; 1x 5/16"x23,0; 1x 3/8"x23,0; 1x 7/16"x23,0; 1x 1/2"x23,0	
		<input checked="" type="checkbox"/> 8794 SA 1x 1/4"x75,0	
		<b>Hook and Loop Fastener Strip 240</b> 1x 50,0x240,0	

### Safe-Torque A 1 SHK Set 1, 1/4" square head, 2-12 Nm

20-piece set in a robust textile box, especially for HVAC applications. One Safe-Torque A 1 torque wrench with 1/4" square head drive, 2-12 Nm, with slide-over mechanism. Once the set torque has been reached, the tool cannot be overtightened, so that excessive torque cannot be applied. Setting range of 2 to 12 Nm for controlled clockwise and counterclockwise torque operation. Easy setting and saving of the default value: The audible and tactile clicks on reaching the scale values facilitate the safe setting of the desired torque value.

With Torque Lock function for use as a standard ratchet without torque function and thus also usable for applications with angles of rotation. Max. breaking torque of the 1/4" square head as per DIN 3122. The return angle of only 5° allows the ratchet to be used even in confined spaces.

Included are: Safe-Torque A 1 torque wrench, 1/4" square head, 2-12 Nm, 8 sockets with 1/4" drive, 9 bit sockets (hexagonal socket, TORX®) with 1/4" drive, one short extension.

- For operations in plumbing, heating and air conditioning, especially for installing shower cubicles and for assembly and maintenance of gas boilers and condensing boilers

### Safe-Torque A 1 SHK Set 1, 1/4" square head, 2-12 Nm



Code	EAN			
05136073001	228376			1
		<input type="checkbox"/> <b>Safe-Torque A 1</b> 1x 1/4", 2-12 Nm		
		<input checked="" type="checkbox"/> <b>8790 HMA</b> 1x 5,5x23,0; 1x 6,0x23,0; 1x 7,0x23,0; 1x 8,0x23,0; 1x 10,0x23,0; 1x 11,0x23,0; 1x 12,0x23,0; 1x 13,0x23,0		
		<input checked="" type="checkbox"/> <b>8767 A HF</b> 1x TX 15x28,0; 1x TX 20x28,0; 1x TX 25x28,0; 1x TX 30x28,0		
		<input checked="" type="checkbox"/> <b>8740 A HF</b> 1x 3,0x28,0; 1x 4,0x28,0; 1x 5,0x28,0; 1x 6,0x28,0; 1x 8,0x28,0		
		<b>Belt A 0/9</b> 1x 39,0x238,0		
		<input checked="" type="checkbox"/> <b>8794 SA</b> 1x 1/4"x75,0		
		<b>Hook and Loop Fastener Strip 240</b> 1x 50,0x240,0		

### Safe-Torque A 2 Set 1, 1/4" hexagonal, 2-12 Nm

23-piece set; in surface-friendly, compact and extremely robust textile box. Small size and low weight for better mobility.

1 Safe-Torque A 2 torque wrench with 1/4" hexagonal drive, measuring range 2-12 Nm; for controlled clockwise and counterclockwise torque operation; tightening and loosening with or without torque, disengageable torque function (Torque Lock function); 72 teeth; low return angle of 5°; easy setting and saving of the desired torque value, with audible and tactile locking when the scale values are reached, slip-over release mechanism when the set torque is reached; ergonomic 2-component handle; 9 Zyklop sockets, 12 bits (1/4", 50 mm long), one connector for sockets (1/4" external hexagon to 1/4" external square head).

- 1/4" hexagon drive for the use of 1/4" bits
- Use of 1/4" sockets also possible with the Wera adaptor 870/1

### Safe-Torque A 2 Set 1, 1/4" hexagonal, 2-12 Nm



Code	EAN			
05075832001	223043			1
		<input checked="" type="checkbox"/> <b>Safe-Torque A 2</b> 1x 1/4", 2-12 Nm		
		<input checked="" type="checkbox"/> <b>8790 HMA</b> 1x 5,5x23,0; 1x 6,0x23,0; 1x 7,0x23,0; 1x 8,0x23,0; 1x 9,0x23,0; 1x 10,0x23,0; 1x 11,0x23,0; 1x 12,0x23,0; 1x 13,0x23,0		
		<input checked="" type="checkbox"/> <b>870/1</b> 1x 1/4"x25 <sup>1)</sup>		
		<input checked="" type="checkbox"/> <b>851/4 Z</b> 1x PH 2x50		
		<input checked="" type="checkbox"/> <b>867/4 Z TORX®</b> 1x TX 10x50; 1x TX 15x50; 1x TX 20x50; 1x TX 25x50; 1x TX 27x50; 1x TX 30x50		
		<input checked="" type="checkbox"/> <b>840/4 Z</b> 1x 2,5x50; 1x 3,0x50; 1x 4,0x50; 1x 5,0x50; 1x 6,0x50 <sup>2)</sup>		
		<b>Hook and Loop Fastener Strip 240</b> 1x 50,0x240,0		

<sup>1)</sup>With friction ball; for manual nut spinner sockets

<sup>2)</sup>Hexagonal blade

### Click-Torque A 5 torque wrench with reversible ratchet

Click-Torque wrench in the unmistakable, robust Wera design with high accuracy as per DIN EN ISO 6789-1: 2017-07. Easy setting and saving of the default value.

The audible and tactile clicks on reaching the scale values also facilitate the safe setting of the desired torque value. The robust release mechanism guarantees a clearly audible and tactile release signal when the set torque is reached.

For right-hand use (clockwise torque-control) and with 45-tooth reversible ratchet mechanism.

- With 1/4" square drive, reversible ratchet, 45 teeth
- Measuring range: 2.5-25 Nm; precise to +/- 4% as per DIN EN ISO 6789-1:2017-07

### Click-Torque A 5 torque wrench with reversible ratchet, 2.5-25 Nm

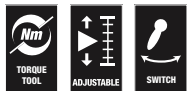

Code	EAN	Drive	Nm	Nm	lbf. ft.	mm	mm	mm	mm	mm	mm	mm	mm	mm	mm	mm	mm	mm	mm	
05075604001	193179	1/4"	2,5-25	0,10	1-18	290	121	42	25	11,5	11 27/64"	4 49/64"	1 21/32"	1"	7/16"					1

### Click-Torque A 6 torque wrench with reversible ratchet, 2.5-25 Nm

- With 1/4" hex drive, reversible ratchet, 45 teeth
- Measuring range: 2.5-25 Nm; Precise to +/- 4% as per DIN EN ISO 6789-1:2017-07

### Click-Torque A 6 torque wrench with reversible ratchet, 2.5-25 Nm



Code	EAN	Drive	Nm	Nm	lbf. ft.	mm	mm	mm	mm	mm	mm	mm	mm	mm	mm	mm	mm	mm	mm	
05075605001	193186	1/4"	2,5-25	0,10	1-18	290	121	42	25	11,5	11 27/64"	4 49/64"	1 21/32"	1"	7/16"					1

## Click-Torque A 6 Set 1

Click torque wrench in the unmistakable Wera design.  
Very robust design with high accuracy as per  
DIN EN ISO 6789-1: 2017-07.

Easy setting and saving of the default value. The audible and tactile clicks on reaching the scale values facilitate the safe setting of the desired torque value.

The robust release mechanism guarantees a clearly audible and tactile release signal when the set torque is reached.

Provides clockwise torque-control and 45-tooth ratchet mechanism. The Wera click torque wrench is accompanied with various accessories in a compact set arrangement.

Included are: Click-Torque A 6 1/4" from 2.5 to 25 Nm, 6 sockets with 1/4" drive, 11 Hex-Plus hexagon bits, Phillips head bits and TORX® bits, plus an extension and socket adaptor.

## Click-Torque A 6 Set 1, 2.5-25 Nm



Code	EAN		
05130110001	4013288 205643		1
		<b>Click-Torque A 6</b> 1x 1/4", 2,5-25 Nm	
		<b>851/4 TZ</b> 1x PH 2x50	
		<b>867/4 Z TORX®</b> 1x TX 15x50; 1x TX 20x50; 1x TX 25x50; 1x TX 27x50; 1x TX 30x50; 1x TX 40x50	
		<b>840/4 Z</b> 1x 3,0x50; 1x 4,0x50; 1x 5,0x50; 1x 6,0x50 <sup>1)</sup>	
		<b>870/1</b> 1x 1/4"x25 <sup>2)</sup>	
		<b>8794 SA</b> 1x 1/4"x75,0	
		<b>8790 HMA</b> 1x 6,0x23,0; 1x 7,0x23,0; 1x 8,0x23,0; 1x 10,0x23,0; 1x 12,0x23,0; 1x 13,0x23,0	
		<b>Hook and Loop Fastener Strip 240</b> 1x 50,0x240,0	

<sup>1)</sup>Hexagonal blade  
<sup>2)</sup>With friction ball; for manual nut spinner sockets

## Bicycle Set Torque 1, 2.5-25 Nm

The 16-piece set from the screwdriving tool specialist Wera solves the most important screwdriving problems associated with bicycles, with reliable control of applied torque to protect sensitive components. With a click-torque wrench in the unmistakable Wera design.

Very robust design with high accuracy as per DIN EN ISO 6789-1: 2017-07. Easy setting and saving of the default values. The audible and tactile snapping on reaching the scale values also facilitates the safe setting of the desired torque values.

The robust release mechanism guarantees a clearly audible and tactile trigger signal when the set torque is reached.

For clockwise torque-control and with a reversible 45-tooth ratchet. The torque wrench is extremely space-saving and supplemented with accessories that are suitable for the torque range and adapted to the most common screwed connections on bicycles; in a robust, surface-friendly textile box.

Included are: Click Torque A 5, 1/4", 2.5 - 25 Nm, 4 sockets with 1/4" drive, 7 Hex Plus hexagon bit sockets and 4 TORX® bit sockets. Sockets and bit sockets with Take it easy tool finder with colour coding by size - for easy and quick location of the required tool.





Bit sockets with holding function for extra comfortable screwdriving without the screw falling off the tool. Incredibly compact arrangement for a lot of tools in a small space.

Textile box with very high robustness and longevity. Additional surface protection through the textile outer material.

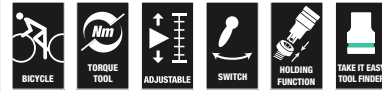
Low weight and volume for easier mobility. Bit sockets with all the benefits of Wera bit technology such as fitting accuracy, wear resistance and concentric run-out properties.

## Bicycle Set Torque 1, 2.5-25 Nm



Code	EAN		
05004180001	4013288 207685		 1
		<b>Click-Torque A 5</b> 1x 1/4", 2,5-25 Nm	
		 <b>8790 HMA</b> 1x 10,0x23,0; 1x 13,0x23,0; 1x 14,0x23,0; 1x 15,0x23,0	
		 <b>8767 A</b> 1x TX 10x28,0; 1x TX 20x28,0; 1x TX 25x28,0; 1x TX 30x28,0	
		 <b>8740 A HF</b> 1x 3,0x28,0; 1x 4,0x28,0; 1x 5,0x28,0; 1x 5,0x100,0; 1x 6,0x28,0; 1x 6,0x100,0; 1x 8,0x28,0	
		<b>Hook and Loop Fastener Strip 240</b> 1x 50,0x240,0	



### Click-Torque B 1 torque wrench with reversible ratchet, 10-50 Nm

- With 3/8" square drive, reversible ratchet, 45 teeth
- Measuring range: 10-50 Nm; Precise to +/- 3% as per DIN EN ISO 6789-1:2017-07
- The Click-Torque collar is placed around the tube of the Wera Click-Torque torque wrench. It prevents the handle from touching the ground. Dirt and damage are avoided

### Click-Torque B 1 torque wrench with reversible ratchet, 10-50 Nm

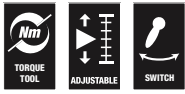

Code	EAN	□																
Code	4013288		Nm	Nm	lbf. ft.	mm	mm	mm	mm	mm								
05075610001	193193	3/8"	10-50	0,25	8-36	360	140	47	35	16,5	14 11/64"	5 33/64"	1 27/32"	1 3/8"	5/8"			1

### Click-Torque B 2 torque wrench with reversible ratchet, 20-100 Nm

- With 3/8" square drive, reversible ratchet, 45 teeth
- Measuring range: 20-100 Nm; precise to +/- 3% as per DIN EN ISO 6789-1:2017-07
- The Click-Torque collar is placed around the tube of the Wera Click-Torque torque wrench. It prevents the handle from touching the ground. Dirt and damage are avoided

### Click-Torque B 2 torque wrench with reversible ratchet, 20-100 Nm

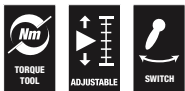

Code	EAN	□																
Code	4013288		Nm	Nm	lbf. ft.	mm	mm	mm	mm	mm								
05075611001	193209	3/8"	20-100	0,5	15-73	405	140	47	43	18,5	15 15/16"	5 33/64"	1 27/32"	1 11/16"	45/64"			1

### Click-Torque C 1 torque wrench with reversible ratchet, 10-50 Nm

- With 1/2" square drive, reversible ratchet, 45 teeth
- Measuring range: 10-50 Nm; Precise to +/- 3% as per DIN EN ISO 6789-1:2017-07
- The Click-Torque collar is placed around the tube of the Wera Click-Torque torque wrench. It prevents the handle from touching the ground. Dirt and damage are avoided

#### Click-Torque C 1 torque wrench with reversible ratchet, 10-50 Nm



Code	EAN	Drive Size	Scale 1	Scale 2	Scale 3	Length 1	Length 2	Length 3	Length 4	Length 5	Length 6	Length 7	Length 8	Length 9	Length 10	Length 11	Length 12	Length 13	Length 14	Length 15	Length 16	Length 17		
05075620001	193216	1/2"	10-50	0,25	8-36	360	140	47	35	16,5	14 11/64"	5 33/64"	1 27/32"	1 3/8"	5/8"									1

### Click-Torque C 2 torque wrench with reversible ratchet, 20-100 Nm

- With 1/2" square drive, reversible ratchet, 45 teeth
- Measuring range: 20-100 Nm; precise to +/- 3% as per DIN EN ISO 6789-1:2017-07
- The Click-Torque collar is placed around the tube of the Wera Click-Torque torque wrench. It prevents the handle from touching the ground. Dirt and damage are avoided

#### Click-Torque C 2 torque wrench with reversible ratchet, 20-100 Nm



Code	EAN	Drive Size	Scale 1	Scale 2	Scale 3	Length 1	Length 2	Length 3	Length 4	Length 5	Length 6	Length 7	Length 8	Length 9	Length 10	Length 11	Length 12	Length 13	Length 14	Length 15	Length 16	Length 17	
05075621001	193223	1/2"	20-100	0,5	15-73	405	140	47	43	18,5	15 15/16"	5 33/64"	1 27/32"	1 11/16"	45/64"								1

**Click-Torque C 3 torque wrench with reversible ratchet, 40-200 Nm**

- With 1/2" square drive, reversible ratchet, 45 teeth
- Measuring range: 40-200 Nm; precise to +/- 3% as per DIN EN ISO 6789-1:2017-07
- The Click-Torque collar is placed around the tube of the Wera Click-Torque torque wrench. It prevents the handle from touching the ground. Dirt and damage are avoided

**Click-Torque C 3 torque wrench with reversible ratchet, 40-200 Nm**

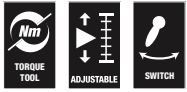

Code	EAN	□	Nm	Nm	lbf. ft.	mm	mm	mm	mm	mm	mm	mm	mm	mm	mm	mm	mm	mm	mm	mm	
05075622001	193230	1/2"	40-200	1,0	30-146	510	140	47	43	18,5	20 5/64"	5 33/64"	1 27/32"	1 11/16"	45/64"						1



### Click-Torque C 3 Set 1, 40-200 Nm

Click torque wrench set in the unmistakable Wera design. Very robust design with high accuracy as per DIN EN ISO 6789-1: 2017-07.

Easy setting and saving of the default values. The audible and tactile snapping on reaching the scale values also facilitates the safe setting of the desired torque values.

The robust release mechanism guarantees a clearly audible and tactile trigger signal when the set torque is reached. For clockwise torque-control and with reversible 45-tooth ratchet.

Torque wrenches and torque-compatible accessories are packed in an extremely space-saving, robust, surface-friendly textile box.

Contains: Click Torque C 3, 1/2", 40-200 Nm, 4 sockets with 1/2" drive, 7 hex plus hexagon socket and TORX® bit sockets plus extension.

#### Click-Torque C 3 Set 1, 40-200 Nm

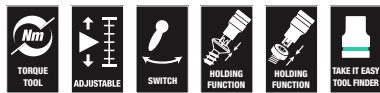

<b>Code</b>	<b>EAN</b>			
05075680001	4013288 207609			1
			<b>Click-Torque C 3</b> 1x 1/2", 40-200 Nm	
			<b>8790 HMC</b> 1x 10,0x37,0; 1x 13,0x37,0; 1x 17,0x37,0; 1x 19,0x37,0	
			<b>8767 C HF</b> 1x TX 30x60,0; 1x TX 40x60,0; 1x TX 45x60,0; 1x TX 50x60,0	
			<b>8740 C HF</b> 1x 6,0x60,0; 1x 8,0x60,0; 1x 10,0x60,0	
			<b>8794 SC</b> 1x 1/2"x125,0	

### Click-Torque C 3 set 2 for cement screwdriving, 40-200 Nm

11-piece set for fitting security-relevant cement screws with defined torque moments as per screw manufacturer instructions.

With Take it easy tool finder with colour coding and size stamping - for easy and fast location of the required tool.

- For fitting security-relevant cement screws with defined torque moments as per screw manufacturer instructions
- 8790 C Impaktor socket wrench inserts for the application with compressed air or electrically driven impact wrenches with 12.5 mm = 1/2" drive (13 mm to 21 mm)
- Click-Torque C 3 torque wrench with reversible ratchet (measuring range: 40-200 Nm; precision ± 3 % as per DIN EN ISO 6789-1:2017-07)
- 11-piece set in premium textile tool box

#### Click-Torque C 3 set 2 for cement screwdriving, 40-200 Nm



<b>Code</b>	<b>EAN</b>			
05075681001	4013288 217561			1
			<b>Click-Torque C 3</b> 1x 1/2", 40-200 Nm	
			<b>8790 C Impaktor</b> 1x 13,0x38,0; 1x 14,0x38,0; 1x 15,0x38,0; 1x 16,0x38,0; 1x 17,0x38,0; 1x 18,0x38,0; 1x 19,0x38,0; 1x 20,0x38,0; 1x 21,0x38,0	
			<b>8894 SC</b> 1x 1/2"x125,0	

### Click-Torque C 4 torque wrench with reversible ratchet, 60-300 Nm

- With 1/2" square drive, reversible ratchet, 45 teeth
- Measuring range: 60-300 Nm; Precise to +/- 3% as per DIN EN ISO 6789-1:2017-07
- The Click-Torque collar is placed around the tube of the Wera Click-Torque torque wrench. It prevents the handle from touching the ground. Dirt and damage are avoided

### Click-Torque C 4 torque wrench with reversible ratchet, 60-300 Nm

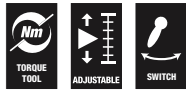

Code	EAN	□				—	—	—	—	—	—	—	—	—	—	—	—	—	—
Code	4013288		Nm	Nm	lbf. ft.	mm	mm	mm	mm	mm	mm	mm	mm	mm	mm	mm	mm	mm	mm
05075623001	193247	1/2"	60-300	1,0	45-220	595	140	47	43	18,5	23 27/64"	5 33/64"	1 27/32"	1 11/16"	45/64"				1

### Click-Torque C 5 torque wrench with reversible ratchet, 80-400 Nm

- With 1/2" square drive, reversible ratchet, 45 teeth
- Measuring range: 80-400 Nm; Precise to +/- 3% as per DIN EN ISO 6789-1:2017-07
- The Click-Torque collar is placed around the tube of the Wera Click-Torque torque wrench. It prevents the handle from touching the ground. Dirt and damage are avoided

### Click-Torque C 5 torque wrench with reversible ratchet, 80-400 Nm

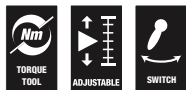

Code	EAN	□				—	—	—	—	—	—	—	—	—	—	—	—	—	—
Code	4013288		Nm	Nm	lbf. ft.	mm	mm	mm	mm	mm	mm	mm	mm	mm	mm	mm	mm	mm	mm
05075624001	193254	1/2"	80-400	1,0	60-295	680	140	47	43	18,5	26 49/64"	5 33/64"	1 27/32"	1 11/16"	45/64"				1

### Click-Torque E 1 torque wrench with reversible ratchet, 200-1000 Nm

- With 3/4" square drive, reversible ratchet, 45 teeth
- Measuring range: 200-1000 Nm; precise to +/- 3% as per DIN EN ISO 6789-1:2017-07
- The Click-Torque collar is placed around the tube of the Wera Click-Torque torque wrench. It prevents the handle from touching the ground. Dirt and damage are avoided

### Click-Torque E 1 torque wrench with reversible ratchet, 200-1000 Nm



Code	EAN	□				—	—	—	—	—	—	—	—	—	—	—	—	—	—
Code	4013288		Nm	Nm	lbf. ft.	mm	mm	mm	mm	mm	mm	mm	mm	mm	mm	mm	mm	mm	mm
05075630001	193261	3/4"	200-1000	1,00	148-737	1250	140	47	63	30	49 7/32"	5 33/64"	1 27/32"	2 31/64"	1 3/16"				1

### Click-Torque Push R/L adjustable torque wrenches for clockwise and anti-clockwise torque-control

Click torque wrench in the unmistakable Wera design. For clockwise and anti-clockwise torque-control. Very robust design with high accuracy as per DIN EN ISO 6789-1: 2017-07. Easy setting and saving of the default value. The audible and tactile clicks on reaching the scale values facilitate the safe setting of the desired torque value. The robust release mechanism guarantees a clearly audible and tactile release signal when the set torque is reached.

With captive  $\frac{3}{4}$ " square head insert to change direction.  $\frac{1}{2}$ " square head drive with socket locking.

- For clockwise and anti-clockwise torque-control thanks to the smooth reversing of the captive square head insert
- Measuring range: 20-100 Nm; precise to +/- 3% as per DIN EN ISO 6789-1:2017-07
- 45 teeth and  $\frac{1}{2}$ " square head drive with socket locking
- Easy setting and saving of the desired torque value with audible and tactile clicks when reaching the scale values
- Audible and tactile release mechanism when the set torque value is reached
- The Click-Torque collar is placed around the tube of the Wera Click-Torque torque wrench. It prevents the handle from touching the ground. Dirt and damage are avoided

#### Click-Torque C 2 Push R/L adjustable torque wrench for clockwise and anti-clockwise torque-control, 20-100 Nm

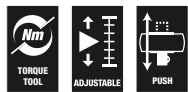

Code	EAN	□	mm	mm	mm	mm	mm	mm	mm	mm	mm	mm	mm	mm	mm	mm	mm	mm	
05075625001	218926	$\frac{1}{2}$ "	20-100	0,5	15-73	405	140	47	43	18,5	15 $\frac{15}{16}$ "	5 $\frac{33}{64}$ "	1 $\frac{27}{32}$ "	1 $\frac{11}{16}$ "	$\frac{45}{64}$ "				1

#### Click-Torque C 3 Push R/L adjustable torque wrench for clockwise and anti-clockwise torque-control, 40-200 Nm

- Measuring range: 40-200 Nm; precise to +/- 3% as per DIN EN ISO 6789-1:2017-07
- For clockwise and anti-clockwise torque-control thanks to the smooth reversing of the captive square head insert
- 45 teeth and  $\frac{1}{2}$ " square head drive with socket locking
- The Click-Torque collar is placed around the tube of the Wera Click-Torque torque wrench. It prevents the handle from touching the ground. Dirt and damage are avoided



Code	EAN	□	mm	mm	mm	mm	mm	mm	mm	mm	mm	mm	mm	mm	mm	mm	mm	mm	
05075626001	218933	$\frac{1}{2}$ "	40-200	1,0	30-146	510	140	47	43	18,5	20 $\frac{5}{64}$ "	5 $\frac{33}{64}$ "	1 $\frac{27}{32}$ "	1 $\frac{11}{16}$ "	$\frac{45}{64}$ "				1

### Click-Torque E 1 Push R/L adjustable torque wrench for clockwise and anti-clockwise torque-control, 200-1000 Nm

- For clockwise and anti-clockwise torque-control thanks to smooth reversing of the captive square head insert
- Measuring range: 200-1000 Nm; precise to +/- 3% as per DIN EN ISO 6789-1:2017-07
- 45 teeth and 3/4" square head drive
- The Click-Torque collar is placed around the tube of the Wera Click-Torque torque wrench. It prevents the handle from touching the ground. Dirt and damage are avoided

### Click-Torque E 1 Push R/L adjustable torque wrench for clockwise and anti-clockwise torque-control, 200-1000 Nm

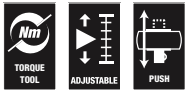

	EAN	□				—	—	—	—	—	—	—	—	—	—	—	—	—
Code	4013288		Nm	Nm	lbf. ft.	mm	mm	mm	mm	mm	mm	mm	mm	mm	mm	mm	mm	mm
05075631001	219053	3/4"	200-1000	1,0	148-737	1250	140	47	63	30	49 7/32"	5 33/64"	1 27/32"	2 31/64"	1 3/16"			1

### Click-Torque X 1 torque wrench for insert tools, 2.5-25 Nm

Click-Torque wrench in the unmistakable, robust Wera design with high accuracy as per DIN EN ISO 6789-1: 2017-07. Easy setting and saving of the default value.

The audible and tactile clicks on reaching the scale values also facilitate the safe setting of the desired torque value. The robust release mechanism guarantees a clearly audible and tactile release signal when the set torque is reached. For right-hand and left-hand use and with 9x12mm insert square for the insertion of insert tools.

- For 9x12 mm interchangeable insert tools
- Measuring range: 2.5-25 Nm; Precise to +/- 4% as per DIN EN ISO 6789-1:2017-07

### Click-Torque X 1 torque wrench for insert tools, 2.5-25 Nm



□	EAN	□				—	S <sub>k</sub>	l <sub>k</sub>	—	—	—	—	—	—	—	—	—	—
Code	4013288		Nm	Nm	lbf. ft.	mm	mm	mm	mm	mm	mm	mm	mm	mm	mm	mm	mm	mm
05075651001	193773	9x12	2,5-25	0,10	1-18	292	17,5	240,0	121	42	24	20	11 9/64"	4 49/64"	1 21/32"	15/16"		1

<sup>1</sup>S<sub>k</sub> = Depth gauge of test attachment to pivot point; l<sub>k</sub> = Length of holding position to torque measurement point

### Click-Torque X 2 torque wrench for insert tools, 10-50 Nm

- For 9x12 mm interchangeable insert tools
- Measuring range: 10-50 Nm; Precise to +/- 3% as per DIN EN ISO 6789-1:2017-07
- The Click-Torque collar is placed around the tube of the Wera Click-Torque torque wrench. It prevents the handle from touching the ground. Dirt and damage are avoided

### Click-Torque X 2 torque wrench for insert tools, 10-50 Nm



□	EAN	□				—	S <sub>k</sub>	l <sub>k</sub>	—	—	—	—	—	—	—	—	—	—
Code	4013288		Nm	Nm	lbf. ft.	mm	mm	mm	mm	mm	mm	mm	mm	mm	mm	mm	mm	mm
05075652001	193797	9x12	10-50	0,25	8-36	338	17,5	285,0	140	47	29	20	13 5/16"	5 33/64"	1 27/32"	1 9/64"		1

<sup>1</sup>S<sub>k</sub> = Depth gauge of test attachment to pivot point; l<sub>k</sub> = Length of holding position to torque measurement point





### Click-Torque X 6 torque wrench for insert tools, 80-400 Nm

- For 14x18 mm interchangeable insert tools
- Measuring range: 80-400 Nm; Precise to +/- 3% as per DIN EN ISO 6789-1:2017-07
- The Click-Torque collar is placed around the tube of the Wera Click-Torque torque wrench. It prevents the handle from touching the ground. Dirt and damage are avoided

### Click-Torque X 6 torque wrench for insert tools, 80-400 Nm



		EAN																
Code	4013288		Nm	Nm	lbf. ft.	mm	S <sub>k</sub>	l <sub>k</sub>	mm	mm	mm	mm	mm	mm	mm	mm	mm	
05075656001	193827	14x18	80-400	1,0	60-295	665	25,5	615,0	140	47	32	26	25 25/32"	5 33/64"	1 27/32"	1 17/64"	1	

\* S<sub>k</sub> = Depth gauge of test attachment to pivot point; l<sub>k</sub> = Length of holding position to torque measurement point

### Click-Torque X 7 torque wrench for insert tools, 10-100 Nm

- For 14x18 mm interchangeable insert tools
- Measuring range: 10-100 Nm; precision ± 4 % as per DIN EN ISO 6789-1:2017-07
- The Click-Torque collar is placed around the tube of the Wera Click-Torque torque wrench. It prevents the handle from touching the ground. Dirt and damage are avoided. Also serves as “anti-roll protection”
- The laser-engraved, abrasion-proof QR code makes it easier to determine the correct torque value depending on the torque wrench and insert tool used

### Click-Torque X 7 torque wrench for insert tools, 10-100 Nm



		EAN																
Code	4013288		Nm	Nm	lbf. ft.	mm	S <sub>k</sub>	l <sub>k</sub>	mm	mm	mm	mm	mm	mm	mm	mm	mm	
05075657001	229335	14x18	10-100	0,5	8-73	395	25,5	343,0	140	47	29	20	14 41/64"	5 33/64"	1 27/32"	1 9/64"	1	

\* S<sub>k</sub> = Actual dimension of the test attachment; l<sub>k</sub> = Distance from the force application point to the test device axis



## 9530 Torque wrench set for heat pumps/air conditioning

4-piece Click-Torque torque wrench set with three self-setting exchangeable Joker insert spanners. For the proper tightening of screw connections when installing and repairing refrigeration and air conditioning systems as well as heat pumps. Click torque wrench in the distinctive Wera design.

Very robust design with high accuracy as per DIN EN ISO 6789-1:2017-07. Easy setting and saving of the default value. The audible and tactile clicks on reaching the scale values facilitate the safe setting of the desired torque value. The robust release mechanism guarantees a clearly audible and tactile release signal when the set torque value is reached. For clockwise and anti-clockwise torque-control and with 14x18 mm square head insert for mounting corresponding insert tools.

With its continuous and parallel jaws, the three self-setting Joker 7880 insert spanners replace several single spanner sizes.

The required size is automatically and continuously set when attaching the tool to the hexagon bolt or screw. The ratchet feature ensures fast and consistent screwdriving without removing the tool. By using the corner-width rectangular prisms, a return angle of only 30° can be achieved.

- Set for the proper tightening of screw connections when installing and repairing refrigeration and air conditioning systems as well as heat pumps
- Click-Torque X 7 torque wrench with mounting for exchangeable insert tools 14x18 mm
- Measuring range: 10-100 Nm; precision  $\pm 4\%$  as per DIN EN ISO 6789-1:2017-07
- The adjustable 7880 Joker covers all metric and imperial dimensions in the respective field of application
- Automatic and continuous gripping of the hexagon screw or bolt
- Fast and consistent screwdriving without removing the wrench thanks to mechanical ratchet function
- The laser-engraved, abrasion-proof QR code makes it easier to determine the correct torque value depending on the torque wrench and insert tool used

## 9530 Torque wrench set for heat pumps/air conditioning



Code	EAN		
05136076001	4013288 228987		1
		<b>Click-Torque X 7</b> 1x 14x18, 10-100 Nm	
		<b>7880 Joker XXL</b> 1x 14x18x24-32x(1 <sup>5</sup> / <sub>16</sub> "-1 1/4")x113,5	
		<b>7880 Joker XL</b> 1x 14x18x19-24x(3/4"-1 <sup>5</sup> / <sub>16</sub> ")x95,0	
		<b>7880 Joker L</b> 1x 14x18x16-19x(5/8"-3/4")x85,5	

### Click-Torque XP 1 pre-set adjustable torque wrench for insert tools, 2.5-25 Nm, 2.5 Nm

Torque wrench with pre-set torque value for all applications where the same torque and repeat accuracy is required. The torque value can be changed within the metered range.

The robust release mechanism guarantees a clearly audible and tactile trigger signal when the set torque value is reached. Square socket for interchangeable plug-in tools for clockwise and anti-clockwise torque-control. A presetting which deviates from this value to a desired torque value within the specified metered range is possible on request.

- With square socket (9x12 mm) for interchangeable plug-in tools; clockwise and anti-clockwise torque-control
- Pre-set click torque wrench in unmistakable Wera design
- Measuring range: 2.5-25 Nm; Precise to +/- 2% as per DIN EN ISO 6789-1:2017-07
- Pre-set torque values can be changed within the metered range in the test laboratory

### Click-Torque XP 1 pre-set adjustable torque wrench for insert tools, 2.5-25 Nm, 2.5 Nm



		EAN					$S_k$	$l_k$										
Code			Nm	Nm	lbf. ft.	mm	mm	mm	mm	mm	mm	mm	mm	mm	mm	mm	mm	mm
05075670001	206169	9x12	2,5	2,5-25	2-18	217	17,5	180,0	137	35	24	20	8 35/64"	5 25/64"	1 3/8"	15/16"		1
05075670010 <sup>1)</sup>	206206	9x12	2,5	2,5-25	2-18	217	17,5	180,0	137	35	24	20	8 35/64"	5 25/64"	1 3/8"	15/16"		1

<sup>1)</sup>Any presetting which differs from this value, can be set to a desired torque value within the specified metered range upon request. The desired settings can be made in the following units: Nm, kgf. m, lbf. ft., ozf. in., dN. m, kgf. cm, lbf. in, in. oz, cN. m, gf. m, ft. lb, gf. cm, in. lb.

<sup>2)</sup> $S_k$  = Depth gauge of test attachment to pivot point;  $l_k$  = Length of holding position to torque measurement point

### Click-Torque XP 2 pre-set adjustable torque wrench for insert tools, 10-50 Nm, 10 Nm

- With square socket (9x12 mm) for interchangeable plug-in tools; clockwise and anti-clockwise torque-control
- Measuring range: 10-50 Nm; Precise to +/- 2% as per DIN EN ISO 6789-1:2017-07
- Pre-set torque values can be changed within the metered range in the test laboratory

### Click-Torque XP 2 pre-set adjustable torque wrench for insert tools, 10-50 Nm, 10 Nm



		EAN					$S_k$	$l_k$										
Code			Nm	Nm	lbf. ft.	mm	mm	mm	mm	mm	mm	mm	mm	mm	mm	mm	mm	mm
05075671001	206176	9x12	10,0	10-50	8-36	262	17,5	225,0	137	35	24	20	10 5/16"	5 25/64"	1 3/8"	15/16"		1
05075671010 <sup>1)</sup>	206213	9x12	10,0	10-50	8-36	262	17,5	225,0	137	35	24	20	10 5/16"	5 25/64"	1 3/8"	15/16"		1

<sup>1)</sup>Any presetting which differs from this value, can be set to a desired torque value within the specified metered range upon request. The desired settings can be made in the following units: Nm, kgf. m, lbf. ft., ozf. in., dN. m, kgf. cm, lbf. in, in. oz, cN. m, gf. m, ft. lb, gf. cm, in. lb.

<sup>2)</sup> $S_k$  = Depth gauge of test attachment to pivot point;  $l_k$  = Length of holding position to torque measurement point

### Click-Torque XP 3 pre-set adjustable torque wrench for insert tools, 15-100 Nm, 15 Nm

- With square socket (9x12 mm) for interchangeable plug-in tools; clockwise and anti-clockwise torque-control
- Measuring range: 15-100 Nm; Precise to +/- 2% as per DIN EN ISO 6789-1:2017-07
- Pre-set torque values can be changed within the metered range in the test laboratory

### Click-Torque XP 3 pre-set adjustable torque wrench for insert tools, 15-100 Nm, 15 Nm

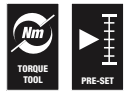

		EAN																	
Code	4013288		Nm	Nm	lbf. ft.	mm	S <sub>k</sub>	l <sub>k</sub>	mm	mm	mm	mm	mm	mm	mm	mm	mm	mm	mm
05075672001	206183	9x12	15,0	15-100	11-74	332	17,5	296,0	137	35	24	20	13 5/64"	5 25/64"	1 3/8"	15/16"			1
05075672010 <sup>1)</sup>	207999	9x12	15,0	15-100	11-74	332	17,5	296,0	137	35	24	20	13 5/64"	5 25/64"	1 3/8"	15/16"			1

<sup>1)</sup> Any presetting which differs from this value, can be set to a desired torque value within the specified metered range upon request. The desired settings can be made in the following units: Nm, kgf. m, lbf. ft., ozf. in., dN. m, kgf. cm, lbf. in, in. oz, cN. m, gf. m, ft. lb, gf. cm, in. lb.  
<sup>2)</sup> S<sub>k</sub> = Depth gauge of test attachment to pivot point; l<sub>k</sub> = Length of holding position to torque measurement point

### Click-Torque XP 4 pre-set adjustable torque wrench for insert tools, 20-250 Nm, 20 Nm

- With square socket (14 x18) for interchangeable plug-in tools; clockwise and anti-clockwise torque-control
- Measuring range: 20-250 Nm; Precise to +/- 2% as per DIN EN ISO 6789-1:2017-07
- Pre-set torque values can be changed within the metered range in the test laboratory
- The Click-Torque collar is placed around the tube of the Wera Click-Torque torque wrench. It prevents the handle from touching the ground. Dirt and damage are avoided

### Click-Torque XP 4 pre-set adjustable torque wrench for insert tools, 20-250 Nm, 20 Nm

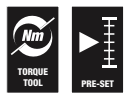

		EAN																	
Code	4013288		Nm	Nm	lbf. ft.	mm	S <sub>k</sub>	l <sub>k</sub>	mm	mm	mm	mm	mm	mm	mm	mm	mm	mm	mm
05075673001	206190	14x18	20,0	20-250	15-184	457	25,5	430,0	145	41	32	26	17 63/64"	5 45/64"	1 39/64"	1 17/64"			1
05075673010 <sup>1)</sup>	206220	14x18	20,0	20-250	15-184	457	25,5	430,0	145	41	32	26	17 63/64"	5 45/64"	1 39/64"	1 17/64"			1

<sup>1)</sup> Any presetting which differs from this value, can be set to a desired torque value within the specified metered range upon request. The desired settings can be made in the following units: Nm, kgf. m, lbf. ft., ozf. in., dN. m, kgf. cm, lbf. in, in. oz, cN. m, gf. m, ft. lb, gf. cm, in. lb.  
<sup>2)</sup> S<sub>k</sub> = Depth gauge of test attachment to pivot point; l<sub>k</sub> = Length of holding position to torque measurement point

## NEW

### Simple and error-free determination of the torque value

The laser-engraved, abrasion-proof QR code makes it easier to determine the correct torque value depending on the torque wrench and insert tool used. Simply scan with your smartphone and tablet (if available, both QR codes: Torque wrench and insert tool).

A website opens automatically which recognizes the scanned tools (no app needed!). Then enter the required torque value; the corrected value is determined automatically. No need to use formulas/calculations.



[www.wera.de/torque-advisor](http://www.wera.de/torque-advisor)

### 7880 Joker XXL Self-setting insert spanner for wrench sizes 24-32 mm, 14x18 mm

- For torque wrenches of the Click-Torque X series with 14x18 mm holder
- The adjustable 7880 Joker covers all metric and imperial dimensions in the respective field of application
- Automatic and continuous gripping of the hexagon screw or bolt
- Lever mechanism when gripping avoids slippage and damage
- Fast and consistent screwdriving without removing the wrench thanks to mechanical ratchet function
- Return angle of only 30° through placement in the corner-width rectangular prisms in the open end
- The laser-engraved, abrasion-proof QR code makes it easier to determine the correct torque value depending on the torque wrench and insert tool used

### 7880 Joker XXL Self-setting insert spanner for wrench sizes 24-32 mm, 14x18 mm

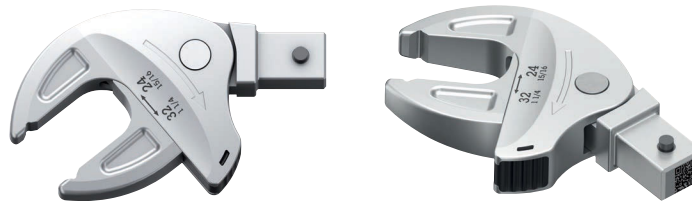

	EAN	□										
Code	4013288	mm	mm	mm	mm	mm	mm	mm	mm	mm	mm	
05020173001	229380	14x18	24-32	1 <sup>5</sup> / <sub>16</sub> "-1 <sup>1</sup> / <sub>4</sub> "	24,0 27,0 30,0 32,0	62,2 68,0 70,2 70,4	1 <sup>5</sup> / <sub>16</sub> " 3 <sup>1</sup> / <sub>32</sub> " 1" 1 <sup>1</sup> / <sub>16</sub> " 1 <sup>1</sup> / <sub>8</sub> " 1 <sup>3</sup> / <sub>16</sub> " 1 <sup>1</sup> / <sub>4</sub> "	62,2 63,9 65,4 66,4 69,5 70,1 70,2	113,5	1		

### 7880 Joker XL Self-setting insert spanner for wrench sizes 19-24 mm, 14x18 mm

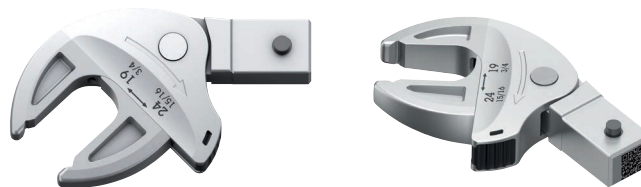

	EAN	□										
Code	4013288	mm	mm	mm	mm	mm	mm	mm	mm	mm	mm	
05020172001	229366	14x18	19-24	19,0 20,0 21,0 22,0 24,0	51,6 53,6 55,4 56,7 56,7	3/4" 2 <sup>5</sup> / <sub>32</sub> " 1 <sup>3</sup> / <sub>16</sub> " 7/8" 1 <sup>5</sup> / <sub>16</sub> "	51,6 53,3 54,7 56,7 56,7	3/4"-1 <sup>5</sup> / <sub>16</sub> "	95	1		

## 7880 Joker L Self-setting insert spanner for wrench sizes 16-19 mm, 14x18mm

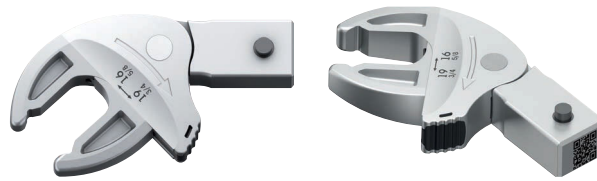

	EAN									
Code	4013288	mm	mm		mm			mm	mm	
05020171001	229359	14x18	16-19	5/8"-3/4"	16,0 17,0 18,0 19,0	44,6 46,7 48,2 49,1	5/8" 11/16" 3/4"	44,4 47,3 49,1	85,5	1

### 7770 Open end insert, 9x12 mm

- Square insert tool 9x12 mm
- For torque wrenches of the Click-Torque X series with 9x12 mm holder
- Application: Hexagon screw heads or nuts
- With safety pin
- The chrome-vanadium steel version makes the plug-in tools suitable for heavy loads

### 7770 Open end insert, 9x12 mm

#### Form A

05078600001  
05078601001  
05078602001  
05078603001  
05078604001  
05078605001



#### Form B

05078606001  
05078607001  
05078608001  
05078609001  
05078610001  
05078611001  
05078612001



	EAN									
Code	4013288	mm	mm	mm	mm	mm	mm	mm	mm	
05078600001	196101	9x12	7	17,5	39,0	22,0	22,0	5,0		1
05078601001	196095	9x12	8	17,5	39,0	22,0	22,0	5,0		1
05078602001	196088	9x12	9	17,5	39,0	22,0	22,0	5,0		1
05078603001	196071	9x12	10	17,5	39,0	22,0	22,0	5,0		1
05078604001	196064	9x12	11	17,5	39,0	22,0	22,0	5,0		1
05078605001	196057	9x12	12	17,5	39,0	22,0	22,0	5,0		1
05078606001	196040	9x12	13	17,5	41,0	24,0	30,0	7,0		1
05078607001	196033	9x12	14	17,5	41,0	24,0	30,0	7,0		1
05078608001	196026	9x12	15	17,5	41,0	24,0	30,0	7,0		1
05078609001	196019	9x12	16	17,5	41,0	24,0	30,0	7,0		1
05078610001	196002	9x12	17	17,5	41,0	24,0	30,0	7,0		1
05078611001	196118	9x12	18	17,5	41,0	24,0	30,0	7,0		1
05078612001	196125	9x12	19	17,5	41,0	24,0	30,0	7,0		1

## 7780 Open end insert, 14x18 mm

Open end insert, for hexagon screw heads or nuts; for torque wrenches of the Click-Torque X series with 14x18 mm holder.

### 7780 Open end insert, 14x18 mm

#### Form A

05078670001



#### Form B

05078671001  
05078672001  
05078673001  
05078674001  
05078675001  
05078676001



#### Form C

05078677001  
05078678001  
05078679001  
05078680001  
05078681001



#### Form D

05078682001  
05078683001  
05078684001  
05078685001  
05078686001  
05078687001



	EAN									
Code	4013288	mm	mm	mm	mm	mm	mm	mm	mm	
05078670001	196729	14x18	13	25,5	56,0	32,0	30,0	7,0	1	
05078671001	196736	14x18	14	25,5	58,0	33,0	32,0	8,0	1	
05078672001	196743	14x18	15	25,5	58,0	33,0	32,0	8,0	1	
05078673001	196750	14x18	16	25,5	58,0	33,0	32,0	9,0	1	
05078674001	196767	14x18	17	25,5	58,0	33,0	32,0	9,0	1	
05078675001	196774	14x18	18	25,5	58,0	33,0	32,0	9,7	1	
05078676001	196781	14x18	19	25,5	58,0	33,0	32,0	9,7	1	
05078677001	196798	14x18	21	25,5	61,0	36,0	52,0	11,0	1	
05078678001	196804	14x18	22	25,5	61,0	36,0	52,0	11,0	1	
05078679001	196811	14x18	24	27,5	61,0	36,0	52,0	12,0	1	
05078680001	196828	14x18	26	30,0	61,0	36,0	52,0	13,0	1	
05078681001	196835	14x18	27	30,0	61,0	36,0	52,0	13,0	1	
05078682001	196842	14x18	29	30,0	61,0	36,0	52,0	14,0	1	
05078683001	196859	14x18	30	30,0	61,0	36,0	52,0	14,0	1	
05078684001	196866	14x18	32	32,5	61,0	36,0	52,0	14,0	1	
05078685001	196873	14x18	36	32,5	61,0	36,0	52,0	15,0	1	
05078686001	196880	14x18	38	32,5	61,0	36,0	52,0	15,0	1	
05078687001	196897	14x18	41	32,5	61,0	36,0	52,0	15,0	1	

## 7771 Ring spanner insert, 9x12 mm

Ring spanner insert, for hexagon screw heads or nuts; for torque wrenches of the Click-Torque X series with 9x12 mm holder.

### 7771 Ring spanner insert, 9x12 mm

#### Form A

05078620001  
05078621001  
05078622001  
05078623001  
05078624001



#### Form B









05078625001  
05078626001  
05078627001  
05078628001  
05078629001  
05078630001  
05078631001  
05078632001



#### Form C

05078633001



	EAN								
Code	4013288	mm	mm	mm	mm	mm	mm	mm	
05078620001	196163	9x12	7	17,5	41,0	24,0	22,0	8,0	1
05078621001	196156	9x12	8	17,5	41,0	24,0	22,0	8,0	1
05078622001	196170	9x12	9	17,5	41,0	24,0	22,0	8,0	1
05078623001	196187	9x12	10	17,5	41,0	24,0	22,0	8,0	1
05078624001	196194	9x12	11	17,5	41,0	24,0	22,0	8,0	1
05078625001	196200	9x12	12	17,5	44,0	27,0	22,0	11,0	1
05078626001	196217	9x12	13	17,5	44,0	27,0	22,0	11,0	1
05078627001	196224	9x12	14	17,5	44,0	27,0	22,0	11,0	1
05078628001	196231	9x12	15	17,5	44,0	27,0	22,0	11,0	1
05078629001	196248	9x12	16	17,5	44,0	27,0	22,0	11,0	1
05078630001	196255	9x12	17	17,5	44,0	27,0	22,0	11,0	1
05078631001	196262	9x12	18	17,5	44,0	27,0	22,0	11,0	1
05078632001	196279	9x12	19	17,5	44,0	27,0	22,0	11,0	1
05078633001	196286	9x12	21	17,5	51,0	34,0	33,0	15,0	1



## 7781 Ring spanner insert, 14x18 mm

Ring spanner insert, for hexagon screw heads or nuts; for torque wrenches of the Click-Torque X series with 14x18 mm holder.

### 7781 Ring spanner insert, 14x18 mm

**Form A**  
05078690001  
05078691001  
05078692001



**Form B**  
05078693001  
05078694001  
05078695001  
05078696001  
05078697001  
05078698001  
05078699001



**Form C**  
05078700001  
05078701001  
05078702001  
05078703001  
05078704001  
05078705001



	EAN									
Code	4013288	mm	mm	mm	mm	mm	mm	mm	mm	
05078690001	196132	14x18	13	25,5	62,0	37,0	30,0	11,0	1	
05078691001	196576	14x18	14	25,5	62,0	37,0	30,0	11,0	1	
05078692001	196583	14x18	15	25,5	62,0	37,0	30,0	11,0	1	
05078693001	196590	14x18	16	25,5	64,0	39,0	28,0	12,0	1	
05078694001	196606	14x18	17	25,5	64,0	39,0	28,0	12,0	1	
05078695001	196620	14x18	18	25,5	64,0	39,0	28,0	12,0	1	
05078696001	196637	14x18	19	25,5	64,0	39,0	28,0	12,0	1	
05078697001	196644	14x18	21	25,5	64,0	39,0	28,0	12,0	1	
05078698001	196613	14x18	22	25,5	64,0	39,0	28,0	12,0	1	
05078699001	196651	14x18	24	25,5	64,0	39,0	28,0	12,0	1	
05078700001	196668	14x18	27	25,5	81,0	56,0	53,0	21,0	1	
05078701001	196675	14x18	30	25,5	81,0	56,0	53,0	21,0	1	
05078702001	196682	14x18	32	25,5	81,0	56,0	53,0	21,0	1	
05078703001	196699	14x18	34	28,0	81,0	56,0	53,0	21,0	1	
05078704001	196705	14x18	36	28,0	81,0	56,0	53,0	21,0	1	
05078705001	196712	14x18	41	30,0	81,0	56,0	53,0	21,0	1	

### 7772 A Ratchet insert, reversible, 9x12 mm

Ratchet insert, reversible, for 1/4" square socket wrench inserts and 1/4" connecting parts with square drive; for torque wrenches of the Click-Torque X series with 9x12 mm holder.

#### 7772 A Ratchet insert, reversible, 9x12 mm



	EAN									
<b>Code</b>	4013288	mm		mm	mm	mm	mm	mm	mm	
05078635001	196347	9x12	1/4"	17,5	49,0	32,0	28,0	15,0		1

### 7772 B Ratchet insert, reversible, 9x12 mm

Ratchet insert, reversible, for 3/8" square socket wrench inserts and 3/8" connecting parts with square drive; for torque wrenches of the Click-Torque X series with 9x12 mm holder.

#### 7772 B Ratchet insert, reversible, 9x12 mm



	EAN									
<b>Code</b>	4013288	mm		mm	mm	mm	mm	mm	mm	
05078636001	196446	9x12	3/8"	17,5	52,0	35,0	35,0	21,0		1

### 7772 C Ratchet insert, reversible, 9x12 mm

Ratchet insert, reversible, for 1/2" square socket wrench inserts and 1/2" connecting parts with square drive; for torque wrenches of the Click-Torque X series with 9x12 mm holder.

#### 7772 C Ratchet insert, reversible, 9x12 mm



	EAN									
<b>Code</b>	4013288	mm		mm	mm	mm	mm	mm	mm	
05078637001	196453	9x12	1/2"	20,0	58,0	41,0	42,0	23,0		1

### 7782 C Ratchet insert, reversible, 14x18 mm

Ratchet insert, reversible, for 1/2" square socket wrench inserts and 1/2" connecting parts with square drive; for torque wrenches of the Click-Torque X series with 14x18 mm holder.

#### 7782 C Ratchet insert, reversible, 14x18 mm



	EAN									
<b>Code</b>	4013288	mm		mm	mm	mm	mm	mm	mm	
05078707001	196552	14x18	1/2"	20,0	66,0	41,0	42,0	23,0		1

### 7782 E Ratchet insert, reversible, 14x18 mm

Ratchet insert, reversible, for 3/4" square socket wrench inserts and 3/4" connecting parts with square drive; for torque wrenches of the Click-Torque X series with 14x18 mm holder.

#### 7782 E Ratchet insert, reversible, 14x18 mm



	EAN									
<b>Code</b>	4013288	mm		mm	mm	mm	mm	mm	mm	
05078708001	196569	14x18	3/4"	30,0	90,0	65,0	65,0	36,0		1

### 7773 A Square drive insert, 9x12 mm

Square drive insert, for 1/4" square socket wrench inserts and 1/4" connecting parts with square drive; for torque wrenches of the Click-Torque X series with 9x12 mm holder.

#### 7773 A Square drive insert, 9x12 mm



	EAN									
<b>Code</b>	4013288	mm		mm	mm	mm	mm	mm	mm	
05078200001	023742	9x12	1/4"	17,5	44,0	28,0	21,0	14,0		1

### 7773 B Square drive insert, 9x12 mm

Square drive insert, for  $\frac{3}{8}$ " square socket wrench inserts and  $\frac{3}{8}$ " connecting parts with square drive; for torque wrenches of the Click-Torque X series with 9x12 mm holder.

#### 7773 B Square drive insert, 9x12 mm



	EAN									
<b>Code</b>	4013288	mm		mm	mm	mm				
05078205001	023759	9x12	$\frac{3}{8}$ "	17,5	44,0	28,0	21,0	14,0		1

### 7773 C Square drive insert, 9x12 mm

Square drive insert, for  $\frac{1}{2}$ " square socket wrench inserts and  $\frac{1}{2}$ " connecting parts with square drive; for torque wrenches of the Click-Torque X series with 9x12 mm holder.

#### 7773 C Square drive insert, 9x12 mm



	EAN									
<b>Code</b>	4013288	mm		mm	mm	mm	mm	mm		
05078210001	023766	9x12	$\frac{1}{2}$ "	17,5	44,0	28,0	21,0	14,0		1

### 7783 C Square drive insert, 14x18 mm

Square drive insert, for  $\frac{1}{2}$ " square socket wrench inserts and  $\frac{1}{2}$ " connecting parts with square drive; for torque wrenches of the Click-Torque X series with 14x18 mm holder.

#### 7783 C Square drive insert, 14x18 mm



	EAN									
<b>Code</b>	4013288	mm		mm	mm	mm	mm	mm		
05078345001	024183	14x18	$\frac{1}{2}$ "	25,5	65,0	40,0	30,0	18,0		1

### 7783 E Push-through square insert tool, 14x18 mm

Square drive insert, for  $\frac{3}{4}$ " square socket wrench inserts and  $\frac{3}{4}$ " connecting parts with square drive; for torque wrenches of the Click-Torque X series with 14x18 mm holder.

#### 7783 E Push-through square insert tool, 14x18 mm



	EAN								
<b>Code</b>	4013288	mm		mm	mm	mm	mm	mm	
05078710001	196460	14x18	$\frac{3}{4}$ "	25,5	70,0	45,0	40,0	25,0	1

### 7774/1 Bit adapter insert, $\frac{1}{4}$ ", 9x12 mm

Bit adapter insert,  $\frac{1}{4}$ "; for torque wrenches of the Click-Torque X series with 9x12 mm holder.

#### 7774/1 Bit adapter insert, $\frac{1}{4}$ ", 9x12 mm



	EAN								
<b>Code</b>	4013288	mm		mm	mm	mm	mm	mm	
05078640001	196316	9x12	$\frac{1}{4}$ "	17,5	42,0	25,0	22,0	12,5	1

### 7774/2 Bit adapter insert, $\frac{5}{16}$ ", 9x12 mm

Bit adapter insert,  $\frac{5}{16}$ "; for torque wrenches of the Click-Torque X series with 9x12 mm holder.

#### 7774/2 Bit adapter insert, $\frac{5}{16}$ ", 9x12 mm



	EAN								
<b>Code</b>	4013288	mm		mm	mm	mm	mm	mm	
05078641001	196309	9x12	$\frac{5}{16}$ "	17,5	42,0	25,0	22,0	12,5	1

### 7774/3 Bit adapter insert, 5/16", 14x18 mm

Bit adapter insert, 5/16"; for torque wrenches of the Click-Torque X series with 14x18 mm holder.

### 7774/3 Bit adapter insert, 5/16", 14x18 mm



	EAN									
Code	4013288	mm		mm	mm	mm	mm	mm	mm	
05078642001	196293	14x18	5/16"	25,5	58,0	33,0	30,0	13,0		1

### 7775 Open ring spanner insert, 9x12 mm

Open ring spanner insert, for hexagon screw heads or nuts; for torque wrenches of the Click-Torque X series with 9x12 mm holder.

### 7775 Open ring spanner insert, 9x12 mm

Form **A**

- 05078650001
- 05078651001
- 05078652001
- 05078653001
- 05078654001
- 05078655001



Form **B**

- 05078656001
- 05078657001
- 05078658001



	EAN									
Code	4013288	mm	mm	mm	mm	mm	mm	mm	mm	
05078650001	196330	9x12	10	17,5	44,0	27,0	22,0	11,0		1
05078651001	196361	9x12	11	17,5	44,0	27,0	22,0	11,0		1
05078652001	196378	9x12	12	17,5	44,0	27,0	22,0	11,0		1
05078653001	196385	9x12	13	17,5	44,0	27,0	22,0	11,0		1
05078654001	196392	9x12	14	17,5	44,0	27,0	22,0	11,0		1
05078655001	196408	9x12	17	17,5	44,0	27,0	22,0	11,0		1
05078656001	196415	9x12	18	17,5	49,0	32,0	33,0	15,0		1
05078657001	196422	9x12	19	17,5	49,0	32,0	33,0	15,0		1
05078658001	196439	9x12	22	17,5	49,0	32,0	33,0	15,0		1

### 7776 External TORX® insert, 9x12 mm

External TORX® insert; for torque wrenches of the Click-Torque X series with 9x12 mm holder.

### 7776 External TORX® insert, 9x12 mm

Form **A**

- 05078660001
- 05078661001
- 05078662001
- 05078663001



Form **B**

- 05078664001



	EAN									
Code	4013288	mm		mm	mm	mm	mm	mm	mm	
05078660001	195968	9x12	TX 6	17,5	40,0	23,0	22,0	8,0		1
05078661001	195975	9x12	TX 8	17,5	40,0	23,0	22,0	8,0		1
05078662001	195982	9x12	TX 10	17,5	40,0	23,0	22,0	8,0		1
05078663001	195999	9x12	TX 12	17,5	40,0	23,0	22,0	8,0		1
05078664001	196149	9x12	TX 14	17,5	45,0	28,0	22,0	11,0		1

## 7786 External TORX® insert, 14x18 mm

External TORX® insert; for torque wrenches of the Click-Torque X series with 14x18 mm holder.

### 7786 External TORX® insert, 14x18 mm

Form **A**  
05078714001  
05078715001



Form **B**  
05078716001  
05078717001



	EAN									
Code	4013288	mm		mm	mm	mm	mm	mm	mm	
05078714001	196507	14x18	TX 14	25,5	37,0	62,0	30,0	11,0	1	
05078715001	196514	14x18	TX 18	25,5	37,0	62,0	30,0	11,0	1	
05078716001	196521	14x18	TX 20	25,5	40,0	65,0	32,0	12,0	1	
05078717001	196538	14x18	TX 24	25,5	40,0	65,0	32,0	12,0	1	

## 7779/1 Adapter insert, 9x12 mm

Adapter insert for the use of square plug-in tools 14x18 mm in torque wrenches with internal square 9x12 mm; for torque wrenches of the Click-Torque X series with 9x12 mm holder.

### 7779/1 Adapter insert, 9x12 mm



	EAN								
Code	4013288	mm	mm	mm	mm	mm	mm	mm	
05078666001	196323	9x12	14x18	49,0	33,0	32,0	26,0	1	

## 7779/2 Adapter insert, 14x18 mm

Adapter insert for the use of square plug-in tools 9x12 mm in torque wrenches with internal square 14x18 mm; for torque wrenches of the Click-Torque X series with 14x18 mm holder.

### 7779/2 Adapter insert, 14x18 mm



	EAN								
Code	4013288	mm	mm	mm	mm	mm	mm	mm	
05078667001	196545	14x18	9x12	52,0	27,0	28,0	21,0	1	







### 7790/1 Push-fit weld-on adapter, 9x12 mm

Push-fit weld-on adapter; for torque wrenches of the Click-Torque X series with 9x12 mm holder.

- For welding on specifically required tools
- Welding should ideally be carried out by a specialist welding company

### 7790/1 Push-fit weld-on adapter, 9x12 mm



	EAN						
<b>Code</b>	4013288	mm	mm	mm	mm	mm	
05078720001	196354	9x12	24,0	8,0	22,0	14,0	1







### 7790/2 Push-fit weld-on adapter, 14x18 mm

Push-fit weld-on adapter; for torque wrenches of the Click-Torque X series with 14x18 mm holder.

- For welding on specifically required tools
- Welding should ideally be carried out by a specialist welding company

### 7790/2 Push-fit weld-on adapter, 14x18 mm



	EAN						
<b>Code</b>	4013288	mm	mm	mm	mm	mm	
05078721001	196477	14x18	38,0	13,0	31,0	22,0	1



### Click-Torque collar

The collar prevents the handle of the Click-Torque torque wrench from touching the ground. Dirt and damage are avoided when putting down the tool while working.

Also prevents the tool from rolling away, and it serves to fix the Click-Torque torque wrench in the storage/transport box. The collar can be easily attached to the torque wrench tube and is removable.

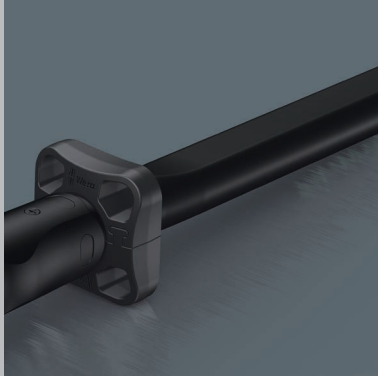

### 7762 Click-Torque collar M3

Click-Torque collar as an accessory for Click-Torque Torque wrenches B 1, B 2, C 1, C 2, C 3, C 4, X 2, X 3, X 4, X 5, XP 4, Click-Torque Push R/L C 2 and Click-Torque Push R/L C 3.

### 7762 Click-Torque collar M3



	EAN							
<b>Code</b>	4013288	mm	mm	mm				
05078709001	211767	55,0	55,0	21,5				1

### 7761 Click-Torque collar M4

Click-Torque collar as an accessory for Click-Torque Torque wrenches C 5 and X 6.

### 7761 Click-Torque collar M4



	EAN							
<b>Code</b>	4013288	mm	mm	mm				
05078706001	211750	55,0	55,0	21,5				1

### 7763 Click-Torque collar M5

Click-Torque collar as an accessory for Click-Torque Torque wrench E 1 and Click-Torque Push R/L E 1.

### 7763 Click-Torque collar M5



	EAN							
<b>Code</b>	4013288	mm	mm	mm				
05078711001	211774	73,0	73,0	27,0				1

## 2090 Impact driver 90 Nm

High quality impact driver that can loosen rigid connections without the use of power tools simply by the force of the impact. The Wera impact drivers have a particularly high efficiency thanks to their robust, double-curved design.

Impact forces are converted into rotary motion. The use of compressed air equipment becomes unnecessary. For M 4 to M 8 screws. Drive:  $\frac{5}{16}$ " hexagon socket.

- To loosen and tighten screws without the use of power tools
- Impact forces are converted into rotary motion
- The double-curved design is particularly efficient
- $\frac{5}{16}$ " hexagon socket take-up

## 2090 Impact driver 90 Nm



	EAN					
Code	4013288		mm			
05072014001	180926	$\frac{5}{16}$ "	142,0	5 $\frac{19}{32}$ "		1

## 2090/17 Impact driver set

- 2090 impact driver, 90 Nm with many accessories
- To loosen and tighten screws without the use of power tools
- Impact forces are converted into rotary motion
- The double-curved design is particularly efficient
- $\frac{5}{16}$ " hexagon socket take-up

## 2090/17 Impact driver set



Code	EAN		
05072017001	179777		1
		<b>2090 90 Nm</b> 1x $\frac{5}{16}$ "x142,0	
		<b>851/2 Z PH</b> 1x PH 2x32; 1x PH 3x32	
		<b>851/2 PH</b> 1x PH 4x32	
		<b>800/2</b> 1x 2,0x12,0x41	
		<b>840/2 Z</b> 1x 5x30; 1x 6x30; 1x 8x30; 1x 10x30	
		<b>840/2</b> 1x 7,0x30	
		<b>867/2 Z TORX®</b> 1x TX 30x35; 1x TX 40x35; 1x TX 45x35; 1x TX 50x35; 1x TX 55x35	
		<b>870/2</b> 1x $\frac{3}{8}$ "x $\frac{5}{16}$ " <sup>1)</sup> ; 1x $\frac{1}{2}$ "x $\frac{5}{16}$ " <sup>1)</sup>	

<sup>1)</sup>With friction ball; for manual nut spinner sockets

# TORQUE Test Values



## Slotted Tools

Drives: DIN ISO 2380, VSM 35601.  
TORQUE values evaluated in test gages according to DIN ISO 2380 on TORQUE testing equipment.



## Hexagon Tools

Drives: DIN ISO 2936. TORQUE values evaluated in test gages according to DIN ISO 2936 on TORQUE testing equipment.



## PH and PZ Tools

Drives: DIN 5260, ISO 8764 and SMS-SS 1687.  
TORQUE values evaluated in test gages according to DIN 5261, ISO 8764 on TORQUE testing equipment.



## Tools with TORQ-SET® drive

TORQUE values evaluated with testing gages of Phillips Screw Company, licensor of TORQ-SET®, on TORQUE testing equipment.

a x b mm	TORQUE in Nm (min)	
	handuse	poweruse
0,3 x 2,0	0,18	0,20
0,4 x 2,0	0,30	0,35
0,4 x 2,5	0,40	0,45
0,5 x 3,0	0,70	0,80
0,5 x 3,5	0,90	0,98
0,6 x 3,5	1,30	1,40
0,6 x 4,0	1,40	1,61
0,6 x 4,5	-	1,80
0,8 x 4,0	2,60	2,90
0,8 x 4,5	2,88	
0,8 x 5,0	3,20	3,58
0,8 x 5,5	3,50	3,90
1,0 x 5,5	5,50	6,20
1,0 x 6,5	6,50	7,28
1,0 x 7,0	7,0	7,80
1,2 x 6,5	9,40	10,50
1,2 x 7,0	10,0	11,28
1,2 x 8,0	11,5	12,90
1,4 x 9,0	17,6	19,70
1,5 x 13	29	32
1,6 x 8,0	20,5	22,9
1,6 x 9,0	23	25
1,6 x 10	25,6	28,7
2,0 x 12	48,0	53
2,0 x 13	52	58
2,5 x 14	87	98
2,5 x 16	100	112
3,0 x 18	162	181

SW (mm)	TORQUE in Nm (min)
0,7	0,08
0,9	0,18
1,3	0,53
1,5	0,82
2,0	1,9
2,5	3,8
3	6,6
3,5	11
4	16
4,5	24
5	30
6	52
7	78
8	120
9	180
10	220
11	295
12	370
13	480
14	590
17	1000
19	1000
22	1000
24	1000
27	1000

	TORQUE in Nm (min)	
	handuse	poweruse
0	1,0	1,0
1	3,5	3,9
2	8,2	10,3
3	19,5	32,0
4	38,0	88,7

	TORQUE in Nm (min)	
	Bits	Screw- drivers
2	1,1	1,1
3	1,7	1,7
4	2,8	2,8
5	4,0	4,0
6	5,1	5,1
8	8,5	8,5
10	11,3	11,3
1/4"	28	17
5/16"	56	28
3/8"	102	62
7/16"	147	
1/2"	249	
9/16"	271	
5/8"	339	



**Test torques for tools with TORX® and TORX PLUS® drives**  
Test torques evaluated with testing gages from the TORX® and TORX PLUS® licensor (Acument Global Technologies Inc.)."

	TORQUE in Nm (min.)					
	TORX®			TORX PLUS®		
Bit	Resis-Bit	Screw-driver	Bit	Resis-Bit	Screw-drivers	
1	0,10	-	0,08	0,11		
2	0,14	-	0,12	0,16		
3	0,25	-	0,21	0,28		
4	0,37	-	0,31	0,44		
5	0,51	-	0,43	0,61		
6	0,91	-	0,75	1,11		0,92
7	1,7	1,4	1,4	2,10		1,68
8	2,6	2,2	2,2	3,21	2,5	2,79
9	3,4	2,9	2,8	4,19	3,3	3,49
10	4,5	3,8	3,7	5,42	4,3	4,47
15	7,7	6,5	6,4	9,62	7,3	8,06
20	12,7	10,8	10,5	16,15	11,9	13,41
25	19,0	16,1	15,9	23,50	17,4	19,58
27	26,9	22,9	22,5	34,62	25,1	28,95
30	37,4	31,8	31,1	47,18	33,5	39,34
40	65,1	55,3	54,1	82,08	59,4	68,40
45	104	88	86	137,38	97,3	114,44
50	159	135	132	194,54	152,4	162,14
55	257	218	218	352,10	291,5	299,25
60	445	379	379	566,11	483,0	481,24
70	701	596	600	910,40	713,3	773,91

### Important note:

After the torque test with the specified minimum value, the screwdriver must not show any permanent deformation or other damage to the tip of the screwdriver that would impair its usability.



# Dimensions Of Profiles

## TORX® Recess Screws

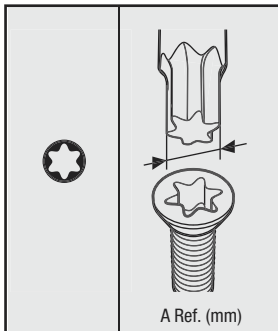

TX 1	0,84
TX 2	0,94
TX 3	1,12
TX 4	1,30
TX 5	1,37
TX 6	1,65
TX 7	1,97
TX 8	2,30
TX 9	2,48
TX 10	2,72
TX 15	3,26
TX 20	3,84
TX 25	4,40
TX 27	4,96
TX 30	5,49
TX 40	6,60
TX 45	7,77
TX 50	8,79
TX 55	11,17
TX 60	13,20
TX 70	15,49

## TORX PLUS® Recess Screws

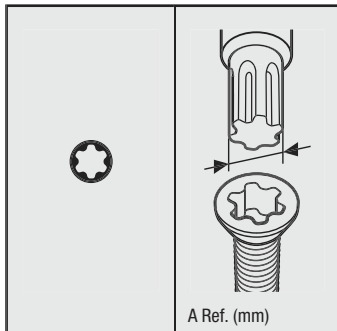

1 IP	0,84
2 IP	0,95
3 IP	1,13
4 IP	1,29
5 IP	1,41
6 IP	1,69
7 IP	1,97
8 IP	2,29
9 IP	2,48
10 IP	2,72
15 IP	3,25
20 IP	3,84
25 IP	4,39
27 IP	4,95
30 IP	5,49
40 IP	6,60
45 IP	7,77
50 IP	8,79
55 IP	11,16
60 IP	13,20
70 IP	15,48

## TORQ-SEI® Recess Screws

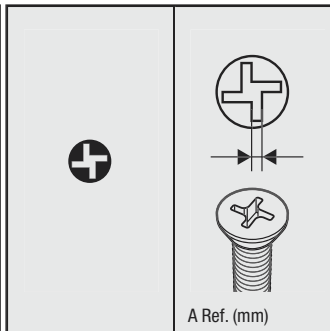

0	0,43
1	0,43
2	0,43
3	0,48
4	0,56
5	0,63
6	0,71
8	0,84
10	0,96
1/4"	1,27
5/16"	1,60
3/8"	1,90
7/16"	2,23
1/2"	2,54

## TRI-WING® Recess Screws

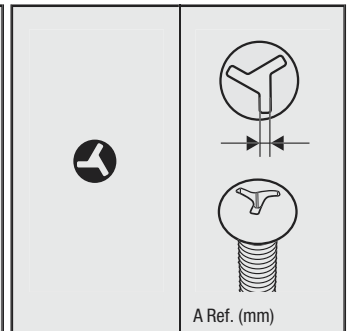

0	0,45
1	0,57
2	0,75
3	0,95
4	1,08
5	1,23
6	1,54
7	1,87
8	2,17
9	2,48
10	2,78

## XZN Recess Screws

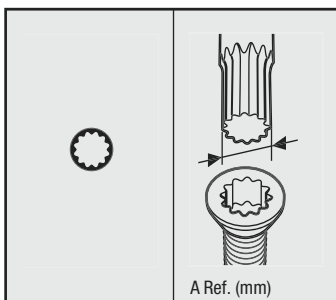

M 4	3,83
M 5	4,80
M 6	6,00
M 8	7,20
M 10	9,60
M 12	11,41
M 14	13,22
M 16	15,63
M 18	16,85
M 20	19,25

## Square Recess Screws

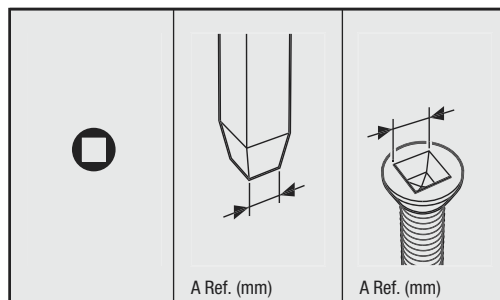

00	1,27	1,4
0	1,78	2
1	2,31	2,5
2	2,85	3,1
3	3,37	3,7
4	4,84	5,1

## Spanner Recess Screws

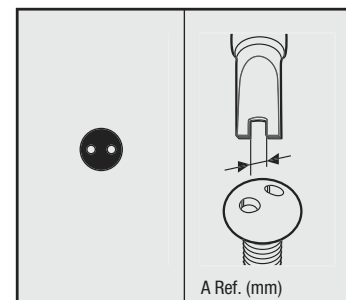

4	1,52
6	2,41
8	2,79
10	3,30

# TORQUE Conversion Table

Conversion Units	SI Units			Metric scale		USA GB scale		
	cNm	dNm	Nm	cmkg	mkg	ft.lb	in.lb	in.oz
1 cNm =	1	0,1	0,01	0,1020	0,0010	0,0074	0,0885	1,4161
1 dNm =	10	1	0,1	1,0197	0,0102	0,0738	0,8851	14,1612
1 Nm =	100	10	1	10,1972	0,1020	0,7376	8,8508	141,6123
1 cmkg =	9,8067	0,9807	0,0981	1	0,0100	0,0723	0,8680	13,8874
1 mkg =	980,6650	98,0665	9,8067	100	1	7,2330	86,7964	1388,7422
1 ft.lb =	135,5818	13,5581	1,3558	13,8255	0,1383	1	12	192
1 in.lb =	11,2985	1,1298	0,1130	1,1521	0,0115	0,0833	1	16
1 in. oz =	0,7062	0,0706	0,0071	0,0720	0,0007	0,0052	0,0625	1

**Example 1**  
 1 Nm = 0,102 mkg  
 17,4 Nm = 17,4 x 0,102 mkg  
 17,4 Nm = 1,775 mkg

**Example 2**  
 1 mkg = 9,8067 Nm  
 12,5 mkg = 12,5 x 9,8067 Nm  
 12,5 mkg = 122,58 Nm

## Conversion Nm in mkg 1 Nm = 0,10197 mkg

Nm	0	1	2	3	4	5	6	7	8	9
0	0,00	0,10	0,20	0,31	0,41	0,51	0,61	0,71	0,82	0,92
10	1,02	1,12	1,22	1,33	1,43	1,53	1,63	1,73	1,84	1,94
20	2,04	2,14	2,24	2,35	2,45	2,55	2,65	2,75	2,86	2,96
30	3,06	3,16	3,26	3,37	3,47	3,57	3,67	3,77	3,87	3,98
40	4,08	4,18	4,28	4,38	4,49	4,59	4,69	4,79	4,89	5,00
50	5,10	5,20	5,30	5,40	5,51	5,61	5,71	5,81	5,91	6,02
60	6,12	6,22	6,32	6,42	6,53	6,63	6,73	6,83	6,93	7,04
70	7,14	7,24	7,34	7,44	7,55	7,65	7,75	7,85	7,95	8,06
80	8,16	8,26	8,36	8,46	8,57	8,67	8,77	8,87	8,97	9,08
90	9,18	9,28	9,38	9,48	9,59	9,69	9,79	9,89	9,99	10,10
100	10,20	10,30	10,40	10,50	10,60	10,71	10,81	10,91	11,01	11,11

## Conversion mkg in Nm 1 mkg = 9,80665 Nm

mkg	0	1	2	3	4	5	6	7	8	9
0	0,00	9,81	19,61	29,42	39,23	49,03	58,84	68,65	78,45	88,26
10	98,07	107,87	117,68	127,49	137,29	147,10	156,91	166,71	176,52	186,33
20	196,13	205,94	215,75	225,55	235,36	245,17	254,97	264,78	274,59	284,39
30	294,20	304,01	313,81	323,62	333,43	343,23	353,04	362,85	372,65	382,46
40	392,27	402,07	411,88	421,69	431,49	441,30	451,11	460,91	470,72	480,53
50	490,33	500,14	509,95	519,75	529,56	539,37	549,17	558,98	568,79	578,59
60	588,40	598,21	608,01	617,82	627,63	637,43	647,24	657,05	666,85	676,66
70	686,47	696,27	706,08	715,89	725,69	735,50	745,31	755,11	764,92	774,73
80	784,53	794,34	804,15	813,95	823,76	833,57	843,37	853,18	862,99	872,79
90	882,60	892,41	902,21	912,02	921,83	931,63	941,44	951,25	961,05	970,86
100	980,67	990,47	1000,28	1010,08	1019,89	1029,70	1039,50	1049,31	1059,12	1068,92

## Conversion Nm in ft.lb 1 Nm = 0,73756 ft.lb

Nm	0	1	2	3	4	5	6	7	8	9
0	0,00	0,74	1,48	2,21	2,95	3,69	4,43	5,16	5,90	6,64
10	7,38	8,11	8,85	9,59	10,33	11,06	11,80	12,54	13,28	14,01
20	14,75	15,49	16,23	16,96	17,70	18,44	19,18	19,91	20,65	21,39
30	22,13	22,86	23,60	24,34	25,08	25,81	26,55	27,29	28,03	28,76
40	29,50	30,24	30,98	31,72	32,45	33,19	33,93	34,67	35,40	36,14
50	36,88	37,62	38,35	39,09	39,83	40,57	41,30	42,04	42,78	43,52
60	44,25	44,99	45,73	46,47	47,20	47,94	48,68	49,42	50,15	50,89
70	51,63	52,37	53,10	53,84	54,58	55,32	56,05	56,79	57,53	58,27
80	59,00	59,74	60,48	61,22	61,96	62,69	63,43	64,17	64,91	65,64
90	66,38	67,12	67,86	68,59	69,33	70,07	70,81	71,54	72,28	73,02
100	73,76	74,49	75,23	75,97	76,71	77,44	78,18	78,92	79,66	80,39

## Conversion ft.lb in Nm 1 ft.lb = 1,35581 Nm

ft.lb	0	1	2	3	4	5	6	7	8	9
0	0,00	1,36	2,71	4,07	5,42	6,78	8,13	9,49	10,85	12,20
10	13,56	14,91	16,27	17,63	18,98	20,34	21,69	23,05	24,40	25,76
20	27,12	28,47	29,83	31,18	32,54	33,90	35,25	36,61	37,96	39,32
30	40,67	42,03	43,39	44,74	46,10	47,45	48,81	50,16	51,52	52,88
40	54,23	55,59	56,94	58,30	59,66	61,01	62,37	63,72	65,08	66,43
50	67,79	69,15	70,50	71,86	73,21	74,57	75,93	77,28	78,64	79,99
60	81,35	82,70	84,06	85,42	86,77	88,13	89,48	90,84	92,20	93,55
70	94,91	96,26	97,62	98,97	100,33	101,69	103,04	104,40	105,75	107,11
80	108,46	109,82	111,18	112,53	113,89	115,24	116,60	117,96	119,31	120,67
90	122,02	123,38	124,73	126,09	127,45	128,80	130,16	131,51	132,87	134,23
100	135,58	136,94	138,29	139,65	141,00	142,36	143,72	145,07	146,43	147,78

## Conversion Nm in in.lb 1 Nm = 8,85077 in.lb

Nm	0	1	2	3	4	5	6	7	8	9
0	0,00	8,85	17,70	26,55	35,40	44,25	53,10	61,96	70,81	79,66
10	88,51	97,36	106,21	115,06	123,91	132,76	141,61	150,46	159,31	168,16
20	177,02	185,87	194,72	203,57	212,42	221,27	230,12	238,97	247,82	256,67
30	265,52	274,37	283,22	292,08	300,93	309,78	318,63	327,48	336,33	345,18
40	354,03	362,88	371,73	380,58	389,43	398,28	407,14	415,99	424,84	433,69
50	442,54	451,39	460,24	469,09	477,94	486,79	495,64	504,49	513,34	522,20
60	531,05	539,90	548,75	557,60	566,45	575,30	584,15	593,00	601,85	610,70
70	619,55	628,40	637,26	646,11	654,96	663,81	672,66	681,51	690,36	699,21
80	708,06	716,91	725,76	734,61	743,46	752,32	761,17	770,02	778,87	787,72
90	796,57	805,42	814,27	823,12	831,97	840,82	849,67	858,52	867,38	876,23
100	885,08	893,93	902,78	911,63	920,48	929,33	938,18	947,03	955,88	964,73

## Conversion in.lb in Nm 1 in.lb = 0,11298 Nm

in.lb	0	1	2	3	4	5	6	7	8	9
0	0,00	0,11	0,23	0,34	0,45	0,56	0,68	0,79	0,90	1,02
10	1,13	1,24	1,36	1,47	1,58	1,69	1,81	1,92	2,03	2,15
20	2,26	2,37	2,49	2,60	2,71	2,82	2,94	3,05	3,16	3,28
30	3,39	3,50	3,62	3,73	3,84	3,95	4,07	4,18	4,29	4,41
40	4,52	4,63	4,75	4,86	4,97	5,08	5,20	5,31	5,42	5,54
50	5,65	5,76	5,87	5,99	6,10	6,21	6,33	6,44	6,55	6,67
60	6,78	6,89	7,00	7,12	7,23	7,34	7,46	7,57	7,68	7,80
70	7,91	8,02	8,13	8,25	8,36	8,47	8,59	8,70	8,81	8,93
80	9,04	9,15	9,26	9,38	9,49	9,60	9,72	9,83	9,94	10,06
90	10,17	10,28	10,39	10,51	10,62	10,73	10,85	10,96	11,07	11,19
100	11,30	11,41	11,52	11,64	11,75	11,86	11,98	12,09	12,20	12,31

# Conversion Of Inches To Millimeters

Inches		0	1	2	3	4	5	6	7	8	9
			25.400	50.800	76.200	101.600	127.000	152.400	177.800	203.200	228.600
$\frac{1}{64}$	0.015625	0.397	25.797	51.197	76.597	101.997	127.397	152.797	178.197	203.597	228.997
$\frac{1}{32}$	0.03125	0.794	26.194	51.594	76.994	102.394	127.794	153.194	178.594	203.994	229.394
$\frac{3}{64}$	0.046875	1.191	26.591	51.991	77.391	102.791	128.191	153.591	178.991	204.391	229.791
$\frac{1}{16}$	0.0625	1.588	26.988	52.388	77.788	103.188	128.588	153.988	179.388	204.788	230.188
$\frac{5}{64}$	0.078125	1.984	27.384	52.784	78.184	103.584	128.984	154.384	179.784	205.184	230.584
$\frac{3}{32}$	0.09375	2.381	27.781	53.181	78.581	103.981	129.381	154.781	180.181	205.581	230.981
$\frac{7}{64}$	0.109375	2.778	28.178	53.578	78.978	104.378	129.778	155.178	180.578	205.978	231.378
$\frac{1}{8}$	0.125	3.175	28.575	53.975	79.375	104.775	130.175	155.575	180.975	206.375	231.775
$\frac{9}{64}$	0.140625	3.572	28.972	54.372	79.772	105.172	130.572	155.972	181.372	206.772	232.172
$\frac{5}{32}$	0.15625	3.969	29.369	54.769	80.169	105.569	130.969	156.369	181.769	207.169	232.569
$\frac{11}{64}$	0.171875	4.366	29.766	55.166	80.566	105.966	131.366	156.766	182.166	207.566	232.966
$\frac{3}{16}$	0.1875	4.762	30.162	55.562	80.962	106.362	131.762	157.162	182.562	207.962	233.362
$\frac{13}{64}$	0.203125	5.159	30.559	55.959	81.359	106.759	132.159	157.559	182.959	208.359	233.759
$\frac{7}{32}$	0.21875	5.556	30.956	56.356	81.756	107.156	132.556	157.956	183.356	208.756	234.156
$\frac{15}{64}$	0.234375	5.953	31.353	56.753	82.153	107.553	132.953	158.353	183.753	209.153	234.553
$\frac{1}{4}$	0.25	6.350	31.750	57.150	82.550	107.950	133.350	158.750	184.150	209.550	234.950
$\frac{17}{64}$	0.265625	6.747	32.147	57.547	82.947	108.347	133.747	159.147	184.547	209.947	235.347
$\frac{9}{32}$	0.28125	7.144	32.544	57.944	83.344	108.744	134.144	159.544	184.944	210.344	235.744
$\frac{19}{64}$	0.296875	7.541	32.941	58.341	83.741	109.141	134.541	159.941	185.341	210.741	236.141
$\frac{5}{16}$	0.3125	7.938	33.338	58.738	84.138	109.538	134.938	160.338	185.738	211.138	236.538
$\frac{21}{64}$	0.328125	8.334	33.734	59.134	84.534	109.934	135.334	160.734	186.134	211.534	236.934
$\frac{11}{32}$	0.34375	8.731	34.131	59.531	84.931	110.331	135.731	161.131	186.531	211.931	237.331
$\frac{23}{64}$	0.359375	9.128	34.528	59.928	85.328	110.728	136.128	161.528	186.928	212.328	237.728
$\frac{3}{8}$	0.375	9.525	34.925	60.325	85.725	111.125	136.525	161.925	187.325	212.725	238.125
$\frac{25}{64}$	0.390625	9.922	35.322	60.722	86.122	111.522	136.922	162.322	187.722	213.122	238.522
$\frac{13}{32}$	0.40625	10.319	35.719	61.119	86.519	111.919	137.319	162.719	188.119	213.519	238.919
$\frac{27}{64}$	0.421875	10.716	36.116	61.516	86.916	112.316	137.716	163.116	188.516	213.916	239.316
$\frac{7}{16}$	0.4375	11.112	36.512	61.912	87.312	112.712	138.112	163.512	188.912	214.312	239.712
$\frac{29}{64}$	0.453125	11.509	36.909	62.309	87.709	113.109	138.509	163.909	189.309	214.709	240.109
$\frac{15}{32}$	0.46875	11.906	37.306	62.706	88.106	113.506	138.906	164.306	189.706	215.106	240.506
$\frac{31}{64}$	0.484375	12.303	37.703	63.103	88.503	113.903	139.303	164.703	190.103	215.503	240.903
$\frac{1}{2}$	0.5	12.700	38.100	63.500	88.900	114.300	139.700	165.100	190.500	215.900	241.300
$\frac{33}{64}$	0.515625	13.097	38.497	63.897	89.297	114.697	140.097	165.497	190.897	216.297	241.697
$\frac{17}{32}$	0.53125	13.494	38.894	64.294	89.694	115.094	140.494	165.894	191.294	216.694	242.094
$\frac{35}{64}$	0.546875	13.891	39.291	64.691	90.091	115.491	140.891	166.291	191.691	217.091	242.491
$\frac{9}{16}$	0.5625	14.288	39.688	65.088	90.488	115.888	141.288	166.688	192.088	217.488	242.888
$\frac{37}{64}$	0.578125	14.684	40.084	65.484	90.884	116.284	141.684	167.084	192.484	217.884	243.284
$\frac{19}{32}$	0.59375	15.081	40.481	65.881	91.281	116.681	142.081	167.481	192.881	218.281	243.681
$\frac{39}{64}$	0.609375	15.478	40.878	66.278	91.678	117.078	142.478	167.878	193.278	218.678	244.078
$\frac{5}{8}$	0.625	15.875	41.275	66.675	92.075	117.475	142.875	168.275	193.675	219.075	244.475
$\frac{41}{64}$	0.640625	16.272	41.672	67.072	92.472	117.872	143.272	168.672	194.072	219.472	244.872
$\frac{21}{32}$	0.65625	16.669	42.069	67.469	92.869	118.269	143.669	169.069	194.469	219.869	245.269
$\frac{43}{64}$	0.671875	17.066	42.466	67.866	93.266	118.666	144.066	169.466	194.866	220.266	245.666
$\frac{11}{16}$	0.6875	17.462	42.862	68.262	93.662	119.062	144.462	169.862	195.262	220.662	246.062
$\frac{45}{64}$	0.703125	17.859	43.259	68.659	94.059	119.459	144.859	170.259	195.659	221.059	246.459
$\frac{23}{32}$	0.71875	18.256	43.656	69.056	94.456	119.856	145.256	170.656	196.056	221.456	246.856
$\frac{47}{64}$	0.734375	18.653	44.053	69.453	94.853	120.253	145.653	171.053	196.453	221.853	247.253
$\frac{3}{4}$	0.75	19.050	44.450	69.850	95.250	120.650	146.050	171.450	196.850	222.250	247.650
$\frac{49}{64}$	0.765625	19.447	44.847	70.247	95.647	121.047	146.447	171.847	197.247	222.647	248.047
$\frac{25}{32}$	0.78125	19.844	45.244	70.644	96.044	121.444	146.844	172.244	197.644	223.044	248.444
$\frac{51}{64}$	0.796875	20.241	45.641	71.041	96.441	121.841	147.241	172.641	198.041	223.441	248.841
$\frac{13}{16}$	0.8125	20.638	46.038	71.438	96.838	122.238	147.638	173.038	198.438	223.838	249.238
$\frac{53}{64}$	0.828125	21.034	46.434	71.834	97.234	122.634	148.034	173.434	198.834	224.234	249.634
$\frac{27}{32}$	0.84375	21.431	46.831	72.231	97.631	123.031	148.431	173.831	199.231	224.631	250.031
$\frac{55}{64}$	0.859375	21.828	47.228	72.628	98.028	123.428	148.828	174.228	199.628	225.028	250.428
$\frac{7}{8}$	0.875	22.225	47.625	73.025	98.425	123.825	149.225	174.625	200.025	225.425	250.825
$\frac{57}{64}$	0.890625	22.622	48.022	73.422	98.822	124.222	149.622	175.022	200.422	225.822	251.222
$\frac{29}{32}$	0.90625	23.019	48.419	73.819	99.219	124.619	150.019	175.419	200.819	226.219	251.619
$\frac{59}{64}$	0.921875	23.416	48.816	74.216	99.616	125.016	150.416	175.816	201.216	226.616	252.016
$\frac{15}{16}$	0.9375	23.812	49.212	74.612	100.012	125.412	150.812	176.212	201.612	227.012	252.412
$\frac{61}{64}$	0.953125	24.209	49.609	75.009	100.409	125.809	151.209	176.609	202.009	227.409	252.809
$\frac{31}{32}$	0.96875	24.606	50.006	75.406	100.806	126.206	151.606	177.006	202.406	227.806	253.206
$\frac{63}{64}$	0.984375	25.003	50.403	75.803	101.203	126.603	152.003	177.403	202.803	228.203	253.603

Values in mm

# Code No. Index

Code No.	Page	Code No.	Page	Code No.	Page	Code No.	Page				
05 002900	001	254	05 003080	001	130	05 003386	001	108	05 003564	001	122
05 002901	001	251	05 003081	001	130	05 003387	001	108	05 003565	001	122
05 002910	001	255	05 003082	001	130	05 003388	001	108	05 003566	001	122
05 002913	001	255	05 003083	001	130	05 003389	001	108	05 003567	001	122
05 002920	001	255	05 003084	001	130	05 003390	001	106	05 003568	001	122
05 002923	001	255	05 003085	001	130	05 003391	001	106	05 003569	001	122
05 002926	001	255	05 003086	001	130	05 003392	001	106	05 003570	001	122
05 002930	001	255	05 003087	001	130	05 003393	001	106	05 003571	001	122
05 002933	001	255	05 003088	001	130	05 003460	001	84	05 003572	001	122
05 002936	001	255	05 003089	001	130	05 003461	001	84	05 003573	001	122
05 002938	001	255	05 003090	001	130	05 003462	001	84	05 003574	001	122
05 002940	001	255	05 003091	001	130	05 003463	001	84	05 003575	001	122
05 002943	001	255	05 003092	001	130	05 003499	001	102	05 003576	001	122
05 002946	001	255	05 003093	001	130	05 003500	001	98	05 003577	001	122
05 002948	001	255	05 003094	001	130	05 003501	001	102	05 003578	001	122
05 002950	001	255	05 003180	001	131	05 003502	001	102	05 003579	001	122
05 002960	001	255	05 003181	001	132	05 003503	001	102	05 003580	001	122
05 002966	001	255	05 003185	001	129	05 003504	001	102	05 003581	001	134
05 002968	001	255	05 003210	001	254	05 003505	001	102	05 003582	001	134
05 002970	001	255	05 003320	001	109	05 003506	001	102	05 003583	001	134
05 002973	001	255	05 003321	001	109	05 003507	001	102	05 003584	001	134
05 002976	001	255	05 003322	001	109	05 003508	001	102	05 003585	001	134
05 002980	001	255	05 003330	001	108	05 003509	001	102	05 003590	001	134
05 002990	001	253	05 003331	001	108	05 003510	001	102	05 003591	001	133
05 003010	001	102	05 003332	001	108	05 003511	001	102	05 003592	001	133
05 003030	001	130	05 003333	001	108	05 003512	001	102	05 003594	001	114
05 003031	001	130	05 003334	001	108	05 003513	001	102	05 003596	001	114
05 003032	001	130	05 003335	001	108	05 003514	001	102	05 003600	001	138
05 003033	001	130	05 003336	001	108	05 003515	001	102	05 003601	001	145
05 003034	001	130	05 003337	001	108	05 003516	001	102	05 003602	001	145
05 003035	001	130	05 003338	001	108	05 003517	001	102	05 003603	001	145
05 003036	001	130	05 003339	001	108	05 003518	001	102	05 003604	001	145
05 003037	001	130	05 003340	001	108	05 003519	001	102	05 003605	001	145
05 003038	001	130	05 003341	001	108	05 003520	001	102	05 003606	001	145
05 003039	001	130	05 003342	001	108	05 003521	001	102	05 003607	001	145
05 003040	001	130	05 003345	001	109	05 003522	001	102	05 003608	001	145
05 003041	001	130	05 003350	001	109	05 003523	001	102	05 003609	001	145
05 003042	001	130	05 003351	001	109	05 003524	001	110	05 003610	001	145
05 003043	001	130	05 003352	001	109	05 003525	001	110	05 003611	001	145
05 003044	001	130	05 003353	001	109	05 003526	001	110	05 003612	001	145
05 003050	001	130	05 003354	001	109	05 003527	001	111	05 003613	001	145
05 003051	001	130	05 003355	001	109	05 003528	001	110	05 003614	001	145
05 003052	001	130	05 003360	001	106	05 003529	001	111	05 003615	001	145
05 003054	001	130	05 003361	001	106	05 003530	001	110	05 003616	001	145
05 003056	001	130	05 003362	001	106	05 003531	001	109	05 003617	001	145
05 003059	001	128	05 003363	001	106	05 003533	001	96	05 003618	001	145
05 003060	001	128	05 003364	001	106	05 003535	001	97	05 003619	001	145
05 003061	001	128	05 003365	001	106	05 003536	001	112	05 003620	001	145
05 003062	001	128	05 003366	001	106	05 003550	001	115	05 003621	001	145
05 003063	001	128	05 003367	001	106	05 003551	001	122	05 003622	001	145
05 003064	001	128	05 003368	001	106	05 003552	001	122	05 003623	001	145
05 003065	001	128	05 003369	001	106	05 003553	001	122	05 003624	001	145
05 003066	001	128	05 003370	001	106	05 003554	001	122	05 003625	001	145
05 003067	001	128	05 003371	001	106	05 003555	001	122	05 003626	001	145
05 003068	001	128	05 003372	001	106	05 003556	001	122	05 003627	001	145
05 003069	001	128	05 003375	001	107	05 003557	001	122	05 003628	001	145
05 003070	001	128	05 003380	001	108	05 003558	001	122	05 003629	001	145
05 003071	001	128	05 003381	001	108	05 003559	001	122	05 003630	001	145
05 003072	001	128	05 003382	001	108	05 003560	001	122	05 003631	001	145
05 003073	001	128	05 003383	001	108	05 003561	001	122	05 003632	001	145
05 003074	001	128	05 003384	001	108	05 003562	001	122	05 003633	001	145
05 003075	001	128	05 003385	001	108	05 003563	001	122	05 003634	001	145

# Code No. Index

Code No.	Page	Code No.	Page	Code No.	Page	Code No.	Page
05 003635	001 145	05 003753	001 123	05 003995	001 146	05 004351	001 280
05 003636	001 155	05 003755	001 94	05 003996	001 153	05 004352	001 277
05 003637	001 155	05 003756	001 101	05 003997	001 150	05 004353	001 277
05 003638	001 154	05 003760	001 181	05 004003	001 100	05 004354	001 277
05 003639	001 155	05 003765	001 181	05 004004	001 101	05 004355	001 278
05 003640	001 155	05 003780	001 139	05 004016	001 95	05 004356	001 278
05 003641	001 155	05 003781	001 140	05 004017	001 99	05 004357	001 277
05 003642	001 154	05 003785	001 121	05 004018	001 100	05 004500	001 105
05 003643	001 154	05 003793	001 173	05 004019	001 95	05 004501	001 105
05 003645	001 137	05 003820	001 152	05 004020	001 99	05 004502	001 105
05 003647	001 138	05 003821	001 152	05 004021	001 101	05 004503	001 105
05 003660	001 172	05 003822	001 152	05 004033	001 119	05 004504	001 105
05 003665	001 173	05 003823	001 152	05 004034	001 121	05 004505	001 105
05 003666	001 173	05 003824	001 152	05 004046	001 113	05 004506	001 105
05 003667	001 173	05 003825	001 152	05 004047	001 118	05 004507	001 105
05 003668	001 173	05 003826	001 152	05 004048	001 120	05 004508	001 105
05 003669	001 173	05 003827	001 152	05 004049	001 113	05 004509	001 105
05 003670	001 173	05 003828	001 152	05 004050	001 119	05 004510	001 105
05 003675	001 173	05 003829	001 152	05 004051	001 121	05 004511	001 105
05 003684	001 173	05 003830	001 150	05 004063	001 141	05 004512	001 105
05 003685	001 173	05 003831	001 150	05 004064	001 142	05 004525	001 105
05 003690	001 173	05 003832	001 150	05 004076	001 136	05 004530	001 126
05 003692	001 160	05 003833	001 150	05 004077	001 140	05 004531	001 126
05 003695	001 161	05 003834	001 150	05 004078	001 141	05 004532	001 126
05 003696	001 161	05 003835	001 150	05 004079	001 137	05 004533	001 126
05 003697	001 161	05 003836	001 150	05 004080	001 141	05 004534	001 126
05 003717	001 102	05 003837	001 150	05 004081	001 142	05 004535	001 126
05 003718	001 102	05 003838	001 150	05 004090	001 139	05 004536	001 126
05 003719	001 102	05 003840	001 152	05 004095	001 139	05 004537	001 126
05 003720	001 102	05 003841	001 152	05 004170	001 168	05 004538	001 126
05 003721	001 102	05 003842	001 152	05 004171	001 225	05 004539	001 126
05 003722	001 102	05 003843	001 152	05 004172	001 169	05 004540	001 126
05 003723	001 102	05 003844	001 152	05 004173	001 200	05 004541	001 126
05 003724	001 102	05 003845	001 152	05 004174	001 46	05 004542	001 126
05 003725	001 102	05 003850	001 150	05 004175	001 115	05 004543	001 126
05 003726	001 102	05 003851	001 150	05 004176	001 133	05 004544	001 126
05 003727	001 102	05 003852	001 150	05 004177	001 171	05 004545	001 127
05 003728	001 102	05 003853	001 150	05 004178	001 184	05 004550	001 148
05 003729	001 102	05 003854	001 150	05 004179	001 239	05 004551	001 148
05 003730	001 145	05 003855	001 150	05 004180	001 400	05 004552	001 148
05 003731	001 145	05 003856	001 150	05 004181	001 184	05 004553	001 148
05 003732	001 145	05 003857	001 150	05 004182	001 31	05 004554	001 148
05 003733	001 145	05 003858	001 150	05 004183	001 170	05 004555	001 148
05 003734	001 145	05 003880	001 103	05 004184	001 31	05 004556	001 148
05 003735	001 145	05 003881	001 108	05 004185	001 239	05 004557	001 148
05 003736	001 145	05 003882	001 107	05 004190	001 28	05 004558	001 148
05 003737	001 145	05 003883	001 103	05 004201	001 153	05 004559	001 148
05 003738	001 145	05 003884	001 104	05 004202	001 151	05 004560	001 148
05 003739	001 145	05 003890	001 111	05 004203	001 147	05 004561	001 148
05 003740	001 123	05 003891	001 111	05 004210	001 153	05 004562	001 148
05 003741	001 123	05 003892	001 161	05 004211	001 151	05 004563	001 148
05 003742	001 123	05 003893	001 162	05 004212	001 152	05 004565	001 149
05 003743	001 123	05 003970	001 124	05 004280	001 156	05 004570	001 142
05 003744	001 123	05 003971	001 131	05 004281	001 157	05 004571	001 142
05 003745	001 123	05 003972	001 129	05 004282	001 156	05 004572	001 142
05 003746	001 123	05 003973	001 125	05 004283	001 158	05 004573	001 142
05 003747	001 123	05 003974	001 132	05 004284	001 159	05 004574	001 142
05 003748	001 123	05 003980	001 135	05 004285	001 159	05 004575	001 142
05 003749	001 123	05 003981	001 135	05 004310	001 63	05 004576	001 142
05 003750	001 123	05 003982	001 89	05 004313	001 22	05 004577	001 142
05 003751	001 123	05 003990	001 78	05 004350	001 276	05 004578	001 142
05 003752	001 123	05 003991	001 66	05 004351	001 276	05 004580	001 143



Code No.	Page	Code No.	Page	Code No.	Page	Code No.	Page				
05 004590	001	147	05 005310	001	62	05 006145	001	63	05 006516	001	81
05 004591	001	147	05 005315	001	62	05 006147	001	63	05 006517	001	81
05 004592	001	147	05 005320	001	62	05 006148	001	63	05 006518	001	83
05 004595	001	148	05 005325	001	62	05 006150	001	59	05 006519	001	83
05 004780	001	61	05 005330	001	62	05 006152	001	59	05 006520	001	83
05 004781	001	61	05 005335	001	62	05 006153	001	59	05 006521	001	83
05 004782	001	61	05 005340	001	62	05 006154	001	59	05 006522	001	83
05 004783	001	61	05 005400	001	104	05 006156	001	59	05 006523	001	80
05 004784	001	61	05 005410	001	106	05 006158	001	59	05 006524	001	80
05 004830	001	144	05 005420	001	104	05 006159	001	59	05 006525	001	80
05 004831	001	144	05 005430	001	125	05 006160	001	59	05 006526	001	81
05 004832	001	144	05 005440	001	127	05 006162	001	59	05 006527	001	81
05 004833	001	144	05 005450	001	126	05 006163	001	59	05 006528	001	81
05 004834	001	144	05 005451	001	123	05 006164	001	59	05 006529	001	81
05 004835	001	144	05 005452	001	124	05 006165	001	59	05 006530	001	82
05 004836	001	144	05 005460	001	151	05 006166	001	59	05 006531	001	82
05 004837	001	144	05 005470	001	149	05 006168	001	59	05 006532	001	82
05 004838	001	144	05 005480	001	146	05 006169	001	61	05 006533	001	82
05 004839	001	144	05 005490	001	143	05 006170	001	61	05 006534	001	82
05 004840	001	144	05 005500	001	122	05 006172	001	61	05 006535	001	82
05 004841	001	144	05 005501	001	122	05 006174	001	61	05 006536	001	82
05 004900	001	88	05 005502	001	122	05 006176	001	61	05 006537	001	82
05 004901	001	88	05 005503	001	122	05 006177	001	61	05 006538	001	82
05 004902	001	88	05 005504	001	122	05 006178	001	61	05 006539	001	82
05 004903	001	88	05 005505	001	122	05 006179	001	61	05 006540	001	83
05 004920	001	88	05 005506	001	122	05 006181	001	61	05 006541	001	83
05 004921	001	88	05 005507	001	122	05 006182	001	61	05 006542	001	83
05 004922	001	88	05 005508	001	122	05 006183	001	61	05 006543	001	83
05 004923	001	88	05 005509	001	122	05 006184	001	61	05 006544	001	83
05 004924	001	88	05 005510	001	122	05 006190	001	60	05 006545	001	83
05 004925	001	88	05 005511	001	122	05 006191	001	60	05 006546	001	83
05 004930	001	87	05 005512	001	122	05 006380	001	60	05 006550	001	79
05 004940	001	88	05 005513	001	122	05 006381	001	60	05 006551	001	79
05 004941	001	88	05 005514	001	122	05 006440	001	58	05 006552	001	79
05 004942	001	88	05 005515	001	122	05 006441	001	58	05 006553	001	79
05 004950	001	88	05 005516	001	122	05 006442	001	58	05 006554	001	79
05 004951	001	88	05 005517	001	122	05 006450	001	59	05 006555	001	79
05 004952	001	88	05 005518	001	122	05 006451	001	59	05 006556	001	80
05 004953	001	88	05 005519	001	122	05 006455	001	60	05 006557	001	80
05 004954	001	88	05 005520	001	122	05 006456	001	60	05 006558	001	80
05 004955	001	88	05 005521	001	122	05 006460	001	60	05 006559	001	80
05 004956	001	88	05 005522	001	122	05 006461	001	60	05 006560	001	80
05 004957	001	88	05 005523	001	122	05 006465	001	61	05 006561	001	83
05 004958	001	88	05 005524	001	122	05 006466	001	61	05 006562	001	83
05 004959	001	88	05 005525	001	122	05 006470	001	65	05 006563	001	83
05 004960	001	88	05 005526	001	122	05 006480	001	64	05 006564	001	83
05 004961	001	88	05 005530	001	116	05 006500	001	79	05 006565	001	83
05 004962	001	88	05 005531	001	117	05 006501	001	79	05 006566	001	81
05 004963	001	88	05 005540	001	117	05 006502	001	79	05 006567	001	81
05 004964	001	89	05 005655	001	62	05 006503	001	79	05 006568	001	82
05 004965	001	89	05 006100	001	58	05 006504	001	79	05 006569	001	82
05 004966	001	87	05 006105	001	58	05 006505	001	79	05 006570	001	82
05 004970	001	86	05 006110	001	58	05 006506	001	80	05 006571	001	82
05 004980	001	91	05 006115	001	58	05 006507	001	80	05 006572	001	82
05 004981	001	91	05 006116	001	58	05 006508	001	80	05 006573	001	82
05 005080	001	394	05 006120	001	58	05 006509	001	80	05 006574	001	82
05 005081	001	394	05 006121	001	58	05 006510	001	80	05 006575	001	67
05 005090	001	394	05 006125	001	58	05 006511	001	80	05 006576	001	67
05 005091	001	394	05 006126	001	58	05 006512	001	80	05 006577	001	67
05 005120	001	86	05 006130	001	58	05 006513	001	80	05 006578	001	67
05 005300	001	62	05 006135	001	58	05 006514	001	81	05 006579	001	67
05 005305	001	62	05 006140	001	58	05 006515	001	81	05 006580	001	67

# Code No. Index

Code No.	Page	Code No.	Page	Code No.	Page	Code No.	Page
05 006581	001 67	05 008712	001 13	05 017015	001 9	05 020070	001 179
05 006582	001 68	05 008715	001 13	05 017020	001 9	05 020071	001 179
05 006583	001 68	05 008720	001 13	05 017040	001 9	05 020072	001 179
05 006584	001 68	05 008723	001 13	05 017041	001 9	05 020073	001 179
05 006585	001 68	05 008725	001 13	05 017050	001 9	05 020074	001 179
05 006586	001 69	05 008730	001 13	05 017052	001 9	05 020075	001 179
05 006587	001 69	05 008735	001 13	05 017054	001 9	05 020076	001 179
05 006588	001 69	05 008740	001 13	05 017056	001 9	05 020077	001 179
05 006589	001 69	05 008750	001 13	05 018100	001 232	05 020078	001 179
05 006590	001 68	05 008751	001 13	05 018110	001 231	05 020079	001 179
05 006591	001 68	05 008752	001 13	05 018111	001 231	05 020080	001 179
05 006592	001 68	05 008753	001 13	05 018140	001 233	05 020081	001 179
05 006600	001 77	05 008840	001 19	05 018141	001 233	05 020082	001 179
05 006601	001 77	05 008841	001 19	05 018142	001 233	05 020090	001 180
05 006603	001 76	05 008842	001 19	05 018150	001 233	05 020091	001 180
05 006604	001 77	05 008843	001 19	05 018151	001 233	05 020092	001 180
05 006605	001 71	05 008844	001 19	05 018152	001 233	05 020093	001 180
05 006607	001 76	05 008850	001 20	05 018153	001 233	05 020099	001 187
05 006608	001 75	05 008851	001 20	05 018154	001 233	05 020100	001 187
05 006609	001 71	05 008852	001 20	05 018155	001 233	05 020101	001 188
05 006611	001 75	05 008853	001 20	05 018156	001 233	05 020102	001 188
05 006612	001 74	05 008854	001 20	05 018157	001 233	05 020103	001 187
05 006613	001 73	05 008855	001 20	05 018160	001 232	05 020104	001 188
05 006614	001 74	05 008856	001 20	05 018161	001 232	05 020110	001 188
05 006616	001 73	05 008857	001 20	05 018162	001 232	05 020129	001 58
05 006617	001 72	05 008858	001 20	05 018163	001 232	05 020131	001 59
05 006618	001 70	05 008859	001 20	05 018164	001 232	05 020132	001 61
05 006619	001 70	05 008860	001 20	05 018165	001 232	05 020133	001 59
05 006630	001 66	05 008861	001 20	05 018166	001 232	05 020134	001 61
05 006631	001 65	05 008862	001 20	05 018167	001 232	05 020150	001 90
05 006640	001 78	05 008863	001 20	05 018168	001 232	05 020151	001 91
05 006641	001 79	05 008864	001 20	05 018169	001 232	05 020152	001 91
05 007610	001 12	05 008870	001 27	05 018170	001 232	05 020153	001 91
05 007620	001 12	05 008871	001 27	05 018171	001 233	05 020170	001 90
05 007621	001 12	05 008872	001 27	05 018172	001 233	05 020171	001 414
05 007635	001 12	05 008873	001 237	05 018173	001 233	05 020172	001 413
05 007640	001 12	05 008874	001 237	05 018260	001 8	05 020173	001 413
05 007670	001 12	05 008875	001 237	05 018262	001 8	05 020190	001 181
05 007671	001 12	05 008876	001 27	05 018264	001 8	05 020198	001 181
05 007672	001 12	05 008877	001 237	05 018266	001 8	05 020199	001 181
05 007673	001 12	05 008878	001 237	05 018268	001 8	05 020200	001 181
05 007674	001 12	05 008880	001 250	05 018270	001 8	05 020201	001 181
05 007675	001 12	05 008881	001 55	05 018272	001 8	05 020202	001 181
05 007676	001 12	05 008882	001 55	05 018274	001 8	05 020203	001 181
05 007677	001 12	05 008883	001 236	05 018282	001 10	05 020204	001 181
05 007680	001 22	05 008884	001 236	05 018283	001 10	05 020205	001 181
05 007681	001 23	05 008886	001 236	05 018287	001 10	05 020206	001 181
05 008006	001 11	05 009305	001 14	05 018300	001 8	05 020207	001 181
05 008007	001 11	05 009310	001 14	05 018301	001 8	05 020208	001 181
05 008008	001 11	05 009312	001 14	05 018302	001 8	05 020209	001 181
05 008009	001 11	05 009313	001 14	05 020012	001 178	05 020210	001 181
05 008015	001 11	05 009315	001 14	05 020013	001 178	05 020211	001 181
05 008027	001 11	05 009317	001 14	05 020014	001 177	05 020212	001 181
05 008055	001 11	05 009319	001 14	05 020015	001 177	05 020213	001 181
05 008060	001 11	05 009320	001 14	05 020016	001 177	05 020214	001 181
05 008061	001 11	05 009325	001 14	05 020022	001 178	05 020215	001 181
05 008100	001 26	05 009340	001 13	05 020064	001 179	05 020216	001 181
05 008101	001 18	05 009341	001 13	05 020065	001 179	05 020217	001 181
05 008102	001 18	05 009342	001 13	05 020066	001 179	05 020218	001 181
05 008705	001 13	05 009343	001 13	05 020067	001 179	05 020219	001 181
05 008706	001 13	05 017005	001 9	05 020068	001 179	05 020220	001 181
05 008710	001 13	05 017010	001 9	05 020069	001 179	05 020221	001 182

Code No.	Page	Code No.	Page	Code No.	Page	Code No.	Page
05 020228	001 185	05 021728	001 199	05 022604	001 203	05 022698	001 201
05 020229	001 186	05 021737	001 197	05 022606	001 203	05 022699	001 192
05 020230	001 183	05 021909	001 196	05 022608	001 203	05 022700	001 202
05 020231	001 183	05 021909	001 280	05 022610	001 203	05 022701	001 202
05 020232	001 182	05 022040	001 204	05 022612	001 203	05 022702	001 202
05 020233	001 186	05 022041	001 204	05 022614	001 203	05 022703	001 202
05 020234	001 186	05 022042	001 204	05 022616	001 203	05 022704	001 202
05 020235	001 186	05 022043	001 204	05 022630	001 203	05 022705	001 202
05 020240	001 185	05 022044	001 204	05 022631	001 203	05 022706	001 202
05 020241	001 183	05 022045	001 204	05 022632	001 203	05 022708	001 202
05 020259	001 181	05 022046	001 204	05 022633	001 203	05 022709	001 202
05 020260	001 181	05 022047	001 204	05 022634	001 203	05 022710	001 202
05 020261	001 181	05 022048	001 204	05 022635	001 203	05 022711	001 202
05 020262	001 181	05 022050	001 204	05 022636	001 203	05 022712	001 202
05 020263	001 181	05 022052	001 204	05 022637	001 203	05 022713	001 202
05 020264	001 181	05 022054	001 204	05 022638	001 203	05 022714	001 202
05 020302	001 183	05 022056	001 204	05 022639	001 195	05 022715	001 202
05 020310	001 189	05 022058	001 204	05 022640	001 195	05 022716	001 202
05 020311	001 189	05 022060	001 204	05 022641	001 195	05 022717	001 202
05 020312	001 189	05 022062	001 204	05 022651	001 203	05 022718	001 202
05 020313	001 189	05 022063	001 204	05 022652	001 203	05 022720	001 192
05 020314	001 189	05 022064	001 204	05 022653	001 203	05 022721	001 193
05 020500	001 181	05 022066	001 204	05 022654	001 203	05 022728	001 57
05 020501	001 181	05 022067	001 204	05 022655	001 203	05 022729	001 56
05 020502	001 181	05 022068	001 204	05 022656	001 203	05 022730	001 56
05 020503	001 181	05 022070	001 204	05 022657	001 203	05 022731	001 56
05 020504	001 181	05 022071	001 204	05 022658	001 203	05 022732	001 56
05 020505	001 181	05 022072	001 204	05 022659	001 203	05 022733	001 56
05 020506	001 181	05 022073	001 204	05 022660	001 201	05 022734	001 56
05 020507	001 181	05 022074	001 204	05 022661	001 201	05 022740	001 56
05 021005	001 205	05 022076	001 204	05 022662	001 201	05 022741	001 56
05 021010	001 205	05 022078	001 204	05 022663	001 201	05 022745	001 57
05 021015	001 205	05 022079	001 204	05 022664	001 201	05 022760	001 57
05 021020	001 205	05 022080	001 204	05 022665	001 201	05 022761	001 57
05 021025	001 205	05 022081	001 204	05 022666	001 201	05 022762	001 57
05 021030	001 205	05 022082	001 204	05 022667	001 201	05 022763	001 57
05 021035	001 205	05 022086	001 197	05 022668	001 201	05 022764	001 57
05 021040	001 205	05 022087	001 196	05 022669	001 192	05 022765	001 57
05 021045	001 205	05 022089	001 193	05 022670	001 203	05 022766	001 57
05 021050	001 205	05 022095	001 204	05 022671	001 203	05 022767	001 57
05 021055	001 205	05 022096	001 204	05 022672	001 203	05 022795	001 15
05 021060	001 205	05 022101	001 198	05 022673	001 203	05 022800	001 15
05 021065	001 205	05 022102	001 198	05 022674	001 203	05 022805	001 15
05 021070	001 205	05 022120	001 205	05 022675	001 203	05 022810	001 15
05 021075	001 205	05 022121	001 205	05 022676	001 203	05 022815	001 15
05 021080	001 205	05 022122	001 205	05 022677	001 203	05 022820	001 15
05 021085	001 205	05 022123	001 205	05 022678	001 203	05 022825	001 15
05 021090	001 205	05 022124	001 205	05 022680	001 209	05 022830	001 15
05 021095	001 205	05 022125	001 205	05 022681	001 209	05 022835	001 15
05 021406	001 197	05 022130	001 196	05 022682	001 209	05 022850	001 202
05 021600	001 205	05 022171	001 200	05 022683	001 209	05 022851	001 202
05 021605	001 205	05 022181	001 198	05 022684	001 209	05 022852	001 202
05 021610	001 205	05 022200	001 202	05 022685	001 209	05 022853	001 202
05 021615	001 205	05 022201	001 202	05 022686	001 209	05 022854	001 202
05 021620	001 205	05 022202	001 202	05 022687	001 209	05 022855	001 202
05 021625	001 205	05 022203	001 202	05 022688	001 209	05 022856	001 202
05 021630	001 205	05 022204	001 202	05 022689	001 207	05 022857	001 202
05 021632	001 205	05 022205	001 202	05 022693	001 201	05 022858	001 202
05 021635	001 205	05 022210	001 193	05 022694	001 201	05 022860	001 195
05 021640	001 205	05 022534	001 196	05 022695	001 201	05 022905	001 15
05 021645	001 205	05 022600	001 203	05 022696	001 201	05 022910	001 15
05 021721	001 199	05 022602	001 203	05 022697	001 201	05 022920	001 15

# Code No. Index

Code No.	Page	Code No.	Page	Code No.	Page	Code No.	Page
05 023105	001 14	05 023450	001 43	05 024401	001 9	05 027105	001 204
05 023107	001 14	05 023451	001 44	05 024402	001 9	05 027106	001 204
05 023110	001 14	05 023452	001 45	05 024403	001 9	05 027107	001 204
05 023115	001 14	05 023453	001 43	05 024404	001 9	05 027108	001 204
05 023120	001 14	05 023454	001 44	05 024405	001 9	05 027109	001 204
05 023125	001 14	05 023456	001 45	05 024410	001 11	05 027110	001 204
05 023130	001 14	05 023460	001 42	05 024450	001 207	05 027111	001 204
05 023330	001 39	05 023461	001 42	05 024451	001 210	05 027201	001 206
05 023332	001 39	05 023470	001 229	05 024452	001 210	05 027202	001 206
05 023334	001 40	05 023471	001 228	05 024453	001 210	05 027203	001 206
05 023338	001 40	05 024001	001 211	05 024454	001 210	05 027204	001 206
05 023339	001 40	05 024002	001 211	05 024455	001 210	05 027205	001 206
05 023340	001 40	05 024003	001 211	05 024456	001 210	05 027206	001 206
05 023342	001 40	05 024004	001 211	05 024457	001 210	05 027207	001 206
05 023343	001 40	05 024005	001 211	05 024458	001 210	05 027208	001 206
05 023344	001 40	05 024008	001 211	05 024459	001 210	05 027209	001 206
05 023346	001 40	05 024010	001 211	05 024460	001 208	05 027210	001 206
05 023347	001 40	05 024012	001 211	05 024461	001 211	05 027211	001 206
05 023348	001 40	05 024013	001 211	05 024462	001 211	05 027212	001 206
05 023350	001 40	05 024015	001 211	05 024463	001 211	05 027213	001 206
05 023351	001 40	05 024020	001 211	05 024464	001 210	05 027214	001 206
05 023352	001 40	05 024100	001 211	05 024465	001 210	05 027215	001 206
05 023353	001 40	05 024105	001 211	05 024466	001 210	05 027405	001 29
05 023354	001 40	05 024160	001 211	05 024467	001 210	05 027450	001 49
05 023355	001 40	05 024161	001 211	05 024468	001 210	05 027455	001 29
05 023356	001 40	05 024162	001 211	05 024469	001 210	05 027456	001 35
05 023357	001 40	05 024163	001 211	05 024470	001 207	05 027910	001 393
05 023358	001 40	05 024164	001 211	05 024471	001 209	05 027911	001 393
05 023359	001 40	05 024165	001 211	05 024472	001 209	05 027912	001 393
05 023360	001 40	05 024166	001 211	05 024473	001 209	05 027913	001 393
05 023361	001 40	05 024167	001 211	05 024474	001 209	05 027930	001 393
05 023362	001 40	05 024168	001 211	05 024475	001 209	05 027931	001 393
05 023363	001 40	05 024170	001 209	05 024476	001 209	05 027932	001 393
05 023364	001 40	05 024171	001 209	05 024477	001 209	05 027933	001 393
05 023365	001 40	05 024172	001 209	05 024478	001 209	05 027934	001 393
05 023366	001 40	05 024173	001 209	05 024479	001 209	05 027935	001 393
05 023367	001 40	05 024174	001 209	05 024480	001 207	05 027936	001 394
05 023368	001 40	05 024175	001 209	05 024481	001 210	05 028000	001 16
05 023369	001 40	05 024176	001 209	05 024482	001 210	05 028001	001 16
05 023370	001 40	05 024177	001 209	05 024483	001 210	05 028002	001 16
05 023371	001 40	05 024178	001 209	05 024484	001 209	05 028003	001 16
05 023372	001 40	05 024179	001 207	05 024485	001 209	05 028004	001 16
05 023373	001 40	05 024199	001 211	05 024486	001 209	05 028005	001 16
05 023374	001 40	05 024200	001 211	05 024487	001 209	05 028008	001 16
05 023375	001 40	05 024202	001 211	05 024488	001 209	05 028010	001 16
05 023376	001 40	05 024204	001 211	05 024489	001 209	05 028012	001 16
05 023377	001 40	05 024206	001 211	05 026350	001 28	05 028013	001 16
05 023378	001 40	05 024208	001 211	05 026351	001 28	05 028015	001 16
05 023379	001 40	05 024210	001 211	05 026352	001 28	05 028020	001 16
05 023380	001 40	05 024242	001 208	05 026353	001 28	05 028029	001 17
05 023381	001 41	05 024244	001 207	05 026354	001 28	05 028030	001 17
05 023382	001 41	05 024335	001 208	05 026360	001 28	05 028031	001 17
05 023383	001 41	05 024350	001 210	05 026361	001 28	05 028032	001 17
05 023384	001 41	05 024351	001 210	05 026363	001 28	05 028033	001 17
05 023385	001 41	05 024352	001 210	05 026372	001 28	05 028034	001 17
05 023386	001 41	05 024353	001 210	05 026373	001 28	05 028035	001 17
05 023387	001 41	05 024354	001 210	05 026374	001 28	05 028036	001 17
05 023389	001 41	05 024355	001 210	05 026382	001 28	05 028037	001 17
05 023391	001 41	05 024356	001 210	05 027101	001 204	05 028038	001 17
05 023393	001 41	05 024357	001 210	05 027102	001 204	05 028040	001 394
05 023400	001 254	05 024358	001 210	05 027103	001 204	05 028041	001 394
05 023404	001 41	05 024400	001 9	05 027104	001 204	05 028042	001 394

Code No.	Page	Code No.	Page	Code No.	Page	Code No.	Page
05 028043 001	394	05 030100 001	47	05 032031 001	7	05 051065 001	234
05 028044 001	394	05 030101 001	47	05 032032 001	7	05 051066 001	235
05 028045 001	394	05 030102 001	47	05 032033 001	7	05 051205 001	250
05 028046 001	394	05 030103 001	47	05 032050 001	7	05 051272 001	249
05 028048 001	15	05 030104 001	47	05 032051 001	7	05 051273 001	52
05 028049 001	15	05 030105 001	47	05 032052 001	7	05 051274 001	250
05 028050 001	15	05 030106 001	47	05 032053 001	7	05 051276 001	35
05 028051 001	15	05 030107 001	47	05 032054 001	7	05 051461 001	251
05 028052 001	15	05 030108 001	47	05 032055 001	7	05 051462 001	249
05 028053 001	15	05 030109 001	48	05 032056 001	7	05 051464 001	52
05 028054 001	15	05 030110 001	47	05 032057 001	7	05 051465 001	248
05 028055 001	15	05 030111 001	47	05 032058 001	7	05 051482 001	248
05 028056 001	15	05 030112 001	47	05 032060 001	7	05 051492 001	247
05 028059 001	25	05 030113 001	48	05 032061 001	7	05 051493 001	247
05 028062 001	25	05 030114 001	48	05 032063 001	8	05 051500 001	338
05 028070 001	15	05 030115 001	48	05 032070 002	7	05 051501 001	338
05 028071 001	15	05 030116 001	48	05 032071 002	7	05 051502 001	338
05 028072 001	15	05 030117 001	47	05 033404 001	29	05 051510 001	219
05 028073 001	15	05 030118 001	47	05 040001 001	254	05 051511 001	220
05 028074 001	25	05 030119 001	47	05 042605 001	343	05 051512 001	220
05 028148 001	18	05 030120 001	48	05 042655 001	343	05 051575 001	85
05 028150 001	18	05 030121 001	48	05 042665 001	343	05 051576 001	85
05 028152 001	18	05 030122 001	48	05 042670 001	342	05 051580 001	84
05 028160 001	249	05 030135 001	48	05 042671 001	342	05 051582 001	84
05 028161 001	249	05 030150 001	49	05 042672 001	342	05 051583 001	84
05 028205 001	18	05 030151 001	49	05 042673 001	342	05 051587 001	84
05 028210 001	18	05 030158 001	48	05 042674 001	342	05 051601 001	85
05 028215 001	18	05 030159 001	48	05 042680 001	342	05 051603 001	85
05 028220 001	18	05 030160 001	33	05 042705 001	343	05 051611 001	85
05 028225 001	18	05 030170 001	51	05 042715 001	343	05 051613 001	85
05 028230 001	18	05 030180 001	51	05 042750 001	343	05 051835 001	254
05 029405 001	18	05 030181 001	38	05 042755 001	343	05 052490 001	336
05 029410 001	18	05 030330 001	49	05 042760 001	343	05 052500 001	336
05 029415 001	18	05 030331 001	49	05 042765 001	343	05 052501 001	337
05 029420 001	18	05 030400 001	48	05 042768 001	343	05 052502 001	336
05 029425 001	18	05 030401 001	48	05 050005 001	103	05 052503 001	336
05 029430 001	18	05 030402 001	48	05 050205 001	341	05 052504 001	336
05 029435 001	18	05 030403 001	48	05 050210 001	341	05 052575 001	338
05 029440 001	18	05 030404 001	48	05 050215 001	341	05 053425 001	339
05 029445 001	18	05 030405 001	48	05 050220 001	341	05 053455 001	339
05 029450 001	18	05 030406 001	48	05 050510 001	341	05 053457 001	339
05 029460 001	19	05 030410 001	49	05 050650 001	341	05 053458 001	339
05 029461 001	19	05 030411 001	49	05 051005 001	250	05 053459 001	339
05 029462 001	19	05 030412 001	49	05 051010 001	21	05 053520 001	337
05 029463 001	19	05 030413 001	49	05 051011 001	22	05 053522 001	337
05 029464 001	19	05 030414 001	49	05 051012 001	20	05 053870 001	337
05 029465 001	19	05 030415 001	49	05 051016 001	216	05 053872 001	337
05 029466 001	19	05 030416 001	49	05 051017 001	217	05 053923 001	335
05 029501 001	19	05 030417 001	49	05 051021 001	217	05 056064 001	315
05 029502 001	19	05 030418 001	49	05 051024 001	218	05 056066 001	315
05 029503 001	19	05 032001 001	6	05 051025 001	218	05 056068 001	315
05 029504 001	19	05 032002 001	6	05 051028 001	218	05 056158 001	360
05 029505 001	19	05 032003 001	6	05 051030 001	252	05 056159 001	358
05 029506 001	19	05 032004 001	6	05 051031 001	252	05 056161 001	357
05 029507 001	19	05 032005 001	6	05 051032 001	219	05 056164 001	358
05 029510 001	26	05 032006 001	6	05 051040 001	251	05 056168 001	360
05 030080 001	49	05 032007 001	6	05 051041 001	251	05 056172 001	314
05 030081 001	49	05 032020 001	6	05 051042 001	224	05 056174 001	314
05 030082 001	49	05 032021 001	6	05 051043 001	52	05 056176 001	314
05 030083 001	49	05 032022 001	6	05 051045 001	98	05 056200 001	315
05 030084 001	49	05 032023 001	6	05 051060 001	234	05 056203 001	315
05 030099 001	47	05 032030 001	7	05 051061 001	235	05 056210 001	315

# Code No. Index

Code No.	Page	Code No.	Page	Code No.	Page	Code No.	Page
05 056220	001 315	05 056681	001 318	05 057450	001 355	05 057705	001 294
05 056225	001 315	05 056682	001 318	05 057460	001 227	05 057710	001 294
05 056233	001 315	05 056683	001 318	05 057470	001 228	05 057715	001 294
05 056240	001 315	05 056684	001 318	05 057471	001 238	05 057720	001 294
05 056294	001 360	05 056685	001 318	05 057472	001 54	05 057750	001 289
05 056295	001 359	05 056686	001 318	05 057473	001 229	05 057751	001 286
05 056296	001 359	05 056687	001 318	05 057474	001 230	05 057752	001 284
05 056303	001 318	05 056700	001 296	05 057480	001 215	05 057760	001 299
05 056305	001 318	05 056702	001 296	05 057481	001 79	05 057761	001 297
05 056310	001 318	05 056704	001 296	05 057482	001 214	05 057762	001 297
05 056315	001 318	05 056710	001 297	05 057483	001 214	05 057763	001 295
05 056320	001 318	05 056712	001 297	05 057490	001 69	05 057770	001 307
05 056325	001 318	05 056714	001 297	05 057505	001 322	05 057772	001 303
05 056330	001 318	05 056720	001 297	05 057510	001 322	05 057773	001 307
05 056332	001 318	05 056722	001 297	05 057515	001 322	05 057775	001 303
05 056335	001 318	05 056724	001 297	05 057520	001 322	05 057776	001 303
05 056340	001 318	05 056805	001 298	05 057525	001 322	05 057777	001 306
05 056341	001 322	05 056810	001 298	05 057530	001 322	05 057778	001 306
05 056342	001 322	05 056812	001 298	05 057603	001 317	05 057790	001 324
05 056343	001 322	05 056815	001 298	05 057604	001 317	05 057900	001 356
05 056344	001 322	05 056820	001 298	05 057605	001 317	05 057908	001 356
05 056345	001 322	05 056825	001 298	05 057606	001 317	05 058005	001 302
05 056346	001 322	05 056835	001 298	05 057615	001 284	05 058010	001 302
05 056350	001 319	05 056910	001 298	05 057616	001 284	05 058015	001 302
05 056352	001 319	05 056915	001 298	05 057617	001 284	05 058020	001 302
05 056354	001 319	05 056925	001 298	05 057620	001 295	05 058029	001 222
05 056356	001 319	05 057113	001 226	05 057621	001 295	05 059293	001 224
05 056358	001 319	05 057114	001 226	05 057622	001 295	05 059295	001 223
05 056374	001 352	05 057115	001 358	05 057623	001 303	05 059297	001 225
05 056375	001 357	05 057122	001 355	05 057624	001 303	05 059298	001 221
05 056400	001 285	05 057150	001 329	05 057625	001 303	05 059299	001 221
05 056402	001 285	05 057151	001 329	05 057626	001 303	05 059305	001 316
05 056404	001 285	05 057152	001 329	05 057627	001 303	05 059307	001 316
05 056410	001 285	05 057153	001 329	05 057628	001 303	05 059310	001 316
05 056412	001 285	05 057160	001 329	05 057631	001 324	05 059315	001 316
05 056414	001 285	05 057161	001 329	05 057632	001 324	05 059320	001 316
05 056420	001 286	05 057162	001 329	05 057644	001 319	05 059325	001 316
05 056422	001 286	05 057163	001 329	05 057645	001 319	05 059330	001 316
05 056424	001 286	05 057225	001 316	05 057646	001 319	05 059335	001 316
05 056440	001 356	05 057235	001 316	05 057656	001 289	05 059337	001 316
05 056470	001 366	05 057240	001 316	05 057657	001 289	05 059340	001 316
05 056471	001 362	05 057412	001 354	05 057661	001 299	05 059345	001 316
05 056472	001 362	05 057415	001 354	05 057662	001 299	05 059450	001 316
05 056473	001 361	05 057416	001 353	05 057664	001 308	05 059451	001 316
05 056474	001 361	05 057417	001 347	05 057665	001 308	05 059452	001 316
05 056478	001 362	05 057418	001 167	05 057666	001 308	05 059453	001 316
05 056490	001 165	05 057420	001 351	05 057667	001 308	05 059466	001 316
05 056491	001 165	05 057421	001 353	05 057671	001 325	05 059472	001 316
05 056500	001 288	05 057422	001 365	05 057672	001 325	05 059478	001 316
05 056505	001 288	05 057423	001 365	05 057675	001 334	05 059480	001 316
05 056507	001 288	05 057424	001 368	05 057676	001 334	05 059486	001 316
05 056510	001 288	05 057430	001 351	05 057680	001 346	05 059488	001 316
05 056515	001 288	05 057431	001 353	05 057682	001 347	05 059489	001 316
05 056520	001 288	05 057432	001 364	05 057683	001 347	05 059490	001 316
05 056525	001 288	05 057433	001 363	05 057684	001 347	05 059492	001 316
05 056535	001 288	05 057434	001 367	05 057688	001 347	05 059496	001 316
05 056605	001 287	05 057435	001 364	05 057690	001 346	05 059500	001 316
05 056610	001 287	05 057436	001 363	05 057691	001 348	05 059530	001 290
05 056625	001 287	05 057437	001 363	05 057692	001 348	05 059532	001 290
05 056653	001 215	05 057438	001 364	05 057693	001 348	05 059534	001 290
05 056662	001 288	05 057440	001 367	05 057695	001 348	05 059540	001 291
05 056680	001 318	05 057441	001 350	05 057697	001 346	05 059542	001 291

Code No.	Page	Code No.	Page	Code No.	Page	Code No.	Page
05 059544	001 291	05 059805	001 292	05 060140	001 312	05 060297	001 327
05 059550	001 291	05 059810	001 292	05 060141	001 312	05 060298	001 327
05 059552	001 291	05 059815	001 292	05 060142	001 312	05 060300	001 327
05 059554	001 291	05 059855	001 292	05 060143	001 312	05 060301	001 327
05 059602	001 321	05 059860	001 292	05 060144	001 312	05 060302	001 327
05 059603	001 321	05 059865	001 292	05 060145	001 312	05 060303	001 327
05 059604	001 321	05 059896	001 303	05 060146	001 312	05 060304	001 327
05 059605	001 321	05 059897	001 303	05 060147	001 326	05 060400	001 329
05 059610	001 321	05 059900	001 300	05 060148	001 326	05 060401	001 329
05 059615	001 321	05 059902	001 300	05 060149	001 326	05 060402	001 329
05 059620	001 321	05 059904	001 300	05 060150	001 326	05 060403	001 329
05 059625	001 321	05 059910	001 300	05 060155	001 326	05 060404	001 329
05 059628	001 321	05 059912	001 300	05 060160	001 326	05 060405	001 329
05 059629	001 321	05 059914	001 300	05 060165	001 326	05 060406	001 329
05 059630	001 321	05 059920	001 301	05 060170	001 326	05 060407	001 329
05 059631	001 321	05 059922	001 301	05 060175	001 326	05 060408	001 329
05 059632	001 321	05 059924	001 301	05 060180	001 326	05 060409	001 329
05 059633	001 321	05 060005	001 301	05 060182	001 326	05 060410	001 329
05 059634	001 321	05 060010	001 301	05 060184	001 326	05 060411	001 329
05 059635	001 321	05 060015	001 301	05 060185	001 310	05 060412	001 329
05 059636	001 321	05 060027	001 302	05 060186	001 310	05 060420	001 330
05 059637	001 321	05 060029	001 302	05 060187	001 310	05 060421	001 330
05 059640	001 323	05 060030	001 302	05 060188	001 310	05 060422	001 330
05 059641	001 323	05 060031	001 302	05 060189	001 310	05 060423	001 330
05 059642	001 323	05 060033	001 302	05 060190	001 310	05 060424	001 330
05 059643	001 323	05 060035	001 302	05 060191	001 310	05 060425	001 330
05 059644	001 323	05 060036	001 302	05 060192	001 310	05 060426	001 330
05 059645	001 323	05 060037	001 302	05 060193	001 310	05 060427	001 330
05 059660	001 321	05 060038	001 302	05 060194	001 310	05 060428	001 330
05 059661	001 321	05 060041	001 302	05 060195	001 310	05 060429	001 330
05 059662	001 321	05 060043	001 302	05 060196	001 310	05 060430	001 330
05 059663	001 321	05 060045	001 302	05 060197	001 310	05 060431	001 330
05 059664	001 321	05 060047	001 302	05 060198	001 310	05 060432	001 330
05 059665	001 321	05 060048	001 312	05 060199	001 310	05 060505	001 309
05 059666	001 321	05 060049	001 312	05 060200	001 310	05 060506	001 309
05 059667	001 321	05 060050	001 312	05 060201	001 310	05 060507	001 309
05 059668	001 321	05 060051	001 312	05 060202	001 310	05 060508	001 309
05 059680	001 322	05 060052	001 312	05 060210	001 330	05 060509	001 309
05 059681	001 322	05 060053	001 312	05 060215	001 330	05 060510	001 309
05 059682	001 322	05 060054	001 312	05 060220	001 330	05 060511	001 309
05 059683	001 322	05 060055	001 301	05 060225	001 330	05 064155	001 311
05 059700	001 309	05 060056	001 312	05 060230	001 330	05 064170	001 311
05 059701	001 309	05 060057	001 312	05 060235	001 330	05 064175	001 311
05 059702	001 309	05 060060	001 301	05 060237	001 330	05 065081	001 294
05 059703	001 309	05 060065	001 301	05 060238	001 330	05 065096	001 302
05 059704	001 309	05 060098	001 310	05 060240	001 330	05 065110	001 294
05 059705	001 309	05 060100	001 310	05 060255	001 330	05 065112	001 294
05 059720	001 302	05 060105	001 310	05 060260	001 330	05 065114	001 294
05 059721	001 302	05 060110	001 310	05 060265	001 330	05 065129	001 302
05 059755	001 292	05 060115	001 310	05 060272	001 329	05 065197	001 294
05 059760	001 292	05 060120	001 310	05 060274	001 329	05 066081	001 308
05 059765	001 292	05 060125	001 310	05 060276	001 329	05 066082	001 308
05 059766	001 292	05 060130	001 310	05 060278	001 329	05 066083	001 308
05 059770	001 292	05 060131	001 310	05 060280	001 329	05 066100	001 305
05 059775	001 292	05 060132	001 310	05 060281	001 329	05 066102	001 305
05 059780	001 292	05 060133	001 310	05 060282	001 329	05 066104	001 305
05 059785	001 292	05 060134	001 310	05 060283	001 329	05 066106	001 305
05 059786	001 292	05 060135	001 310	05 060284	001 329	05 066108	001 305
05 059790	001 292	05 060136	001 310	05 060286	001 329	05 066110	001 305
05 059795	001 292	05 060137	001 310	05 060288	001 329	05 066120	001 305
05 059800	001 292	05 060138	001 310	05 060290	001 329	05 066122	001 305
05 059802	001 292	05 060139	001 312	05 060296	001 327	05 066124	001 305

# Code No. Index

Code No.	Page	Code No.	Page	Code No.	Page	Code No.	Page
05 066126	001 305	05 066495	001 306	05 066788	001 328	05 071110	001 349
05 066128	001 305	05 066496	001 306	05 066850	001 328	05 071116	001 222
05 066130	001 305	05 066497	001 311	05 066851	001 328	05 071117	001 223
05 066140	001 305	05 066498	001 311	05 066852	001 328	05 071222	001 329
05 066141	001 305	05 066499	001 311	05 066853	001 328	05 071223	001 329
05 066142	001 305	05 066500	001 311	05 066854	001 328	05 071224	001 329
05 066143	001 305	05 066505	001 311	05 066900	001 311	05 071225	001 329
05 066144	001 305	05 066510	001 311	05 066901	001 311	05 071228	001 329
05 066145	001 305	05 066515	001 311	05 066902	001 311	05 072014	001 426
05 066150	001 328	05 066520	001 311	05 066905	001 311	05 072017	001 426
05 066155	001 328	05 066525	001 311	05 066910	001 311	05 072050	001 315
05 066160	001 328	05 066530	001 311	05 066915	001 311	05 072055	001 315
05 066165	001 328	05 066618	001 327	05 066920	001 311	05 072057	001 315
05 066170	001 328	05 066619	001 327	05 066925	001 311	05 072059	001 315
05 066272	001 313	05 066620	001 327	05 066941	001 311	05 072061	001 315
05 066274	001 313	05 066622	001 327	05 066950	001 311	05 072063	001 315
05 066276	001 313	05 066624	001 327	05 071010	001 284	05 072065	001 315
05 066278	001 313	05 066626	001 327	05 071011	001 284	05 072070	001 288
05 066279	001 313	05 066628	001 327	05 071012	001 284	05 072072	001 288
05 066280	001 313	05 066630	001 327	05 071020	001 296	05 072074	001 288
05 066282	001 313	05 066632	001 327	05 071021	001 296	05 072080	001 298
05 066284	001 313	05 066633	001 327	05 071022	001 296	05 072082	001 298
05 066286	001 313	05 066634	001 327	05 071030	001 304	05 072084	001 298
05 066287	001 313	05 066635	001 327	05 071032	001 304	05 072400	001 288
05 066288	001 313	05 066638	001 327	05 071033	001 304	05 072401	001 288
05 066290	001 313	05 066640	001 327	05 071034	001 304	05 072402	001 288
05 066300	001 306	05 066642	001 327	05 071035	001 304	05 072403	001 299
05 066301	001 306	05 066644	001 327	05 071037	001 304	05 072404	001 299
05 066302	001 306	05 066646	001 327	05 071038	001 304	05 072405	001 299
05 066303	001 306	05 066654	001 328	05 071070	001 317	05 072406	001 307
05 066304	001 306	05 066656	001 328	05 071071	001 317	05 072407	001 307
05 066305	001 306	05 066660	001 328	05 071072	001 317	05 072408	001 307
05 066308	001 306	05 066662	001 328	05 071073	001 317	05 072409	001 307
05 066310	001 306	05 066664	001 328	05 071074	001 317	05 072411	001 307
05 066312	001 306	05 066666	001 328	05 071075	001 317	05 072412	001 307
05 066313	001 306	05 066668	001 328	05 071076	001 317	05 072441	001 289
05 066315	001 306	05 066670	001 328	05 071077	001 317	05 072443	001 299
05 066320	001 306	05 066672	001 328	05 071080	001 315	05 072444	001 299
05 066325	001 306	05 066674	001 328	05 071081	001 290	05 072446	001 307
05 066330	001 306	05 066676	001 328	05 071082	001 290	05 072447	001 307
05 066335	001 306	05 066678	001 328	05 071083	001 290	05 072448	001 307
05 066394	001 324	05 066680	001 328	05 071084	001 300	05 072449	001 307
05 066395	001 325	05 066682	001 328	05 071085	001 300	05 072451	001 307
05 066396	001 324	05 066683	001 328	05 071086	001 300	05 072452	001 307
05 066400	001 325	05 066684	001 328	05 071089	001 312	05 073050	001 319
05 066405	001 325	05 066685	001 328	05 071090	001 312	05 073051	001 319
05 066410	001 325	05 066686	001 328	05 071091	001 312	05 073052	001 319
05 066415	001 325	05 066687	001 328	05 071092	001 312	05 073053	001 319
05 066420	001 325	05 066688	001 327	05 071094	001 312	05 073054	001 319
05 066455	001 307	05 066690	001 327	05 071097	001 326	05 073055	001 319
05 066460	001 307	05 066692	001 327	05 071098	001 326	05 073056	001 321
05 066465	001 307	05 066694	001 327	05 071099	001 326	05 073057	001 321
05 066485	001 306	05 066696	001 327	05 071100	001 335	05 073058	001 321
05 066486	001 306	05 066758	001 328	05 071101	001 320	05 073059	001 321
05 066487	001 306	05 066760	001 328	05 071102	001 320	05 073060	001 321
05 066488	001 306	05 066762	001 328	05 071103	001 320	05 073061	001 321
05 066489	001 306	05 066764	001 328	05 071104	001 320	05 073064	001 312
05 066490	001 306	05 066766	001 328	05 071105	001 320	05 073065	001 312
05 066491	001 306	05 066768	001 328	05 071106	001 320	05 073066	001 312
05 066492	001 306	05 066785	001 328	05 071107	001 320	05 073070	001 313
05 066493	001 306	05 066786	001 328	05 071108	001 320	05 073071	001 313
05 066494	001 306	05 066787	001 328	05 071109	001 349	05 073072	001 313



Code No.	Page	Code No.	Page	Code No.	Page	Code No.	Page
05 073073	001 313	05 073339	001 297	05 073611	001 285	05 073980	001 347
05 073074	001 325	05 073340	001 306	05 073613	001 296	05 073984	001 55
05 073075	001 325	05 073342	001 319	05 073614	001 296	05 073985	001 341
05 073076	001 326	05 073344	001 319	05 073615	001 296	05 073990	001 334
05 073077	001 326	05 073346	001 306	05 073616	001 335	05 074700	001 376
05 073200	001 341	05 073357	001 339	05 073620	001 304	05 074701	001 376
05 073201	001 323	05 073370	001 298	05 073621	001 304	05 074702	001 376
05 073202	001 323	05 073371	001 298	05 073622	001 304	05 074705	001 376
05 073210	001 340	05 073372	001 298	05 073623	001 304	05 074710	001 376
05 073220	001 166	05 073373	001 298	05 073625	001 304	05 074711	001 376
05 073230	001 172	05 073375	001 306	05 073630	001 349	05 074712	001 376
05 073240	001 220	05 073376	001 306	05 073631	001 373	05 074715	001 381
05 073241	001 220	05 073380	001 299	05 073634	001 349	05 074715	010 386
05 073260	001 98	05 073391	001 196	05 073635	001 361	05 074716	001 381
05 073261	001 116	05 073401	001 338	05 073637	001 362	05 074716	010 386
05 073262	001 138	05 073404	001 360	05 073638	001 361	05 074717	001 382
05 073268	001 176	05 073406	001 359	05 073639	001 366	05 074717	010 387
05 073270	001 176	05 073410	001 357	05 073640	001 163	05 074720	001 382
05 073271	001 176	05 073416	001 358	05 073641	001 365	05 074720	010 387
05 073272	001 176	05 073418	001 352	05 073645	001 167	05 074721	001 383
05 073273	001 176	05 073419	001 354	05 073660	001 253	05 074721	010 388
05 073274	001 176	05 073420	001 335	05 073661	002 253	05 074722	001 382
05 073275	001 176	05 073421	001 336	05 073665	001 252	05 074722	010 387
05 073276	001 176	05 073470	001 310	05 073670	001 54	05 074728	001 382
05 073277	001 176	05 073471	001 310	05 073671	001 53	05 074728	010 387
05 073278	001 176	05 073472	001 310	05 073675	001 36	05 074730	001 380
05 073279	001 176	05 073473	001 310	05 073676	001 37	05 074731	001 380
05 073280	001 176	05 073474	001 310	05 073677	001 37	05 074733	001 380
05 073281	001 176	05 073495	001 331	05 073680	001 30	05 074734	001 380
05 073282	001 176	05 073500	001 330	05 073681	001 30	05 074738	001 378
05 073283	001 176	05 073501	001 330	05 073720	001 310	05 074739	001 379
05 073284	001 176	05 073502	001 330	05 073721	001 310	05 074745	001 379
05 073285	001 176	05 073503	001 330	05 073722	001 310	05 074746	001 378
05 073286	001 176	05 073504	001 330	05 073723	001 310	05 074750	001 77
05 073287	001 176	05 073505	001 330	05 073724	001 310	05 074752	001 77
05 073290	001 178	05 073506	001 330	05 073890	001 348	05 074757	001 77
05 073295	001 179	05 073507	001 330	05 073904	001 317	05 074770	001 376
05 073304	001 288	05 073508	001 330	05 073905	001 317	05 074772	001 376
05 073305	001 288	05 073509	001 330	05 073906	001 317	05 074774	001 376
05 073306	001 288	05 073510	001 330	05 073916	001 284	05 074780	001 380
05 073307	001 288	05 073511	001 336	05 073917	001 284	05 074782	001 380
05 073308	001 299	05 073520	001 293	05 073921	001 295	05 074784	001 380
05 073309	001 299	05 073521	001 293	05 073922	001 295	05 074786	001 380
05 073310	001 299	05 073522	001 293	05 073924	001 303	05 074788	001 380
05 073311	001 299	05 073523	001 302	05 073925	001 303	05 074790	001 381
05 073313	001 306	05 073524	001 302	05 073926	001 303	05 074790	010 386
05 073314	001 306	05 073525	001 302	05 073927	001 303	05 074792	001 381
05 073315	001 306	05 073526	001 310	05 073931	001 324	05 074792	010 386
05 073316	001 306	05 073527	001 310	05 073932	001 324	05 074794	001 381
05 073317	001 306	05 073528	001 310	05 073944	001 320	05 074794	010 386
05 073318	001 337	05 073529	001 310	05 073945	001 320	05 074800	001 385
05 073323	001 288	05 073530	001 310	05 073946	001 320	05 074800	010 389
05 073324	001 288	05 073531	001 310	05 073956	001 290	05 074802	001 380
05 073325	001 288	05 073540	001 249	05 073957	001 290	05 074804	001 380
05 073326	001 288	05 073541	001 248	05 073961	001 300	05 074810	001 385
05 073332	001 285	05 073544	001 193	05 073962	001 300	05 074810	010 389
05 073333	001 285	05 073593	001 194	05 073964	001 308	05 074820	001 384
05 073334	001 285	05 073594	001 197	05 073965	001 308	05 074820	010 390
05 073335	001 285	05 073596	001 197	05 073966	001 308	05 074822	001 384
05 073336	001 297	05 073598	001 208	05 073967	001 308	05 074822	010 390
05 073337	001 297	05 073599	001 208	05 073971	001 326	05 074824	001 384
05 073338	001 297	05 073610	001 285	05 073972	001 326	05 074824	010 390

# Code No. Index

Code No.	Page	Code No.	Page	Code No.	Page	Code No.	Page
05 074826 001	384	05 078610 001	414	05 078695 001	417	05 100081 001	9
05 074826 010	390	05 078611 001	414	05 078696 001	417	05 100082 001	9
05 074828 001	384	05 078612 001	414	05 078697 001	417	05 100085 001	8
05 074828 010	390	05 078620 001	416	05 078698 001	417	05 100086 001	8
05 074840 001	383	05 078621 001	416	05 078699 001	417	05 100087 001	8
05 074840 010	389	05 078622 001	416	05 078700 001	417	05 100100 001	62
05 074842 001	383	05 078623 001	416	05 078701 001	417	05 104600 001	371
05 074842 010	389	05 078624 001	416	05 078702 001	417	05 104601 001	371
05 075604 001	398	05 078625 001	416	05 078703 001	417	05 104602 001	371
05 075605 001	398	05 078626 001	416	05 078704 001	417	05 104603 001	371
05 075610 001	401	05 078627 001	416	05 078705 001	417	05 104604 001	371
05 075611 001	401	05 078628 001	416	05 078706 001	425	05 104605 001	371
05 075620 001	402	05 078629 001	416	05 078707 001	419	05 104610 001	371
05 075621 001	402	05 078630 001	416	05 078708 001	419	05 104611 001	371
05 075622 001	403	05 078631 001	416	05 078709 001	425	05 104612 001	371
05 075623 001	405	05 078632 001	416	05 078710 001	421	05 104613 001	371
05 075624 001	405	05 078633 001	416	05 078711 001	425	05 104614 001	371
05 075625 001	406	05 078635 001	418	05 078714 001	423	05 104615 001	371
05 075626 001	406	05 078636 001	418	05 078715 001	423	05 104616 001	371
05 075630 001	405	05 078637 001	418	05 078716 001	423	05 104617 001	371
05 075631 001	407	05 078640 001	421	05 078717 001	423	05 104618 001	371
05 075651 001	407	05 078641 001	421	05 078720 001	424	05 104619 001	371
05 075652 001	407	05 078642 001	422	05 078721 001	424	05 104620 001	371
05 075653 001	408	05 078650 001	422	05 100000 001	58	05 104621 001	371
05 075654 001	408	05 078651 001	422	05 100001 001	58	05 104622 001	371
05 075655 001	408	05 078652 001	422	05 100002 001	58	05 104630 001	369
05 075656 001	409	05 078653 001	422	05 100003 001	58	05 104631 001	369
05 075657 001	409	05 078654 001	422	05 100004 001	58	05 104632 001	369
05 075670 001	411	05 078655 001	422	05 100011 001	59	05 104633 001	369
05 075670 010	411	05 078656 001	422	05 100012 001	59	05 104634 001	369
05 075671 001	411	05 078657 001	422	05 100015 001	59	05 104635 001	369
05 075671 010	411	05 078658 001	422	05 100016 001	59	05 104640 001	370
05 075672 001	412	05 078660 001	422	05 100019 001	60	05 104641 001	370
05 075672 010	412	05 078661 001	422	05 100020 001	60	05 104642 001	370
05 075673 001	412	05 078662 001	422	05 100021 001	60	05 104643 001	370
05 075673 010	412	05 078663 001	422	05 100022 001	60	05 104644 001	370
05 075680 001	404	05 078664 001	422	05 100024 001	61	05 104645 001	370
05 075681 001	404	05 078666 001	423	05 100025 001	61	05 104650 001	370
05 075800 001	395	05 078667 001	423	05 100026 001	61	05 104652 001	371
05 075801 001	395	05 078670 001	415	05 100030 001	12	05 104653 001	372
05 075810 001	391	05 078671 001	415	05 100031 001	12	05 104655 001	369
05 075815 001	392	05 078672 001	415	05 100042 001	12	05 104660 001	369
05 075830 001	396	05 078673 001	415	05 100043 001	12	05 104661 001	369
05 075831 001	396	05 078674 001	415	05 100044 001	12	05 104662 001	369
05 075832 001	397	05 078675 001	415	05 100050 001	13	05 104663 001	369
05 075840 001	391	05 078676 001	415	05 100051 001	13	05 104664 001	369
05 075850 001	393	05 078677 001	415	05 100052 001	13	05 104665 001	369
05 075851 001	392	05 078678 001	415	05 100055 001	14	05 104666 001	368
05 078200 001	419	05 078679 001	415	05 100056 001	14	05 104667 001	368
05 078205 001	420	05 078680 001	415	05 100057 001	14	05 104668 001	368
05 078210 001	420	05 078681 001	415	05 100060 001	16	05 104669 001	368
05 078345 001	420	05 078682 001	415	05 100061 001	16	05 104670 001	368
05 078600 001	414	05 078683 001	415	05 100062 001	16	05 104671 001	368
05 078601 001	414	05 078684 001	415	05 100063 001	16	05 104672 001	368
05 078602 001	414	05 078685 001	415	05 100064 001	16	05 104751 001	370
05 078603 001	414	05 078686 001	415	05 100070 001	17	05 104754 001	369
05 078604 001	414	05 078687 001	415	05 100071 001	17	05 105622 001	23
05 078605 001	414	05 078690 001	417	05 100072 001	17	05 105630 001	21
05 078606 001	414	05 078691 001	417	05 100075 001	9	05 105631 001	62
05 078607 001	414	05 078692 001	417	05 100076 001	9	05 105650 001	23
05 078608 001	414	05 078693 001	417	05 100077 001	9	05 105656 001	23
05 078609 001	414	05 078694 001	417	05 100080 001	9	05 110000 001	11

Code No.	Page	Code No.	Page	Code No.	Page	Code No.	Page
05 110001	001 11	05 118064	001 34	05 133157	001 205	05 134678	001 313
05 110002	001 11	05 118066	001 34	05 133158	001 205	05 134679	001 313
05 110003	001 11	05 118068	001 34	05 133163	001 197	05 134680	001 313
05 110004	001 11	05 118070	001 34	05 133164	001 194	05 134681	001 313
05 110005	001 11	05 118072	001 34	05 133165	001 194	05 134682	001 313
05 110006	001 11	05 118074	001 34	05 133180	001 200	05 134683	001 313
05 110007	001 11	05 118075	001 34	05 133285	001 10	05 134684	001 313
05 110008	001 11	05 118076	001 34	05 133355	001 65	05 134685	001 313
05 110010	001 12	05 118078	001 34	05 133356	001 64	05 134686	001 313
05 110011	001 12	05 118080	001 34	05 133862	001 160	05 134687	001 313
05 110104	001 12	05 118082	001 34	05 134000	001 36	05 134688	001 313
05 110105	001 12	05 118089	001 34	05 134001	001 29	05 134690	001 313
05 117680	001 17	05 118090	001 34	05 134002	001 29	05 134691	001 313
05 117681	001 17	05 118092	001 34	05 134011	001 278	05 134695	001 313
05 117682	001 17	05 118094	001 34	05 134013	001 245	05 134698	001 314
05 117683	001 17	05 118096	001 34	05 134015	001 246	05 134699	001 314
05 117684	001 17	05 118098	001 34	05 134019	001 50	05 134700	001 314
05 117685	001 17	05 118100	001 34	05 134021	001 372	05 134701	001 314
05 117686	001 17	05 118102	001 34	05 134025	001 279	05 134702	001 314
05 117687	001 17	05 118103	001 34	05 134200	001 357	05 134703	001 314
05 117691	001 17	05 118106	001 34	05 134275	001 26	05 134704	001 314
05 117990	001 32	05 118108	001 35	05 134370	001 291	05 134705	001 314
05 117991	001 32	05 118109	001 35	05 134371	001 291	05 134706	001 314
05 117992	001 32	05 118110	001 35	05 134372	001 291	05 134707	001 314
05 117993	001 32	05 118112	001 35	05 134373	001 291	05 134720	001 314
05 117994	001 32	05 118114	001 35	05 134374	001 305	05 134722	001 314
05 117995	001 32	05 118116	001 35	05 134375	001 305	05 134723	001 314
05 117997	001 32	05 118118	001 35	05 134376	001 305	05 134732	001 314
05 118000	001 32	05 118120	001 35	05 134377	001 305	05 134740	001 310
05 118002	001 32	05 118122	001 35	05 134378	001 305	05 134800	001 326
05 118003	001 32	05 118124	001 35	05 134379	001 305	05 134801	001 326
05 118004	001 32	05 118126	001 35	05 134380	001 292	05 134802	001 326
05 118005	001 32	05 118128	001 35	05 134381	001 292	05 134805	001 326
05 118006	001 32	05 118130	001 35	05 134382	001 292	05 134806	001 326
05 118007	001 32	05 118132	001 35	05 134384	001 301	05 134807	001 326
05 118008	001 32	05 118134	001 35	05 134385	001 301	05 134905	001 288
05 118010	001 32	05 118135	001 35	05 134386	001 301	05 134906	001 291
05 118012	001 32	05 118136	001 35	05 134397	001 339	05 134907	001 291
05 118014	001 32	05 118137	001 35	05 134398	001 339	05 134910	001 291
05 118017	001 32	05 118145	001 34	05 134399	001 341	05 134911	001 291
05 118019	001 33	05 118150	001 38	05 134480	001 338	05 134913	001 291
05 118020	001 33	05 118152	001 38	05 134491	001 221	05 134914	001 291
05 118022	001 33	05 118154	001 39	05 134605	001 294	05 134915	001 291
05 118023	001 33	05 118156	001 39	05 134609	001 313	05 134919	001 286
05 118024	001 33	05 118158	001 39	05 134654	001 314	05 134920	001 286
05 118026	001 33	05 118180	001 33	05 134655	001 314	05 134921	001 286
05 118030	001 32	05 118181	001 33	05 134656	001 314	05 134929	001 291
05 118032	001 32	05 118182	001 33	05 134657	001 314	05 134930	001 291
05 118035	001 33	05 118183	001 33	05 134658	001 314	05 134931	001 291
05 118036	001 33	05 118184	001 33	05 134664	001 313	05 134932	001 291
05 118037	001 33	05 118185	001 33	05 134665	001 313	05 135003	001 298
05 118039	001 33	05 118186	001 33	05 134667	001 313	05 135005	001 287
05 118040	001 33	05 130002	001 340	05 134668	001 313	05 135008	001 286
05 118042	001 33	05 130003	001 340	05 134669	001 313	05 135009	001 287
05 118044	001 33	05 130110	001 399	05 134670	001 313	05 135017	001 298
05 118046	001 33	05 133150	001 205	05 134671	001 313	05 135040	001 289
05 118048	001 33	05 133151	001 205	05 134672	001 313	05 135041	001 289
05 118050	001 33	05 133152	001 205	05 134673	001 313	05 135060	001 318
05 118052	001 33	05 133153	001 205	05 134674	001 313	05 135068	001 318
05 118054	001 33	05 133154	001 205	05 134675	001 313	05 135069	001 318
05 118060	001 34	05 133155	001 205	05 134676	001 313	05 135070	001 318
05 118062	001 34	05 133156	001 205	05 134677	001 313	05 135071	001 318

# Code No. Index

Code No.	Page	Code No.	Page	Code No.	Page	Code No.	Page
05 135072	001 318	05 135871	001 241	05 138257	001 16	05 203914	001 293
05 135073	001 318	05 135903	001 331	05 138258	001 16	05 204126	001 314
05 135074	001 318	05 135904	001 331	05 138259	001 16	05 221110	001 328
05 135075	001 318	05 135918	001 164	05 138260	001 16	05 223161	001 24
05 135076	001 318	05 135926	001 240	05 138261	001 16	05 259135	001 314
05 135077	001 318	05 135927	001 244	05 138262	001 16	05 300004	001 51
05 135078	001 318	05 135928	001 243	05 138263	001 16	05 308428	001 310
05 135079	001 318	05 135938	001 38	05 138264	001 16	05 311517	001 340
05 135090	001 321	05 135939	001 242	05 138265	001 16	05 319835	001 310
05 135091	001 321	05 135942	001 215	05 138266	001 16	05 320430	001 313
05 135092	001 321	05 135949	001 96	05 138268	001 16	05 320540	001 24
05 135093	001 321	05 135961	001 64	05 138269	001 16	05 323780	001 293
05 135094	001 321	05 135973	001 53	05 138270	001 16	05 323781	001 293
05 135095	001 321	05 136000	001 340	05 140310	001 255	05 324901	001 327
05 135096	001 321	05 136001	001 341	05 150101	001 259	05 326310	001 313
05 135097	001 321	05 136002	001 341	05 150102	001 260	05 328448	001 310
05 135098	001 321	05 136011	001 373	05 150103	001 260	05 332600	001 310
05 135099	001 321	05 136026	001 245	05 150104	001 261	05 332606	001 313
05 135120	001 313	05 136039	001 30	05 150105	001 261	05 332607	001 311
05 135121	001 313	05 136042	001 246	05 150106	001 262	05 332609	001 311
05 135140	001 306	05 136043	001 377	05 150110	001 262	05 332610	001 311
05 135141	001 306	05 136070	001 45	05 150111	001 263	05 340245	001 324
05 135142	001 306	05 136071	001 280	05 150112	001 263	05 340330	001 12
05 135143	001 306	05 136072	001 230	05 150113	001 264	05 344511	001 343
05 135200	001 310	05 136073	001 397	05 150114	001 264	05 344512	001 343
05 135201	001 310	05 136074	001 154	05 150115	001 265	05 344513	001 343
05 135202	001 310	05 136075	001 219	05 150116	001 265	05 344514	001 343
05 135204	001 310	05 136076	001 410	05 150120	001 266	05 344900	001 313
05 135205	001 310	05 136301	001 321	05 150121	001 266	05 345018	001 311
05 135220	001 311	05 136302	001 321	05 150122	001 267	05 345019	001 313
05 135221	001 311	05 136303	001 321	05 150123	001 267	05 345026	001 311
05 135222	001 311	05 136304	001 321	05 150124	001 268	05 345028	001 311
05 135224	001 331	05 136305	001 293	05 150130	001 258	05 345032	001 311
05 135225	001 331	05 136306	001 293	05 150140	001 268	05 345035	001 311
05 135230	001 313	05 136307	001 293	05 150150	001 269	05 345047	001 310
05 135231	001 313	05 136308	001 302	05 150151	001 270	05 345056	001 311
05 135232	001 313	05 136309	001 302	05 150152	001 271	05 345281	001 35
05 135233	001 313	05 136310	001 302	05 150180	001 272	05 345282	001 35
05 135234	001 313	05 136311	001 310	05 150181	001 272	05 345284	001 34
05 135235	001 313	05 136312	001 310	05 150182	001 272	05 345285	001 34
05 135264	001 316	05 136313	001 310	05 150183	001 273	05 345290	001 33
05 135265	001 316	05 136314	001 310	05 150184	001 273	05 345350	001 311
05 135266	001 316	05 136315	001 310	05 160785	001 97	05 345351	001 311
05 135267	001 316	05 136316	001 310	05 160821	001 314	05 345352	001 311
05 135268	001 322	05 136385	001 351	05 160830	001 310	05 346281	001 287
05 135269	001 322	05 136390	001 365	05 160885	001 321	05 346286	001 293
05 135270	001 294	05 136391	001 366	05 160895	001 294	05 346288	001 321
05 135271	001 294	05 136392	001 353	05 160896	001 292	05 346293	001 163
05 135272	001 294	05 136393	001 368	05 160899	001 292	05 347100	001 339
05 135273	001 294	05 136400	001 161	05 160901	001 294	05 347106	001 22
05 135276	001 294	05 136413	001 189	05 160908	001 294	05 347153	001 352
05 135277	001 294	05 136414	001 29	05 160917	001 313	05 347735	002 24
05 135280	001 295	05 136420	001 111	05 160924	001 339	05 347736	002 24
05 135281	001 295	05 136421	001 135	05 160956	001 313	05 347743	001 14
05 135284	001 295	05 136422	001 162	05 160976	001 339	05 347777	001 64
05 135285	001 295	05 136424	001 46	05 160977	001 339	05 347778	001 25
05 135311	001 27	05 136425	001 46	05 160979	001 339	05 350430	001 321
05 135530	001 293	05 136426	001 47	05 160981	001 339	05 350451	001 379
05 135531	001 293	05 136700	001 30	05 160983	001 291	05 380033	001 321
05 135532	001 293	05 138006	001 340	05 200496	001 311	05 380045	001 321
05 135810	001 359	05 138070	001 15	05 200995	001 166	05 380046	001 321
05 135870	001 241	05 138250	001 26	05 203913	001 293	05 380047	001 321

<b>Code No.</b>	<b>Page</b>	<b>Code No.</b>	<b>Page</b>	<b>Code No.</b>	<b>Page</b>	<b>Code No.</b>	<b>Page</b>
05 380048 001	321	05 380127 001	322	05 380200 001	293	05 670447 001	281
05 380049 001	321	05 380128 001	322	05 380201 001	293	05 670448 001	281
05 380050 001	321	05 380129 001	322	05 380202 001	293		
05 380124 001	322	05 380130 001	322	05 480172 001	287		
05 380125 001	322	05 380131 001	322	05 480222 001	298		
05 380126 001	322	05 380161 001	291	05 670446 001	281		

# Article No. Index

Article No.	Page	Article No.	Page	Article No.	Page
68	255	334 SK/6	22	454/7 HF Set 1	43
80	254	334/355 SK/6	23	454/7 HF Set 2	43
80 RA	251	335	11	454/10 HF Set Imperial 1	44
81	255	335 SB	12	454/10 HF Set Imperial 2	44
82	255	335/350/355/3	24	467 TORX® HF	40
83	255	335/350/355/4	24	467/7 TORX® HF Set 1	45
84	255	335/350/355/6	23	467/7 TORX® HF Set 2	45
85	255	335/350/367/7	24	495	41
86	255	335 Stubby	19	712	254
87	255	338	18	780 A	343
88/1	253	338/2	26	780 B	343
91	254	350 PH	13	780 C	343
95 Vario	254	350 SB	13	781 A	342
160 i VDE	58	350 SK	13	781 B	342
160 i VDE SB	58	350 PH Stubby	20	781 C	342
160 i/162 i/167 i/9	65	352	15	781/5 Set 1	342
160 i/165 i/7 Rack	63	354	14	784 A/1	343
160 i/168 i/6 Rack	64	355 PZ	14	784 B	343
160 i/6 Rack	63	355 SB	14	784 C	343
160 i/7 Rack	63	355 SK	13	800 S	233
160 iS VDE	58	355 Stubby	20	800/1 BDC	314
160 iS/7	64	367 TORX®	16	800/1 BTZ	315
160 iSS	58	367 TORX® SB	16	800/1 TZ	315
160 iSS/7	64	367/6 TORX®	25	800/1 Z	315
162 i VDE PH	59	367 TORX® BO	16	800/2 Z	316
162 i VDE PH SB	59	367/6 TORX® BO	26	800/4 Z	316
162 iS PH VDE	59	367 TORX® HF	15	800/9 C	316
162 iS PH/S VDE	60	367/4 TORX® HF	25	809/1 ESD Stubby	55
162 iSS PH VDE	59	367/6 TORX® HF	25	810/1 Vario	250
162 i PH/S VDE	60	367/7 TORX® HF	24	811/1 ESD Stubby	55
162 i PH/S VDE SB	60	367 TORX® Stubby	20	811/1 Stubby	250
165 i PZ VDE	59	367 TORX PLUS®	17	812/1 Vario	250
165 i PZ VDE SB	59	368	17	813	250
165 iS PZ VDE	60	368 SB	17	813 R	249
165 i PZ/S VDE	60	368 Stubby	20	813 R ESD	52
165 i PZ/S VDE SB	60	391	18	816 R	249
165 iS PZ/S VDE	61	391/3	27	816 R SB	249
165 iS PZ/S VDE # 1 + 2	65	392	249	816 R ESD	52
165 iSS PZ/S VDE	61	393 S	249	816 RA	251
167 i TORX® VDE	61	395	18	817 R	248
167 i/6 TORX® VDE	64	395 HO	19	817 R SB	248
168 i VDE	61	395 HO/3	26	817 VDE	78
168 i VDE SB	61	395 HO/7 SM	26	826 T Kraftform Turbo	215
190 i VDE	62	400 Hex	394	827 T Kraftform Turbo	79
247	62	400 i Hex	91	830	254
247 SB	62	400 TX	394	837 i RA	69
300 Hex	393	410 i VDE B	86	838 RA S	247
300 IP	394	411 A RA	42	838 RA-R M	247
300 TX	393	416 R	41	840 S	233
334	12	416 RA	42	840/1 BTZ	318
334 SB	12	454	39	840/1 IMP DC DIY	317
334/6	23	454 Imperial	40	840/1 IMP DC SB	317
334/355/6 Rack	23	454 HF	40	840/1 Z	318
334/368/6	25	454 Imperial HF	40	840/1 Z SB	319
334 SK	12	454/5 HF SHK Set 1	45	840/2 Z	322

Article No.	Page	Article No.	Page	Article No.	Page
840/4 IMP DC DIY	319	851/4 TZ SB	292	867/1 TORX® DIY	307
840/4 IMP DC SB	320	851/4 Z	292	867/1 TORX® DIY 100	307
840/4 Z	321	851/4 Z SB	293	867/1 TORX® HF	305
840/4 Z SB	321	851/9 C	294	867/1 TORX® SB	306
840/9 C	322	851/11	294	867/1 TZ TORX®	306
840/1 Z BO	322	851/12	294	867/1 Z TORX® W	307
840/4 Z BO	323	851/16	294	867/1 ZA TORX®	308
842/1 Z	319	851/21 J	295	867/2 Z TORX®	311
842/4	322	851/4 PH/S	302	867/4 IMP DC TORX® DIY	308
843	368	853/1 TZ ACR®	288	867/4 IMP DC TORX® SB	308
844	368	853/4 ACR®	293	867/4 Z TORX®	310
844/7	369	853/4 ACR® Harpoon	294	867/4 Z TORX® SB	310
845	369	853/4 ACR® SL	293	867/4 TORX® HF	309
845/8	369	855 S	232	867/4 TORX® KK	309
846 HSS	369	855/1 BDC	296	867/9 C TORX®	311
846/8	370	855/1 BDC SB	297	867/12 TORX®	311
847 HSS	370	855/1 BTH	297	867/15 TORX®	311
847/7 HSS	370	855/1 BTZ	297	867/1 Z TORX® BO	311
848 HSS	371	855/1 IMP DC DIY	295	867/1 Z TORX® BO SB	312
848/851/867/19	371	855/1 IMP DC SB	295	867/4 Z TORX® BO	312
849 HSS	371	855/1 RZ	298	867/4 Z TORX® BO SB	313
849/855/867/18	372	855/1 TH	298	867/4 IP TORX PLUS®	313
851 S	232	855/1 TH SB	298	867/4 IPR TORX PLUS®	314
851/1 A	286	855/1 TiN	298	867/9 C IP TORX PLUS®	313
851/1 BDC	285	855/1 TZ	298	868 S	233
851/1 BDC SB	285	855/1 Z	298	868/1 IMP DC DIY	324
851/1 BTH	285	855/1 Z DIY	299	868/1 IMP DC SB	324
851/1 BTZ	286	855/1 Z DIY 100	299	868/1 V	324
851/1 IMP DC DIY	284	855/1 Z SB	299	868/1 Z	325
851/1 IMP DC SB	284	855/2 Z	302	868/1 Z SB	325
851/1 J	289	855/4 BDC	300	868/4	326
851/1 RDC	286	855/4 BTH	300	868/4 SB	326
851/1 RH	287	855/4 BTZ	301	868/4 BTZ	326
851/1 RZ	287	855/4 IMP DC DIY	299	868/4 IMP DC DIY	325
851/1 RZ SB	287	855/4 IMP DC SB	300	868/4 IMP DC SB	326
851/1 TH	287	855/4 TH	301	868/4 V	327
851/1 TiN	287	855/4 TZ	301	869/4	329
851/1 TZ	288	855/4 TZ SB	301	869/4 M	330
851/1 TZ SB	288	855/4 Z	302	869/4 M SB	330
851/1 Z	288	855/4 Z SB	302	869/4 M SB Set A	331
851/1 Z DIY	288	855/11	302	869/9	331
851/1 Z DIY 100	289	855/12	302	870/1	340
851/1 Z SB	288	855/4 PZ/S	303	870/2	341
851/2 Z	294	857/1 Z	329	870/4	341
851/4 A	291	857/4 Z	329	870/4 A	340
851/4 BDC	290	860/1 XZN	328	870/4 SB	341
851/4 BTH	291	867 S TORX®	232	870/4/7 Set A SB	341
851/4 BTZ	291	867/1 IMP DC TORX® DIY	303	870/7	341
851/4 IMP DC DIY	289	867/1 IMP DC TORX® SB	303	870/14	341
851/4 IMP DC SB	290	867/1 IP TORX PLUS®	313	871/1 TORQ-SET® Mplus 25 mm	327
851/4 J	293	867/1 IPR TORX PLUS®	314	871/1 TORQ-SET® Mplus 32 mm	327
851/4 R	292	867/1 TORX®	306	871/2 TORQ-SET® Mplus	328
851/4 RH	291	867/1 TORX® BDC	305	871/4 TORQ-SET® Mplus	328
851/4 TH	292	867/1 TORX® BDC SB	305	871/1 DC TORQ-SET® Mplus	327
851/4 TZ	292	867/1 TORX® BTZ	305	871/4 DC TORQ-SET® Mplus	327

# Article No. Index

Article No.	Page	Article No.	Page	Article No.	Page
872/9	328	950 PKS	205	1013 Krafftform Micro	35
875/1 TRI-WING® 25 mm	328	950 SPKL HF Multicolour	202	1013 Krafftform Micro ESD	51
875/4 TRI-WING®	328	950 SPKL Multicolour	203	1060 i VDE	84
879/4	331	950 SPKL Multicolour Imperial	203	1060 i/1062 i/6 VDE	85
881/4/1 SB	340	950 SPKS Multicolour	203	1060 i/1065 i/6 VDE	85
887/4 RR	336	950 SPKS Multicolour Imperial	203	1062 i PH VDE	85
887/4 RR SB	336	950/7 Hex-Plus 1	198	1065 i PZ VDE	85
888/4/1 K	336	950/7 Hex-Plus Magnet 1	198	1267 A TORX®	28
889/4 R	336	950/7 Hex-Plus Multicolour Magnet 1	196	1267 B TORX®	28
889/4/1	336	950/9 Hex-Plus 1	196	1267 A TORX PLUS®	28
889/4/1 F	337	950/9 Hex-Plus 1 SB	196	1267 B TORX PLUS®	28
889/4/1 K	336	950/9 Hex-Plus 2	196	1427	29
889/4/1 K SB	336	950/9 Hex-Plus 3	197	1428	29
890/4/1	338	950/9 Hex-Plus 4	197	1429	35
893/4/1 K	338	950/9 Hex-Plus 5	197	1430 ESD	380
893/4/1 K SB	338	950/9 Hex-Plus 6	197	1440/1442	30
894/4/1	337	950/9 Hex-Plus 6 SB	197	1441	30
894/4/1 K	337	950/9 Hex-Plus 7	197	1460 ESD	385, 389
895/4/1	337	950/9 Hex-Plus 8	198	1529 ESD	49
895/4/1 K	337	950/9 Hex-Plus Imperial 1	200	1550 PH ESD Micro	47
895/4/1 K SB	337	950/9 Hex-Plus Imperial 1 SB	200	1550/6 ESD Micro	51
896/4/1 SB	340	950/9 Hex-Plus Multicolour 1	193	1550 PH S ESD Micro	48
897/4 IMP R	334	950/9 Hex-Plus Multicolour 1 SB	194	1555 ESD PZ Micro	48
897/4 Impaktor	334	950/9 Hex-Plus Multicolour 2	194	1567 ESD TORX® Micro	48
897/4 Impaktor R	334	950/9 Hex-Plus Multicolour 3	194	1567 ESD TORX® HF Micro	48
897/4 R	335	950/9 Hex-Plus Multicolour HF 1	193	1567 ESD TORX® BO Micro	48
897/4 R SB	335	950/9 Hex-Plus Multicolour Imperial 1	195	1567 ESD TORX PLUS® IPR Micro	48
898/4	338	950/9 Hex-Plus Multicolour Imperial 2	195	1569 ESD Micro	49
898/9	338	950/9 Hex-Plus Multicolour Imperial 3	195	1572 ESD Micro	49
898/21	338	950/9 L Hex-Plus HF 1	196	1573 ESD Micro	49
899/3/1	339	950/13 Hex-Plus Imperial 1	199	1578 A ESD Micro	47
899/4/1	339	950/13 Hex-Plus Imperial 1 SB	199	1578 A/6 ESD Micro	51
899/4/1 SB	339	967 TORX®	211	2035 Micro	32
899/4/1 S	339	967 L TORX® HF	211	2035/6 A Micro	38
899/14/1 SB	339	967 PKL TORX®	211	2035/6 B Micro	38
917 SPH	9	967 PKXL TORX®	210	2050 Micro	33
917 SPH SB	9	967 SL TORX® HF	209	2050/6 Micro	38
917 SPHS	9	967 SPKXL TORX® Multicolour	209	2052 Micro	34
918 SPZ	9	967 SXL HF TORX® Multicolour	209	2052/6 Micro	39
918 SPZ SB	9	967 SXL TORX® Multicolour	210	2054 Micro	34
921	232	967 XL HF TORX®	210	2055 Micro	32
932 A	8	967 XL TORX®	211	2067 TORX® Micro	33
932 A SB	8	967/9 TX 1	208	2067 TORX® Micro HF	33
932 AS	8	967/9 TX 1 SB	208	2067 TORX® BO Micro	33
932/6	10	967/9 TX HF 1	207	2067/6 TORX® BO Micro	39
932 S/6	10	967/9 TX Multicolour HF 1	207	2067 TORX PLUS® IPR Micro	33
932/918/6	10	967/9 TX XL 1	208	2069 Micro	35
950	205	967/9 TX XL HF 1	207	2069/6 Micro	39
950 BM	206	967/9 TX XL Multicolour 1	207	2072 Micro	34
950 L	205	967/9 TX XL Multicolour HF 1	207	2090	426
950 L HF	205	967 SPKL TORX® BO Multicolour	210	2090/17	426
950 PKL	204	967/9 TORX® BO Multicolour 1	208	3160 i VDE	56
950 PKL BM	204	967/9 TORX® BO Multicolour 1 SB	208	3160 i/7 Rack	57
950 PKL Imperial	204	977 TORX®	9	3162 i VDE	56
950 PKLS	204	977/6 TORX®	11	3165 i VDE	56



Article No.	Page	Article No.	Page	Article No.	Page
3165 i/6 Rack	57	6001 Joker Switch 11 Set 1	180	7774/3	422
3167 i VDE TORX®	57	6002 Joker Double	181	7775	422
3167 i/7 Rack	57	6003 Joker	181, 182	7776	422
3334	6	6003 Joker 4 Set 1	185	7779/1	423
3334/6	7	6003 Joker 4 Imperial Set 1	186	7779/2	423
3334/3350/3355/6	8	6003 Joker 5 Set 1	183	7780	415
3334/3355/6	7	6003 Joker 5 Imperial Set 1	185	7781	417
3335	6	6003 Joker 8 Imperial Set 1	183	7782 C	419
3350 PH	6	6003 Joker Pedal	182	7782 E	419
3355 PZ	7	6003 Joker 11 Set 1	183	7783 C	420
3367	7	6003 Joker 15 Set 1	183	7783 E	421
3368	7	6003 Joker 22 Set 1	182	7786	423
3800/4	315	6004 Joker L	188	7790/1	424
3816 R	248	6004 Joker M	187	7790/2	424
3817 VDE Stainless	66	6004 Joker S	187	7880 Joker L	414
3840/1 TS	317	6004 Joker XL	188	7880 Joker XL	413
3840/4	320	6004 Joker XS	187	7880 Joker XXL	413
3851/1 TS PH	284	6004 Joker XXL	188	8000 A	98
3851/1 TS PH SB	285	6004 Joker 4 Set 1	188	8000 A SB	98
3851/4 PH	290	6004 Joker VDE L	91	8000 B	115
3855/1 TS PZ	296	6004 Joker VDE M	91	8000 B SB	116
3855/1 TS PZ SB	296	6004 Joker VDE S	91	8000 C	138
3855/4 PZ	300	6004 Joker VDE XS	90	8000 C SB	138
3867/1 TS TORX®	304	6004 Joker VDE 4 Set 1	90	8000 E	161
3867/1 TS TORX® SB	304	6005 Joker 4 Set 1	189	8001 A SB	172
3867/4 TORX® BO	312	6005 Joker Double	189	8002 C KOLOSS All Inclusive Set	160
3868/4	326	7400	376, 381, 382, 383, 386, 387, 388	8002 C KOLOSS Set	160
3869/4	329			8003 A	100
3888/4/1 K	335			8003 B	119
3888/4/1 K SB	335	7400 ESD	380, 383, 384, 389,390	8003 C	141
3950 PKL	202			8004 A	101
3950 PKL Imperial	202	7400 VDE	77	8004 B	121
3950 SPKL Multicolour	201	7440/41	378	8004 C	142
3950 SPKL Multicolour HF	201	7440/41/42	379	8005	172
3950 SPKL Multicolour Imperial	202	7443/12	378	8006 C	139
3950/9 Hex-Plus Imperial Stainless 1	193	7443/61/9	379	8006 SC 1	139
3950/9 Hex-Plus Multicolour HF		7445/46/47	379	8007 B VDE	87
Stainless 1	192	7510	391	8008 A	173
3950/9 Hex-Plus Multicolour Imperial		7510/14	391	8009 Zyklop Pocket Set 1	156
Stainless 1	195	7515	392	8009 Zyklop Pocket Set 2	157
3950/9 Hex-Plus Multicolour Stainless 1	192	7515/7	393	8009 Zyklop Pocket Set 3	159
3950/9 Hex-Plus Stainless 1	192	7515/16	392	8009 Zyklop Pocket Set 4	159
3950/9 Hex-Plus Stainless 1 SB	193	7761	425	8009 Zyklop Pocket Imperial Set 1	156
3967 SXL HF TORX® Multicolour	209	7762	425	8009 Zyklop Pocket Imperial Set 2	158
3967/9 TX SXL Multicolour HF Stainless 1	207	7763	425	8010 B	117
6000 Joker	176	7770	414	8100 SA All-In	94
6000 Joker 4 Imperial Set 1	179	7771	416	8100 SA 2	96
6000 Joker 4 Set 1	178	7772 A	418	8100 SA 4	97
6000 Joker 8 Imperial Set 1	178	7772 B	418	8100 SA 6	95
6000 Joker 11 Set 1	178	7772 C	418	8100 SA 7	99
6000/6002 Joker 6 Set 1	178	7773 A	419	8100 SA 8	100
6001 Joker Switch	179	7773 B	420	8100 SA 9	95
6001 Joker Switch 4 Set 1	180	7773 C	420	8100 SA 10	99
6001 Joker Switch 4 Imperial Set 1	180	7774/1	421	8100 SA 11	101
6001 Joker Switch 8 Imperial Set 1	180	7774/2	421	8100 SA 12 HF	101

# Article No. Index

Article No.	Page	Article No.	Page	Article No.	Page
8100 SA/SC 2	97	8789 B	134	9602	162
8100 SB All-in	112	8789 C	155	9604	46
8100 SB HF 1	121	8790 B Impaktor	122	9605	46
8100 SB VDE 1	86	8790 B VDE	88	9606	47
8100 SB 2	114	8790 C HF 1	147	9607	123
8100 SB 4	114	8790 C Impaktor	142	9608	124
8100 SB 6	113	8790 C Impaktor Deep	144	9610	189
8100 SB 7	118	8790 C Impaktor Deep Set 1	144	9611	29
8100 SB 8	120	8790 C Wheel Impaktor	147	9630	177
8100 SB 9	113	8790 FA	173	9631	177
8100 SB 10	119	8790 HMA	102	9632	177
8100 SB 11	121	8790 HMA Deep	105	9640	186
8100 SB 12	116	8790 HMA HF	102	9641	186
8100 SB 13	117	8790 HMB	122	9642	186
8100 SC 2	137	8790 HMB Deep	126	9650	20
8100 SC 4	138	8790 HMB HF	123	9700	258
8100 SC 6	136	8790 HMC	145	9710	259
8100 SC 7	140	8790 HMC Deep	148	9711	260
8100 SC 8	141	8790 HMC Deep Open	149	9712	260
8100 SC 9	137	8790 HMC HF	145	9713	261
8100 SC 10	141	8794 A	111	9714	261
8100 SC 11	142	8794 B	134	9715	262
8700 A FL	109	8794 C	155	9720	262
8740 A	108	8794 LA	110	9721	263
8740 A HF	108	8794 LB	134	9722	263
8740 A HF 1	109	8794 LB VDE	89	9723	264
8740 B	130	8794 LC	154	9724	264
8740 B HF	130	8794 SA	110	9725	265
8740 B HF 1	131	8794 SB	134	9726	265
8740 B HF Imperial 1	132	8794 SB VDE	89	9730	266
8740 B VDE HF	88	8794 SC	155	9731	266
8740 C HF	152	8795 A	110	9732	267
8740 C HF 1	153	8795 B	134	9733	267
8740 C HF 2	153	8795 C	155	9734	268
8751 A	109	8796 LA	109	9740	268
8755 A	109	8796 LB	133	9750	269
8760 B VDE XZN	88	8796 LC	154	9751	270
8767 A	106	8796 SA	110	9752	271
8767 A HF	106	8796 SB	133	9780	272
8767 A HF 1	107	8796 SC	154	9781	272
8767 B	128	8797 C	140	9782	272
8767 B HF	128	9100	246	9783	273
8767 B HF 1	129	9108/2	30	9784	273
8767 B VDE HF	88	9200	340	Belt A 0/8	111
8767 C HF	150	9500	29	Belt A 0/9	111
8767 C HF 1	151	9506 SB	323	Belt A 1	103
8767 C HF 2	151	9507 SB	323	Belt A 2	108
8767 C HF 3	152	9514 ESD	55	Belt A 3	107
8780 C	161	9523	30	Belt A 4	103
8781 C	161	9524	377	Belt A Deep 1	105
8782 C	161	9529 C SB	154	Belt A Imperial 1	104
8784 A1	111	9530	410	Belt B 0/8	135
8784 B1	134	9532	246	Belt B 0/9	135
8784 C2	155	9600	111	Belt B 1	124
8789 A	110	9601	135	Belt B 2	131

Article No.	Page	Article No.	Page	Article No.	Page
Belt B 3	129	Bit-Check 6 V Universal 1	362	Bit-Check 30 Metal 1 SB	367
Belt B 4	125	Bit-Check 6 Wood TX HF 1	366	Bit-Check 30 Stainless 1	349
Belt B Deep 1	127	Bit-Check 6 Wood TX HF 1 SB	366	Bit-Check 30 TX Universal 1	356
Belt B Imperial 1	132	Bit-Check 7 Diamond 1	353	Bit-Check 30 TX Universal 1 SB	356
Belt B VDE 0/10	89	Bit-Check 7 Diamond 1 SB	354	Bit-Check 30 Universal 1	356
Belt B VDE 1	87	Bit-Check 7 Hex-Plus 1	360	Bit-Check 30 Wood 1	363
Belt C 0/ 6	161	Bit-Check 7 PZ Diamond 1	354	Bit-Check 30 Wood 2	364
Belt C 1	146	Bit-Check 7 PZ Universal 1	359	Bit-Check 30 Wood 2 SB	364
Belt C 2	153	Bit-Check 7 TX BO Universal 1	360	Bit-Check 30 Wood TX HF 1	363
Belt C 3	150	Bit-Check 7 TX Diamond 1	354	Bit-Check 30 Wood TX HF 1 SB	363
Belt C Deep 1	149	Bit-Check 7 TX Universal 1	360	Bit-Check 30 Zyklop Mini 1	163
Belt C Impaktor 0/9	162	Bit-Check 7 TX Universal 1 SB	360	Bit-Check 30 Zyklop Mini 2	163
Belt C Impaktor 1	143	Bit-Check 7 Universal 1	359	Bit-Safe 43 Universal 1	355
Bicycle Big Pack 1	28	Bit-Check 7 Universal 1 SB	359	Bit-Safe 61 BiTorsion 1	350
Bicycle Set 1	168	Bit-Check 7 Universal 4	359	Bit-Safe 61 Universal 1	355
Bicycle Set 2	225	Bit-Check 10 BiTorsion 1	352	Click-Torque A 5	398
Bicycle Set 3	169	Bit-Check 10 BiTorsion 3 SB	352	Click-Torque A 6	398
Bicycle Set 3 A	170	Bit-Check 10 Drywall 1	373	Click-Torque A 6 Set 1	399
Bicycle Set 4	200	Bit-Check 10 Impaktor 1	346	Click-Torque B 1	401
Bicycle Set 5	239	Bit-Check 10 Impaktor 1 SB	347	Click-Torque B 2	401
Bicycle Set 6	46	Bit-Check 10 Impaktor 2	347	Click-Torque C 1	402
Bicycle Set 7	115	Bit-Check 10 Impaktor 3	347	Click-Torque C 2	402
Bicycle Set 8	133	Bit-Check 10 Impaktor 4	347	Click-Torque C 2 Push R/L	406
Bicycle Set 9	171	Bit-Check 10 PZ BiTorsion 2	352	Click-Torque C 3	403
Bicycle Set 10	184	Bit-Check 10 PZ Impaktor 1	347	Click-Torque C 3 Push R/L	406
Bicycle Set 11	239	Bit-Check 10 Stainless 1	349	Click-Torque C 3 Set 1	404
Bicycle Set 12	184	Bit-Check 10 Stainless 1 SB	349	Click-Torque C 3 Set 2	404
Bicycle Set 13	31	Bit-Check 10 TX Impaktor 1	347	Click-Torque C 4	405
Bicycle Set 15	31	Bit-Check 10 TX Universal 1	358	Click-Torque C 5	405
Bicycle Set Torque 1	400	Bit-Check 10 TX Universal 2	358	Click-Torque E 1	405
Bit-Box 15 Impaktor PH	284	Bit-Check 10 Universal 1	357	Click-Torque E 1 Push R/L	407
Bit-Box 15 Impaktor PZ	295	Bit-Check 10 Universal 2	357	Click-Torque X 1	407
Bit-Box 15 Impaktor TX	303	Bit-Check 10 Universal 3	357	Click-Torque X 2	407
Bit-Box 20 BTH PZ	297	Bit-Check 10 Universal 3 SB	357	Click-Torque X 3	408
Bit-Box 20 BTZ PH	286	Bit-Check 10 Universal 4	358	Click-Torque X 4	408
Bit-Box 20 BTZ PZ	297	Bit-Check 10 Universal 5 SB	358	Click-Torque X 5	408
Bit-Box 20 PH	289	Bit-Check 10 Zyklop Mini 1	167	Click-Torque X 6	409
Bit-Box 20 PZ	299	Bit-Check 10 Zyklop Mini BiTorsion 1	167	Click-Torque X 7	409
Bit-Box 20 TX	307	Bit-Check 12 BiTorsion 1	351	Click-Torque XP 1	411
Bit-Box 20 TX HF	306	Bit-Check 12 BiTorsion 1 SB	351	Click-Torque XP 2	411
Bit-Box 20 V Robertson	324	Bit-Check 12 Diamond 1	353	Click-Torque XP 3	412
Bit-Check 6 Impaktor 1	348	Bit-Check 12 Diamond 1 SB	353	Click-Torque XP 4	412
Bit-Check 6 Impaktor 1 SB	348	Bit-Check 12 Metal 1	368	K 50	281
Bit-Check 6 PH Impaktor 1	348	Bit-Check 12 Metal 1 SB	368	K 70	281
Bit-Check 6 PZ Impaktor 1	348	Bit-Check 12 Wood 1	365	K 120	281
Bit-Check 6 PZ Universal 1	362	Bit-Check 12 Wood 1 SB	365	Kraftform 2go 100	63
Bit-Check 6 SHK 1 SB	373	Bit-Check 12 Wood 2	365	Kraftform 2go 300	22
Bit-Check 6 Stainless 1	349	Bit-Check 12 Wood 2 SB	366	Kraftform Big Pack 100 VDE	62
Bit-Check 6 TX Impaktor 1	348	Bit-Check 12 Wood TX HF 1	364	Kraftform Big Pack 300	21
Bit-Check 6 TX Universal 1	362	Bit-Check 12 Wood TX HF 1 SB	365	Kraftform Big Pack 900	10
Bit-Check 6 TX Universal 1 SB	362	Bit-Check 30 BiTorsion 1	351	Kraftform Kompakt 10	215
Bit-Check 6 Universal 1	361	Bit-Check 30 Diamond 1	353	Kraftform Kompakt 12	215
Bit-Check 6 Universal 1 SB	361	Bit-Check 30 Impaktor 1	346	Kraftform Kompakt 20	217
Bit-Check 6 Universal 2	361	Bit-Check 30 Impaktor 2	346	Kraftform Kompakt 20 Tool Finder 1	216
Bit-Check 6 Universal 2 SB	361	Bit-Check 30 Metal 1	367	Kraftform Kompakt 20 Tool Finder 2	217

# Article No. Index

Article No.	Page	Article No.	Page	Article No.	Page
Kraftform Kompakt 25	218	Kraftform Kompakt Pistol RA 4	252	Kraftform Kompakt VDE 62 i PH/S Take it easy	81
Kraftform Kompakt 26	218	Kraftform Kompakt SH 1	244	Kraftform Kompakt VDE 62 iS PH/S	
Kraftform Kompakt 27 Set 1	219	Kraftform Kompakt SH 2	245	Take it easy	81
Kraftform Kompakt 27 Set 2	220	Kraftform Kompakt Stubby 1	238	Kraftform Kompakt VDE 64 i Take it easy	83
Kraftform Kompakt 27 Imperial Set 1	220	Kraftform Kompakt Stubby ESD 1	54	Kraftform Kompakt VDE 64 i Take it easy SB	83
Kraftform Kompakt 27 XL SHK 1	219	Kraftform Kompakt Stubby Magazin 1	237	Kraftform Kompakt VDE 65 i Take it easy	80
Kraftform Kompakt 27 XL Universal 1	218	Kraftform Kompakt Stubby Magazin 2	237	Kraftform Kompakt VDE 65 iS Take it easy	81
Kraftform Kompakt 27 XL Universal Imperial Set 1	219	Kraftform Kompakt Stubby Magazin 3	237	Kraftform Kompakt VDE 65 iS Take it easy SB	81
Kraftform Kompakt 27 RA 1 SB	253	Kraftform Kompakt Stubby Magazin 4	237	Kraftform Kompakt VDE 65 i PZ/S Take it easy	81
Kraftform Kompakt 27 RA 2 SB	253	Kraftform Kompakt Stubby Magazin 5	237	Kraftform Kompakt VDE 65 iS PZ/S	
Kraftform Kompakt 28	221	Kraftform Kompakt Stubby Magazin RA 1	236	Take it easy	82
Kraftform Kompakt 28 SB	220	Kraftform Kompakt Stubby Magazin RA 2	236	Kraftform Kompakt VDE 65 iS PZ/S	
Kraftform Kompakt 28 Imperial 1	220	Kraftform Kompakt Stubby Magazin RA 4	236	Take it easy SB	82
Kraftform Kompakt 40	221	Kraftform Kompakt Turbo 1	214	Kraftform Kompakt VDE 67 i TORX®	
Kraftform Kompakt 41	221	Kraftform Kompakt Turbo Imperial 1	214	Take it easy	82
Kraftform Kompakt 60	223	Kraftform Kompakt Turbo i 1 Tool Finder	78	Kraftform Kompakt VDE 67 i TORX®	
Kraftform Kompakt 60 ESD	52	Kraftform Kompakt Turbo i Imperial 1		Take it easy SB	82
Kraftform Kompakt 60 Imperial	224	Tool Finder	79	Kraftform Kompakt VDE 67 iS Take it easy	83
Kraftform Kompakt 60 KK	224	Kraftform Kompakt Vario RA	252	Kraftform Kompakt VDE 68 i Take it easy	83
Kraftform Kompakt 60 RA	251	Kraftform Kompakt VDE 7 extra slim 1		Kraftform Kompakt VDE 68 iS Take it easy	83
Kraftform Kompakt 60 RA Imperial	251	Tool Finder	76	Kraftform Kompakt VDE 3060 i	
Kraftform Kompakt 60 Stainless	222	Kraftform Kompakt VDE 7 Imperial 1		Take it easy SB	67
Kraftform Kompakt 60 Stainless Imperial	223	Tool Finder	77	Kraftform Kompakt VDE 3060 iS	
Kraftform Kompakt 60 Torque	222	Kraftform Kompakt VDE 7 Universal 1		Take it easy SB	67
Kraftform Kompakt 62	225	Tool Finder	77	Kraftform Kompakt VDE 3062 iS	
Kraftform Kompakt 70 Universal	226	Kraftform Kompakt VDE 7 Universal 2		Take it easy SB	67
Kraftform Kompakt 71 Security	226	Tool Finder	77	Kraftform Kompakt VDE 3065 iS PZ	
Kraftform Kompakt 96 VK 6,3	84	Kraftform Kompakt VDE 15 Torque		Take it easy SB	68
Kraftform Kompakt 97 VK 8,1	84	1,2-3,0 Nm extra slim 1 Tool Finder	71	Kraftform Kompakt VDE 3065 iS PZ/S	
Kraftform Kompakt 98 DK	84	Kraftform Kompakt VDE 16 extra slim 1		Take it easy SB	68
Kraftform Kompakt 99 FL	84	Tool Finder	75	Kraftform Kompakt VDE 3067 i TORX®	
Kraftform Kompakt 100	227	Kraftform Kompakt VDE 16 Torque		Take it easy SB	69
Kraftform Kompakt 400	228	1,2-3,0 Nm extra slim 1 Tool Finder	71	Kraftform Kompakt VDE 3067 iS TORX®	
Kraftform Kompakt 400 RA Set 1	228	Kraftform Kompakt VDE 16 Universal 1		Take it easy SB	68
Kraftform Kompakt 400 RA Set 2	229	Tool Finder	76	Kraftform Kompakt VDE Big Pack 1	72
Kraftform Kompakt 400 RA Imperial Set 1	229	Kraftform Kompakt VDE 17 extra slim 1		Kraftform Kompakt VDE Stainless 8	
Kraftform Kompakt 400 RA Imperial Set 2	230	Tool Finder	74	extra slim 1 Tool Finder	66
Kraftform Kompakt 400 RA SHK Set 1	230	Kraftform Kompakt VDE 17 RA 1	70	Kraftform Kompakt VDE Stainless 17	
Kraftform Kompakt 838 RA S Set 1	234	Kraftform Kompakt VDE 17 RA Imperial 1	70	extra slim 1 Tool Finder	65
Kraftform Kompakt 838 RA S Imperial Set 1	234	Kraftform Kompakt VDE 17 Universal 1		Kraftform Kompakt W 1	240
Kraftform Kompakt 838 RA-R M Set 1	235	Tool Finder	75	Kraftform Kompakt W 2	241
Kraftform Kompakt 838 RA-R M Imperial Set 1	235	Kraftform Kompakt VDE 18 Imperial 1		Kraftform Kompakt W Imperial 1	241
Kraftform Kompakt 900	231	Tool Finder	73	Kraftform Kompakt Zyklop	98
Kraftform Kompakt 900 Imperial Set 1	231	Kraftform Kompakt VDE 18 Universal 1		Kraftform Kompakt Zyklop Mini 2	164
Kraftform Kompakt F 1	245	Tool Finder	73	Kraftform Kompakt Zyklop MS1	
Kraftform Kompakt H 1	242	Kraftform Kompakt VDE 18 Universal 2		Metal/Speed 1/4"	96
Kraftform Kompakt M 1	243	Tool Finder	74	Kraftform Micro Big Pack 1	36
Kraftform Kompakt Micro 11 Electronics 1	37	Kraftform Kompakt VDE 60 i Take it easy	79	Kraftform Micro ESD Big Pack 1	50
Kraftform Kompakt Micro 11 ESD 1	54	Kraftform Kompakt VDE 60 i Take it easy SB	79	Kraftform Micro 12 Electronics 1	37
Kraftform Kompakt Micro 11 Universal 1	38	Kraftform Kompakt VDE 60 iS Take it easy	80	Kraftform Micro 12 Universal 1	36
Kraftform Kompakt Micro 20 ESD 1	53	Kraftform Kompakt VDE 60 iS Take it easy SB	80	Kraftform XXL	21
Kraftform Kompakt Micro 21 ESD 1	53	Kraftform Kompakt VDE 62 i Take it easy	80	Kraftform XXL 2	22
Kraftform Kompakt Pistol RA	252	Kraftform Kompakt VDE 62 iS Take it easy	80	Kraftform XXL 3	22
		Kraftform Kompakt VDE 62 iS Take it easy SB	80	M 1	103
				Magnetic Socket Rail A 4	104

<b>Article No.</b>	<b>Page</b>	<b>Article No.</b>	<b>Page</b>	<b>Article No.</b>	<b>Page</b>
Magnetic Socket Rail A Deep 1	106				
Magnetic Socket Rail A Imperial 1	104				
Magnetic Socket Rail B 4	125				
Magnetic Socket Rail B Deep 1	127				
Magnetic Socket Rail B Imperial 1	126				
Magnetic Socket Rail C 4	151				
Magnetic Socket Rail C Deep 1	149				
Magnetic Socket Rail C Impaktor 1	143				
Magnetic Socket Rail C Imperial 1	146				
Rack Kraftform	29				
Rack Kraftform Micro	29				
Safe-Torque A 1	395				
Safe-Torque A 1 Set 1	396				
Safe-Torque A 1 Imperial Set 1	396				
Safe-Torque A 1 SHK Set 1	397				
Safe-Torque A 2	395				
Safe-Torque A 2 Set 1	397				
Stubby Set 1	27				
Stubby Set 2	27				
Stubby Set 3	27				
Stubby Set TX 1	27				
T 1	372				
Tool-Check 1 SB	166				
Tool-Check Automotive 1	166				
Tool-Check PLUS	165				
Tool-Check PLUS Imperial	165				
Wera 2go 1	276				
Wera 2go 2	276				
Wera 2go 2 XL	277				
Wera 2go 3	277				
Wera 2go 4	277				
Wera 2go 5	277				
Wera 2go 6	278				
Wera 2go 7	278				
Wera 2go E 1	279				
Wera 2go H 1	278				
Wera 2go SHK 1	280				
Wheel Impaktor C Set 1	148				
Zyklop Hybrid Set	139				



**Wera Werkzeuge GmbH**  
Korzertter Straße 21-25  
42349 Wuppertal



+49 / (0)202 / 40 45 - 0

E-Mail: [info@wera.de](mailto:info@wera.de)



**Wera Tools Ibérica, S.L.**  
Avda. Corts Catalanes 2, Local 5  
08173 Sant Cugat del Vallès, Barcelona  
 +34/93/72 97 - 240  
E-Mail: [ventas@weraspain.com](mailto:ventas@weraspain.com)



**Wera Tools Finland Oy**  
Vanha Kaarelantie 33 A  
01610 Vantaa  
 +358 45 206 9556  
E-Mail: [ahokas@wera.de](mailto:ahokas@wera.de)



**Wera Outillages S.A.S.**  
13, rue Ampère  
F - 67500 Haguenau  
 +33 9 72 61 16 52  
E-Mail: [info@wera-outillages.fr](mailto:info@wera-outillages.fr)



**Wera Tools (UK) Ltd.**  
Railway View  
Clay Cross  
Chesterfield  
S45 9FR  
 +44 (0)1246 / 27 77 56  
Fax: +44 (0)1246 / 27 33 35  
E-Mail: [queries@wera-tools.co.uk](mailto:queries@wera-tools.co.uk)



**Wera Tools Inc.**  
3325 Harvester Rd., Unit 16  
Burlington, Ontario  
Canada, L7N 3N2  
 1-800-267-55 41



**Wera Tools Inc.**  
3325 Harvester Rd., Unit 16  
Burlington, Ontario  
Canada, L7N 3N2  
 1-800-267-55 41  
E-Mail: [info@weratools.com](mailto:info@weratools.com)



**NL - Noord**  
Frederik Koning  
 +31 / 615 26 36 97  
E-Mail: [koning@wera.de](mailto:koning@wera.de)



**Wera Tools Inc.**  
3325 Harvester Rd., Unit 16  
Burlington, Ontario  
Canada, L7N 3N2  
 1-800-267-55 41  
E-Mail: [info@weratools.com](mailto:info@weratools.com)



**Wera Tools Australia Pty Ltd**  
Australia  
 +61-435 755 123  
E-Mail: [mike.sack@wera.de](mailto:mike.sack@wera.de)

**NL - Zuid**  
Wouter Steijvers  
 +31 / 652 85 01 62  
E-Mail: [steijvers@wera.de](mailto:steijvers@wera.de)



**Wera Tools Japan G.K**  
2F, Eden Bldg.,  
1-10-8 Kamiikebukuro, Toshima-Ku,  
Tokyo, 170-0012 Japan  
東京都豊島区上池袋1-10-8  
エデンビル2階  
 +81-3-3915-2555  
E-Mail メール: [frank.yang@wera.de](mailto:frank.yang@wera.de)

**NL - Midden**  
Martijn van Houdt  
 +31 / 611 06 35 35  
E-Mail: [vanhoudt@wera.de](mailto:vanhoudt@wera.de)

**Demovan**  
Vincent van Gaalen  
 +31 / 615 44 37 19  
E-Mail: [vangaalen@wera.de](mailto:vangaalen@wera.de)

# Imprint

Subject to technical modifications!

Any reprinting – even only excerpts – shall only be permissible with the prior written consent of the company Wera Werkzeuge GmbH.

Edition: EN 1/2025

## Trademarks used:

ACR	Phillips Screw Company
ASSY	Adolf Würth GmbH & Co. KG
AW	Adolf Würth GmbH & Co. KG
HIOS	Totsu, Katsuyuki
Microstix	OSG System Products Co. Ltd.
Phillips Recess	Phillips Screw Company
Pozidriv	registered trademark for Phillips Screw Company in Canada, Mexico and in the USA; for Trifast plc in the UK
PZ	registered trademark for Phillips Screw Company in Canada, Mexico and in the USA
PZ1, PZ2, PZ3	registered trademark in the USA for Phillips Screw Company
PUK	Josef Haunstetter Sägenfabrik KG
Robertson	British Robertson S.L.U.
SDS plus	Robert Bosch GmbH
SIT	Adolf Würth GmbH & Co. KG
SPAX	Altenloh, Brinck & Co. GmbH & Co. KG
T-STAR plus	Altenloh, Brinck & Co. GmbH & Co. KG
TORQ-SET	Phillips Screw Company
TORX	Acutment Intellectual Properties, LLC, Troy, Mich., US
TORX PLUS	Acutment Intellectual Properties, LLC, Troy, Mich., US
TRI-WING	Phillips Screw Company
BESSEY®	BESSEY Tool GmbH & Co. KG
“KIRSCHEN”®	Wilh. Schmitt & Comp. GmbH & Co. KG
KNIPEX®	KNIPEX-Werk C. Gustav Putsch KG
COBRA®	KNIPEX-Werk C. Gustav Putsch KG
Lyra®	Johann Froescheis Lyra-Bleistift-Fabrik GmbH & Co. KG
PFERD	August Rüggeberg GmbH & Co. KG
PICARD®	Picard GmbH
RENNSTEIG	Rennsteig Werkzeuge GmbH
Stabila®	STABILA Messgeräte Gustav Ullrich GmbH

We reserve the right to modify without prior notification any details stated in this catalogue regarding product features, versions and designs.

No liability for printing errors or mistakes shall be assumed.



#### All regions (except for North America, UK and Republic of Ireland)

**Wera Werkzeuge GmbH**  
Germany

Korzarter Straße 21–25  
D-42349 Wuppertal  
Phone: +49 (0) 202 / 40 45-0

E-Mail: [info@wera.de](mailto:info@wera.de)

Internet: [www.wera.de](http://www.wera.de)

#### North America

**Wera Tools Inc.**  
3325 Harvester Rd., Unit 16  
Burlington, Ontario  
Canada, L7N 3N2

Phone: 1-800-267-55 41  
E-Mail: [info@weratools.com](mailto:info@weratools.com)

Internet: [www.weratools.com](http://www.weratools.com)

#### UK & Republic of Ireland

**Wera Tools (UK) Ltd.**  
Railway View  
Clay Cross  
Chesterfield  
S45 9FR

Phone: +44 (0)1246 / 27 77 56  
E-Mail: [queries@wera-tools.co.uk](mailto:queries@wera-tools.co.uk)

Internet: [www.wera-tools.co.uk](http://www.wera-tools.co.uk)  
Socials: [@weratoolsuk](https://www.instagram.com/weratoolsuk)