

# Verkstadsvagnar och skumgummiinsatser

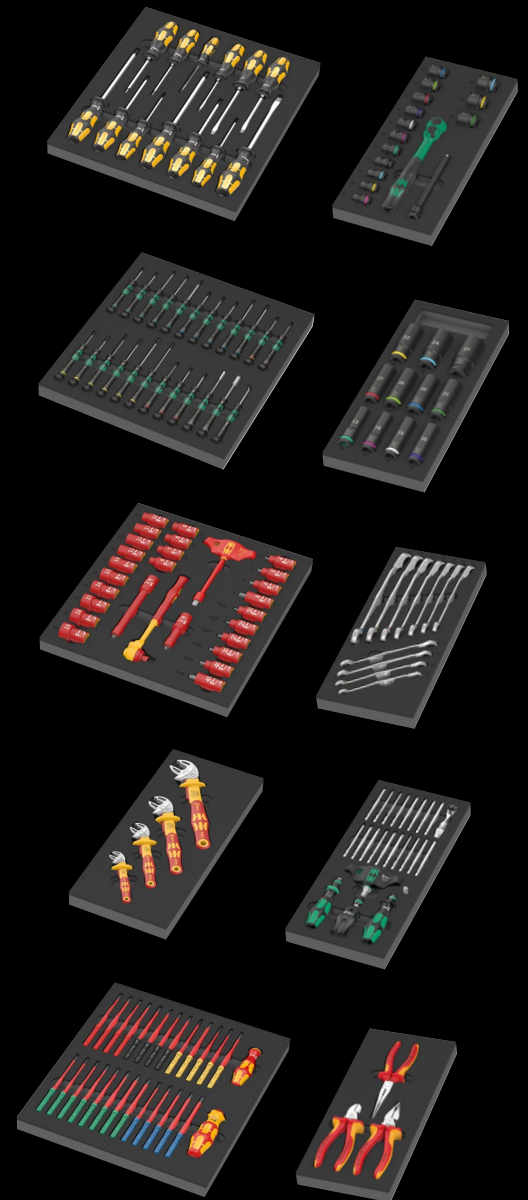

## Bestyckad verkstadsvagn med genial frontdesign i absolut toppkvalitet.

- Exklusiv verkstadsvagn i Tool Rebel-utförande
- Extremt robust utförande tack vare dubbelväggig konstruktion
- Med 7 lådor (5 platta, 2 höga) – varav 2 platta lådor bestyckade med skumgummiinsatser och verktyg
- Mått plana lådor (bredd x höjd x djup): 522 x 81 x 398 mm
- Mått höga lådor (bredd x höjd x djup): 522 x 166 x 398 mm
- Fullt utdragbar låda med kullagrade teleskopskenor, självstängande
- Alla lådor är individuellt laminerade med hög kvalitet
- Minimal tipprisk på grund av lådförregling – endast en låda kan öppnas i taget – inte flera samtidigt
- Högkvalitativa, hållbara skumgummiinsatser som inte avger kemiska ångor
- Optimal passform för smidigast möjliga uttagning av verktygen från skumgummiinsatserna





## 9700 Tool Rebel-verkstadvagn 1



Exklusiv verkstadvagn i Tool Rebel-utförande. 5 platta och 2 höga lådor säkerställer effektiv, mobil organisation av verktyg och material. Extremt robust utförande tack vare en dubbelväggig konstruktion och helsvetsad stomme. För daglig tuff verkstadsanvändning. Bestyckad med 4 Wera skumgummiinsats: 9710 skumgummiinsats skruvmejselsats 1, 9720 skumgummiinsats 8000 A Zyklop spärhandtagssats 1, 9731 skumgummiinsats 6003 Joker ring-U-nyckelsats 1, 9740 skumgummiinsats L-nyckelsats 1.

05150130001 1x 9700 Tool Rebel-verkstadvagn 1

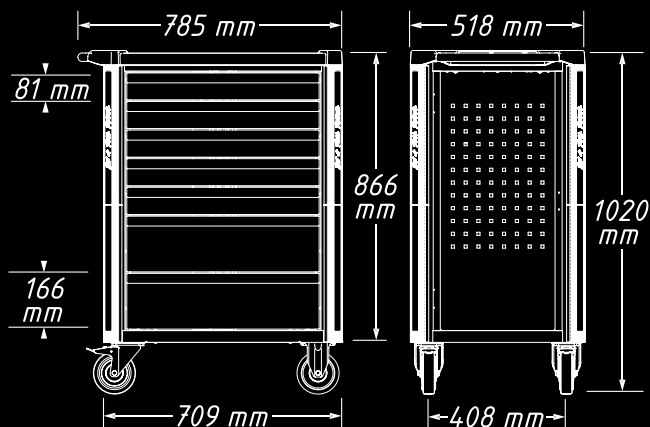

## Inklusive följande skumgummiinsatser:

9710



9720

1/4"

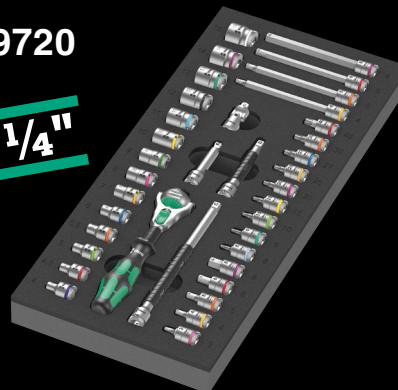

9731

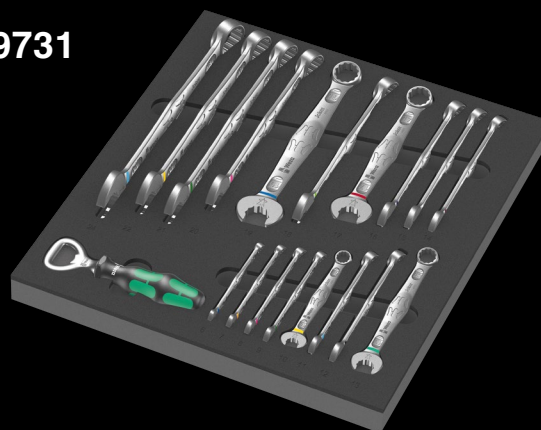

9740



## NYHET

### 9714 Skumgummiinsats skruv- och huggmejsel Skruvmejselsats 1

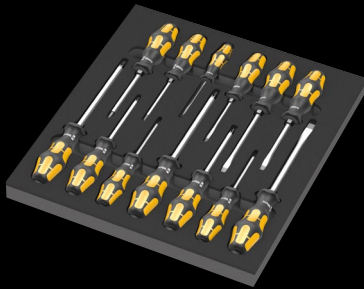

05150105001		
+	917 SPH	1x PH 1x80; 1x PH 2x100; 1x PH 3x150
+	918 SPZ	1x PZ 1x80; 1x PZ 2x100; 1x PZ 3x150
-	932 A	1x 0,6x3,5x80 <sup>1)</sup> ; 1x 0,8x4,5x90; 1x 1,0x5,5x100; 1x 1,2x7,0x125; 1x 1,6x9,0x150
+	977 TORX®	1x TX 20x90; 1x TX 25x100
	9814	1x 344,0x30,0x392,0

<sup>1)</sup> Ej genomgående klinga, slagyta och nyckelgrepp

## NYHET

### 9715 Skumgummiinsats skruvmejsel Kraftform Micro sats 1

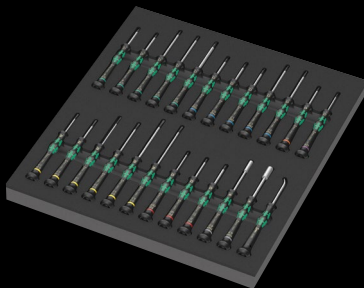

05150106001		
+	2050 Micro	1x PH 000x40 <sup>1) 2)</sup> ; 1x PH 00x40 <sup>1) 2)</sup> ; 1x PH 0x40 <sup>3)</sup>
+	2067 TORX® HF	1x TX 5x40; 1x TX 6x40; 1x TX 7x60; 1x TX 8x60; 1x TX 10x60
+	2067 TORX PLUS® IPR Micro	1x 1 IPRx40 <sup>4)</sup>
+	2072 Micro	1x mx40
○	2054 Micro	1x 0,7x40; 1x 0,9x40; 1x 1,3x40; 1x 1,5x60; 1x 2x60
-	2035 Micro	1x 0,23x1,5x40; 1x 0,30x1,8x60; 1x 0,35x2,5x40; 1x 0,40x2,0x60; 1x 0,40x2,5x80; 1x 0,50x3,0x80
●	2069 Micro	1x 4,0x60; 1x 5,5x60
●	1429	1x 1,0x3,5x50
	9815	1x 344,0x30,0x392,0

<sup>1)</sup> Optimerad för den asiatiska versionen av Phillips-skrivar

<sup>2)</sup> I fattningsändan är klingan nedsvarvad till nominellt mått på en sträcka av 10 mm

<sup>3)</sup> Storlek 0 modifierad enligt JCIS 0 (Japanese Camera Industrial Standard)

<sup>4)</sup> Utan hål

## NYHET

### 9726 Skumgummiinsats 8007 B VDE Zyklop VDE spärrhandtagssats 1, 3/8"



05150116001		
○	8007 B VDE	1x 3/8"x222,0
○	410 i VDE B	1x 3/8"x130
●	8790 B VDE	1x 6,0x46,0; 1x 7,0x46,0; 1x 8,0x46,0; 1x 9,0x46,0; 1x 10,0x46,0; 1x 11,0x46,0; 1x 12,0x46,0; 1x 13,0x46,0; 1x 14,0x46,0; 1x 15,0x46,0; 1x 16,0x46,0; 1x 17,0x46,0; 1x 18,0x46,0; 1x 19,0x46,0
+	8767 B VDE HF	1x TX 20x55,0; 1x TX 25x55,0; 1x TX 27x55,0; 1x TX 30x55,0; 1x TX 40x55,0; 1x TX 45x59,0
○	8740 B VDE HF	1x 4,0x55,0; 1x 5,0x55,0; 1x 6,0x55,0; 1x 8,0x59,0
○	8794 SB VDE	1x 3/8"x91,0
○	8794 LB VDE	1x 3/8"x166,0
	9826	1x 344,0x30,0x392,0

## NYHET

### 9734 Skumgummiinsats 6004 Joker VDE sats 1



05150124001		
	6004 Joker VDE XS	1x 7-10 (1/4"-3/8")x119
	6004 Joker VDE S	1x 10-13 (7/16"-1/2")x155
	6004 Joker VDE M	1x 13-16 (1/2"-5/8")x190
	6004 Joker VDE L	1x 16-19 (5/8"-3/4")x226
	9834	1x 172,0x30,0x392,0

Obs: Skumgummiinsatserna passar inte i den tidigare modellen 05501051001 av verkstadsvagnen.

## NYHET

### 9751 Skumgummiinsats Kraftform Kompakt VDE sats 1

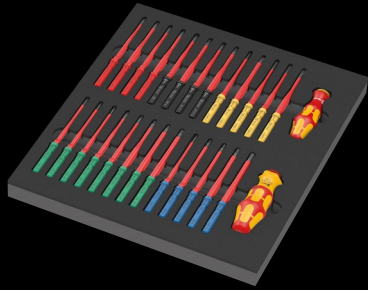

05150151001		
●	837 i RA	1x 9x115
●	817 VDE	1x 9x98
⊕	Kraftform Kompakt VDE 62 iS Take it easy	1x PH 1x157; 1x PH 2x157
⊕	Kraftform Kompakt VDE 65 iS Take it easy	1x PZ 1x157; 1x PZ 2x157
⊕	Kraftform Kompakt VDE 62 iS PH/S Take it easy	1x # 1x157; 1x # 2x157
⊕	Kraftform Kompakt VDE 65 iS PZ/S Take it easy	1x # 1x157; 1x # 2x157
⊕	Kraftform Kompakt VDE 67 i Take it easy	1x TX 8x157; 1x TX 9x157; 1x TX 10x157; 1x TX 27x157; 1x TX 30x157
⊕	Kraftform Kompakt VDE 67 iS Take it easy	1x TX 15x157; 1x TX 20x157; 1x TX 25x157
○	Kraftform Kompakt VDE 64 i Take it easy	1x 2,5x157; 1x 3,0x157; 1x 4,0x157; 1x 5,0x157; 1x 6,0x157
⊖	Kraftform Kompakt VDE 60 iS Take it easy	1x 0,6x3,5x157; 1x 0,8x4,0x157; 1x 1,0x5,5x157
⊖	Kraftform Kompakt VDE 60 i Take it easy	1x 0,4x2,5x157; 1x 1,2x6,5x157
	9851	1x 344,0x30,0x392,0

## NYHET

### 9724 Skumgummiinsats 8010 B Zyklus Comfort spärhandtagssats 1, 3/8"



05150114001		
○	8010 B	1x 3/8"x230,0
●	8790 B Impaktor	1x 8,0x30,0; 1x 10,0x30,0; 1x 11,0x30,0; 1x 12,0x30,0; 1x 13,0x30,0; 1x 14,0x30,0; 1x 15,0x30,0; 1x 16,0x30,0; 1x 17,0x30,0; 1x 18,0x30,0; 1x 19,0x30,0; 1x 21,0x32,0; 1x 22,0x32,0; 1x 24,0x32,0
⊕	8798 B	1x 3/8"x152,4
	9824	1x 172,0x30,0x392,0

## NYHET

### 9725 Skumgummiinsats Zyklus C, 1/2", Impaktor Deep hylsmejselinsats-sats 1

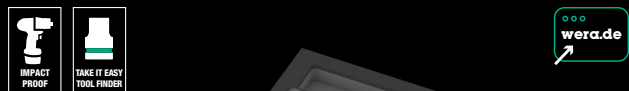

05150115001		
●	8790 C Impaktor Deep	1x 13,0x83,0; 1x 14,0x83,0; 1x 15,0x83,0; 1x 16,0x83,0; 1x 17,0x83,0; 1x 18,0x83,0; 1x 19,0x83,0; 1x 21,0x83,0; 1x 22,0x83,0; 1x 24,0x83,0; 1x 27,0x83,0
	9825	1x 172,0x30,0x392,0

## NYHET

### 9733 Skumgummiinsats 6001 Joker Switch sats 1

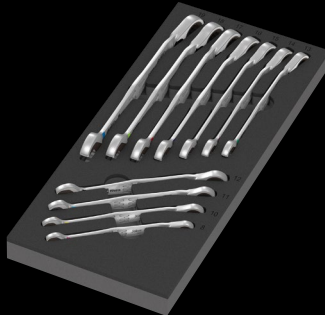

05150123001	
6001 Joker Switch	1x 8x144; 1x 10x159; 1x 11x165; 1x 12x171; 1x 13x179; 1x 14x187; 1x 15x199; 1x 16x213; 1x 17x225; 1x 18x234; 1x 19x246
9833	1x 172,0x30,0x392,0

## NYHET

### 9784 Skumgummiinsats KNIPEX tångsats VDE 1



05150184001	
KNIPEX sidavbitare 70 06 160	
KNIPEX radiotång med avbitarfunktion (spetstång) 26 16 200	
KNIPEX spetsig kombitång 08 26 185	
9884	1x 172,0x30,0x392,0

## NYHET

### 9752 Skumgummiinsats Kraftform Kompakt spärhandtagssats 1



1/4"

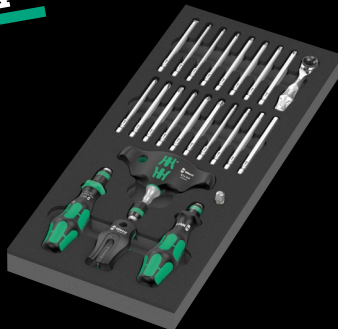

05150152001	
838 RA-R M	1x 1/4"x123,5
416 RA	1x 1/4"x45
816 R	1x 1/4"x119
8001 A	1x 1/4"x87,0
851/4 Z	1x PH 1x89; 1x PH 2x89; 1x PH 3x89 <sup>1)</sup>
855/4 Z	1x PZ 1x89; 1x PZ 2x89; 1x PZ 3x89 <sup>1)</sup>
867/4 Z TORX®	1x TX 10x89; 1x TX 15x89; 1x TX 20x89; 1x TX 25x89; 1x TX 27x89; 1x TX 30x89; 1x TX 40x89
840/4 Z	1x 3,0x89; 1x 4,0x89; 1x 5,0x89; 1x 6,0x89 <sup>1)</sup>
800/4 Z	1x 1,0x5,5x89
870/1	1x 1/4"x25 <sup>2)</sup>
9500	1x 64,6
9852	1x 172,0x30,0x392,0

<sup>1)</sup> Sexkantsklinga

<sup>2)</sup> Med kula, för handmanövrerade hylsmejselinsatser

### 9710 Skumgummiinsats skruvmejselsats 1



05150101001	
932 A	1x 1,0x5,5x100; 1x 1,2x7,0x125
350 PH	1x PH 1x80; 1x PH 2x100; 1x PH 3x150
350 PH Stubby	1x PH 2x25
355 PZ	1x PZ 1x80; 1x PZ 2x100
335	1x 0,8x4,0x100; 1x 1,0x5,5x125
334	1x 1,2x6,5x150
335 Stubb-skruvmejsel	1x 1,0x5,5x24,5
2050 Micro	1x PH 0x40 <sup>1)</sup>
2035 Micro	1x 0,40x2,5x80
160 i VDE	1x 0,4x2,5x80 <sup>2)</sup> ; 1x 0,6x3,5x100 <sup>2)</sup>
1441	1x 4,5-6,0x41,0
1442	1x 6,0-8,5x41,0
9810	1x 344,0x30,0x392,0

<sup>1)</sup> Storlek 0 modifierad enligt JCIS 0 (Japanese Camera Industrial Standard)

<sup>2)</sup> ej Lasertip

## 9711 Skumgummiinsats VDE-skruvmejselsats 1

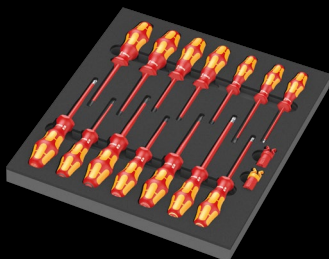

05150102001	
+	<b>162 iS PH VDE</b> 1x PH 1x80; 1x PH 2x100
+	<b>165 iS PZ VDE</b> 1x PZ 1x80; 1x PZ 2x100
+	<b>165 i PZ/S VDE</b> 1x # 2x100
-	<b>160 i VDE</b> 1x 0,4x2,5x80 <sup>1)</sup> ; 1x 0,8x4,0x100; 1x 1,0x5,5x125
-	<b>160 iS VDE</b> 1x 0,6x3,5x100
+	<b>167 i TORX® VDE</b> 1x TX 10x80; 1x TX 15x80; 1x TX 20x80; 1x TX 25x100; 1x TX 30x100
	<b>1440</b> 1x 4,5-6,0x41,0
	<b>1442</b> 1x 6,0-8,5x41,0
	<b>9811</b> 1x 344,0x30,0x392,0

<sup>1)</sup> ej Lasertip

## 9713 Skumgummiinsats sexkantsskruvmejselsats 1

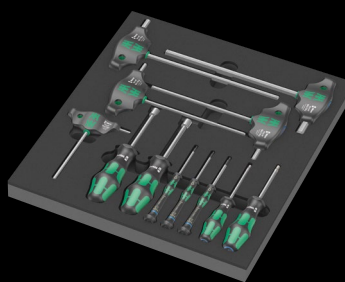

05150104001	
○	<b>354</b> 1x 3,0x75; 1x 4,0x75
○	<b>2054 Micro</b> 1x 1,5x60; 1x 2x60; 1x 2,5x60
○	<b>454 HF</b> 1x 4x100; 1x 5x100; 1x 6x150; 1x 8x200; 1x 10x200
●	<b>395 H0</b> 1x 10,0x90; 1x 13,0x90
	<b>9813</b> 1x 344,0x30,0x392,0

## 9720 Skumgummiinsats 8000 A Zyklop spärrhandtag 1/4" sats 1



## 9712 Skumgummiinsats TORX® HF-skruvmejselsats 1

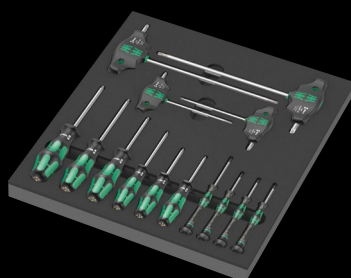

05150103001	
+	<b>367 TORX® HF</b> 1x TX 8x60; 1x TX 9x60; 1x TX 10x80; 1x TX 15x80; 1x TX 20x100; 1x TX 25x100
+	<b>2067 TORX® HF</b> 1x TX 4x40; 1x TX 5x40; 1x TX 6x40; 1x TX 7x60
+	<b>467 TORX® HF</b> 1x TX 20x100; 1x TX 25x100; 1x TX 30x200; 1x TX 40x200
	<b>9812</b> 1x 344,0x30,0x392,0

05150110001	
○	<b>8000 A</b> 1x 1/4"x152,0
●○	<b>8794 LA</b> 1x 1/4"x150,0
●○	<b>8794 SA</b> 1x 1/4"x75,0
●○	<b>8795 A</b> 1x 1/4"x35,5
●○	<b>8794 A</b> 1x 1/4"x56,0
●	<b>8790 HMA</b> 1x 4,0x23,0; 1x 4,5x23,0; 1x 5,0x23,0; 1x 5,5x23,0; 1x 6,0x23,0; 1x 7,0x23,0; 1x 8,0x23,0; 1x 9,0x23,0; 1x 10,0x23,0; 1x 11,0x23,0; 1x 12,0x23,0; 1x 13,0x23,0; 1x 14,0x23,0; 1x 15,0x23,0
+	<b>8767 A HF</b> 1x TX 8x28,0; 1x TX 9x28,0; 1x TX 10x28,0; 1x TX 15x28,0; 1x TX 20x28,0; 1x TX 25x28,0; 1x TX 27x28,0; 1x TX 30x28,0; 1x TX 40x28,0
○	<b>8740 A HF</b> 1x 3,0x28,0; 1x 4,0x28,0; 1x 4,0x100,0; 1x 5,0x28,0; 1x 5,0x100,0; 1x 6,0x28,0; 1x 6,0x100,0; 1x 8,0x28,0; 1x 8,0x100,0
	<b>9820</b> 1x 172,0x30,0x392,0



## 9721 Skumgummiinsats 8000 B Zyklop spærrhandtag 3/8" sats 1



05150111001		
○	8000 B	1x 3/8"x199,0
●○	8794 SB	1x 3/8"x125,0
●○	8794 LB	1x 3/8"x200,0
●○	8795 B	1x 3/8"x50,0
●○	8794 B	1x 3/8"x76,0
●	8790 HMB	1x 6,0x29,0; 1x 7,0x29,0; 1x 8,0x29,0; 1x 9,0x29,0; 1x 10,0x29,0; 1x 11,0x29,0; 1x 12,0x29,0; 1x 13,0x29,0; 1x 14,0x29,0; 1x 15,0x29,0; 1x 16,0x30,0; 1x 17,0x30,0; 1x 18,0x30,0; 1x 19,0x30,0; 1x 20,0x30,0; 1x 21,0x30,0; 1x 22,0x30,0; 1x 24,0x32,0
	9821	1x 172,0x30,0x392,0

## 9723 Skumgummiinsats Zyklop B 3/8"-bitshylssats 1



05150113001		
●●	8784 B1	1x 1/4"x3/8"x44,0
⊗	8767 B HF	1x TX 15x35,0; 1x TX 20x35,0; 1x TX 25x35,0; 1x TX 25x107,0; 1x TX 27x35,0; 1x TX 27x107,0; 1x TX 30x35,0; 1x TX 30x107,0; 1x TX 40x35,0; 1x TX 40x107,0
○	8740 B HF	1x 4,0x35,0; 1x 4,0x107,0; 1x 5,0x35,0; 1x 5,0x107,0; 1x 6,0x35,0; 1x 6,0x107,0; 1x 7,0x38,5; 1x 8,0x38,5; 1x 8,0x100,0; 1x 10,0x38,5; 1x 10,0x100,0
	9823	1x 172,0x30,0x392,0

## 9722 Skumgummiinsats 8000 C Zyklop spærrhandtag 1/2" sats 1



05150112001		
○	8000 C	1x 1/2"x277,0
●○	8794 LC	1x 1/2"x250,0
●○	8794 SC	1x 1/2"x125,0
●○	8795 C	1x 1/2"x69,0
●○	8794 C	1x 1/2"x52,0
●	8790 HMC	1x 10,0x37,0; 1x 11,0x37,0; 1x 12,0x37,0; 1x 13,0x37,0; 1x 14,0x37,0; 1x 15,0x37,0; 1x 16,0x37,0; 1x 17,0x37,0; 1x 18,0x37,0; 1x 19,0x37,0; 1x 20,0x37,0; 1x 21,0x37,0; 1x 22,0x37,0; 1x 24,0x37,0; 1x 27,0x40,0; 1x 30,0x42,0; 1x 32,0x42,0
○	8740 C HF	1x 4,0x60,0; 1x 4,0x140,0; 1x 5,0x60,0; 1x 5,0x140,0; 1x 6,0x60,0; 1x 6,0x140,0; 1x 7,0x60,0; 1x 8,0x60,0; 1x 10,0x60,0
	9822	1x 344,0x30,0x392,0

## 9730 Skumgummiinsats 6000 Joker sats 1



05150120001		
	6000 Joker	1x 8x144; 1x 10x159; 1x 11x165; 1x 12x170,7; 1x 13x177; 1x 14x188; 1x 15x200; 1x 16x212; 1x 17x224; 1x 18x235; 1x 19x246
	9830	1x 172,0x30,0x392,0

## 9731 Skumgummiinsats 6003 Joker sats 1

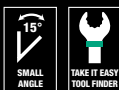

05150121001	
<b>6003 Joker</b>	1x 6x105; 1x 7x110; 1x 8x115; 1x 9x120; 1x 10x125; 1x 11x135; 1x 12x148; 1x 13x160; 1x 14x167; 1x 15x174; 1x 16x182; 1x 17x190; 1x 18x210; 1x 19x230,0; 1x 20x230,0; 1x 21x260; 1x 22x260; 1x 24x280
<b>Flasköppnare</b>	1x 148
<b>9831</b>	1x 344,0x30,0x392,0

## 9732 Skumgummiinsats 6004 Joker sats 1



05150122001	
<b>6004 Joker XS</b>	1x 7-10 (1/4"-3/8")x117
<b>6004 Joker S</b>	1x 10-13 (7/16"-1/2")x154
<b>6004 Joker M</b>	1x 13-16 (1/2"-5/8")x188
<b>6004 Joker L</b>	1x 16-19 (5/8"-3/4")x224
<b>6004 Joker XL</b>	1x 19-24x (3/4"-15/16")x256
<b>9832</b>	1x 172,0x30,0x392,0

## 9740 Skumgummiinsats L-nyckelsats 1

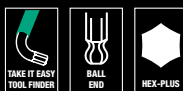

05150140001	
<b>950/9 Hex-Plus Multicolour 1</b>	1x 1.5x90; 1x 2.0x101; 1x 2.5x112; 1x 3.0x123; 1x 4.0x137; 1x 5.0x154; 1x 6.0x172; 1x 8.0x195; 1x 10.0x224
<b>967/9 TX XL Multicolour 1</b>	1x TX 8x90; 1x TX 9x101; 1x TX 10x112
<b>967 SPKXL TORX® Multicolour</b>	1x TX 15x123; 1x TX 20x137; 1x TX 25x154; 1x TX 27x172; 1x TX 30x195; 1x TX 40x224
<b>9500</b>	1x 64,6
<b>STABILA® måttband BM 100, 3 m, artikelnr 19570</b>	1x 3000,0
<b>9840</b>	1x 172,0x30,0x392,0

## 9750 Skumgummiinsats Kraftform Kompakt och Tool-Check PLUS sats 1



05150150001	
<b>1x Tool-Check PLUS</b>	
● <b>8001 A</b>	1x 1/4"x87.0
● <b>813</b>	1x 1/4"x78
● <b>889/4/1 K</b>	1x 1/4"x50
○ <b>870/1</b>	1x 1/4"x25 <sup>1)</sup>
● <b>8790 HMA</b>	1x 5.5x23.0; 1x 6.0x23.0; 1x 7.0x23.0; 1x 8.0x23.0; 1x 10.0x23.0; 1x 12.0x23.0; 1x 13.0x23.0
⊕ <b>851/1 TZ</b>	2x PH 1x25; 3x PH 2x25; 1x PH 3x25
⊕ <b>855/1 TH</b>	1x PZ 1x25; 3x PZ 2x25; 1x PZ 3x25
⊕ <b>867/1 TZ TORX®</b>	1x TX 10x25; 1x TX 15x25; 1x TX 20x25; 1x TX 25x25; 1x TX 30x25; 1x TX 40x25
⊕ <b>867/1 Z TORX® BO</b>	1x TX 10x25; 1x TX 15x25; 1x TX 20x25; 1x TX 25x25; 1x TX 30x25
○ <b>840/1 Z</b>	1x 3.0x25; 1x 4.0x25; 1x 5.0x25; 1x 6.0x25; 1x 8.0x25
⊖ <b>800/1 TZ</b>	1x 1.0x5.5x25
<b>1x Kraftform Kompakt 60</b>	
● <b>816 R</b>	1x 1/4"x119
⊕ <b>851/4 Z</b>	1x PH 1x89; 1x PH 2x89; 1x PH 3x89 <sup>2)</sup>
⊕ <b>855/4 Z</b>	1x PZ 1x89; 1x PZ 2x89; 1x PZ 3x89 <sup>2)</sup>
⊕ <b>867/4 Z TORX® BO</b>	1x TX 10x89; 1x TX 15x89; 1x TX 20x89; 1x TX 25x89; 1x TX 30x89
⊖ <b>800/4 Z</b>	1x 1.0x5.5x89
○ <b>840/4 Z</b>	1x 3.0x89; 1x 4.0x89; 1x 5.0x89; 1x 6.0x89 <sup>2)</sup>
<b>Kardborreband 70</b>	1x 50.0x70.0
<b>1x 393 S</b>	
●	1x 1/4"x173,5
<b>1x 9850</b>	
	1x 172,0x30,0x392,0

<sup>1)</sup> Med kula, för handmanövrerade hylseinsatser

<sup>2)</sup> Sexkantsklinga

## 9780 Skumgummiinsats KNIPEX-tänger sats 1



05150180001		
	KNIPEX Kombinationstång 03 05 180	1x 180
	KNIPEX Cobra® Hightech polygriptång 87 05 250	1x 250
	KNIPEX Kraftsidavbitare 74 05 160	1x 160
	9880	1x 172,0x30,0x392,0

## 9782 Skumgummiinsats hammar sats 1



05150182001		
	PICARD® smideshammare 500 g, 0000101-500	1x 500,0
	RENNSTEIG Drivdorn Exklusiv	1x 452 003 6 RC, 3,0x150; 1x4520046RC, 4,0x150; 1x4520066RC, 6,0x150; 1x 452 008 6 RC, 8,0x150
	RENNSTEIG Flatmejsel 310 250 1	1x 25,0x13,0x23,0
	9882	1x 172,0x30,0x392,0

## 9781 Skumgummiinsats KNIPEX-tänger sats 2

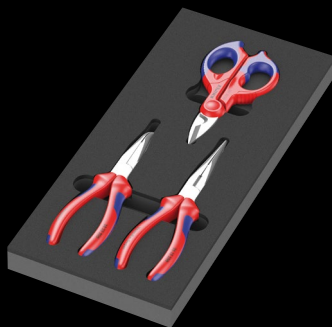

05150181001		
	KNIPEX Tång med flata, runda käftar och skär (Typ storknäbb) 26 15 200	1x 200
	KNIPEX Mekanikertång 38 25 200	1x 200
	KNIPEX Elektrikersax 95 05 155	1x 155
	9881	1x 172,0x30,0x392,0

## 9783 Skumgummiinsats PFERD filsats 1

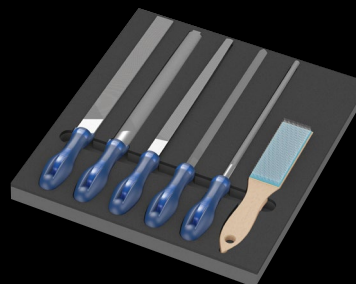

05150183001		
	PFERD verkstadsfil fyrkant PF1142 250 H2	1x 250
	PFERD verkstadsfil halvrund spetsig 1152SP 250 H2	1x 250
	PFERD verkstadsfil rund 1162 250 H2	1x 250
	PFERD verkstadsfil plan 1112 250 H2	1x 250
	PFERD verkstadsfil trekant 1132 250 H2	1x 250
	PFERD filsborste HBF ståltråd Ø 0,15	1x 232
	9883	1x 344,0x30,0x392,0

Vi förbehåller oss rätten att ändra all information i denna broschyr när det gäller produkttegenskaper, varianter och utföranden, när som helst och utan föregående meddelande. Vi åtar oss inget ansvar för feltryck eller felaktig information.



Wera Werkzeuge GmbH  
Korzelter Straße 21-25  
D-42349 Wuppertal

Phone: +49 (0)202/4045-0  
E-Mail: [info@wera.de](mailto:info@wera.de)  
[www.wera.de](http://www.wera.de)